



**DENTAL**

**GLH** SURGICAL GROUP  
ENTERPRISES INC.

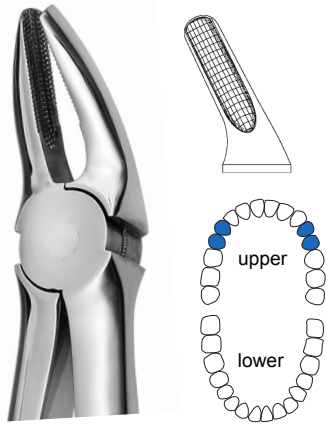

Fig. 7

**LS-245-007**

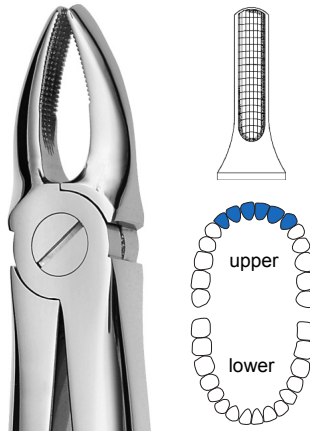

Fig. 2

**LS-245-002**



Fig. 4

**LS-245-004**



Fig. 13

**LS-245-013**

# Extraction

( American Pattern )

# Extracción

( patrón americano )

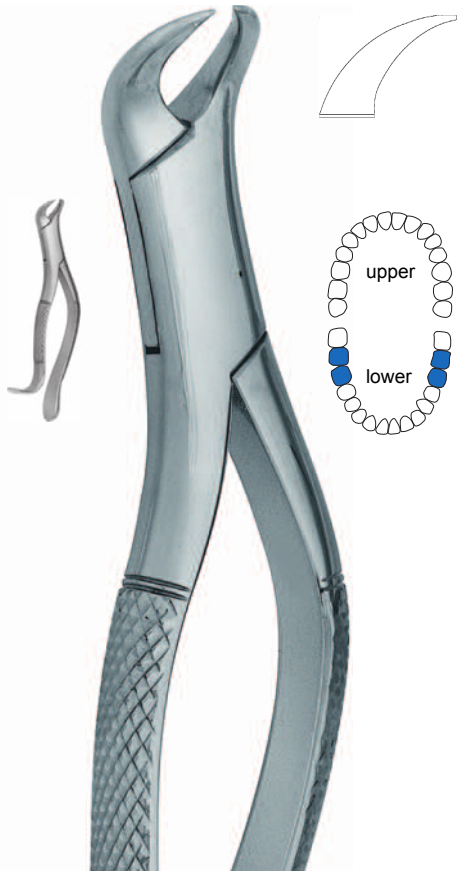

Fig. 16

LS-250-016

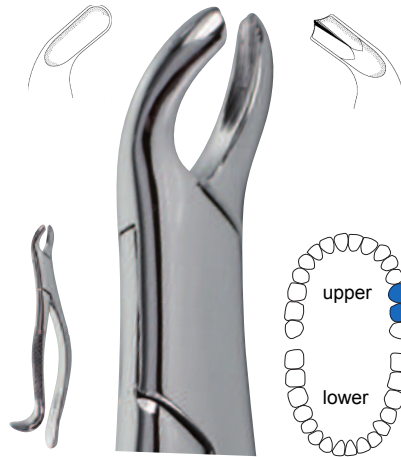

Fig. 18L

LS-250-18L



Fig. 18R

LS-250-18R

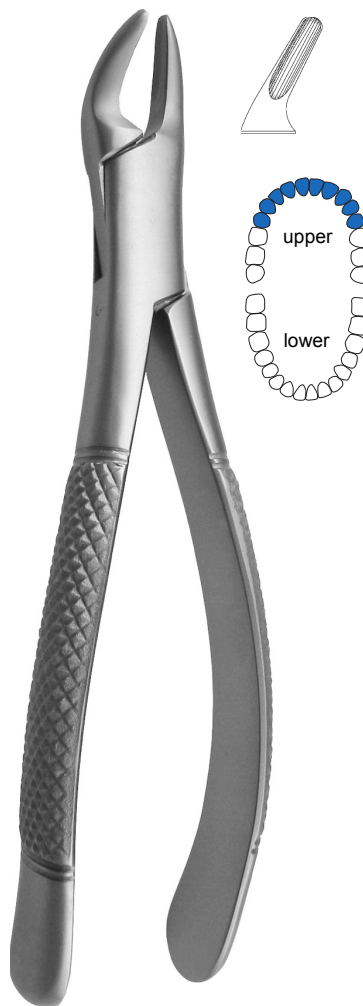

Fig. 150S  
CHILDREN

LS-250-150C



Fig. 286

LS-250-286



Fig. 151S  
CHILDREN

LS-250-151C

# Elevators

## Elevadores

**CRYER**  
Fig. 27  
**LS-200-027**



**CRYER**  
Fig. 28  
**LS-200-28**



**APICAL**  
Fig. 301  
**LS-205-301**



**APICAL**  
Fig. 302  
**LS-205-302**



**APICAL**  
Fig. 303  
**LS-205-303**



**LUXIAL**  
straight  
3 mm  
**LS-215-3ST**



**LUXIAL**  
curved  
3 mm  
**LS-215-3CV**



**LUXIAL**  
straight  
5 mm  
**LS-215-5ST**



**LUXIAL**  
curved  
5 mm  
**LS-215-5CV**



**Bayonet**  
straight  
**LS-210-STR**



**Bayonet**  
curved  
**LS-210-CVD**



**Bayonet**  
offset in  
**LS-210-OIN**



**Bayonet**  
offset out  
**LS-210-OOT**



**Bayonet**  
offset left  
**LS-210-OLF**



**Bayonet**  
offset right  
**LS-210-ORT**





# Periosteal Elevators

Elevadores perióstico



**BUSER**  
LS-260-001



**MOLT**  
Fig. 2/4  
LS-260-2-4



**MOLT**  
Fig. 9  
LS-260-009

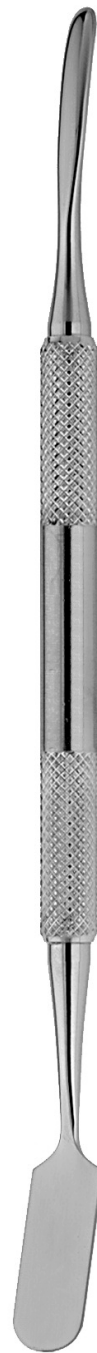

**PRICHARD**  
LS-260-100



**SELDIN**  
Fig. 23  
LS-260-S23



Fig. 1

LS-220-001  
LS-225-001



Fig. 2

LS-220-002  
LS-225-002



Fig. 3

LS-220-003  
LS-225-003



Fig. 3A

LS-220-03A  
LS-225-03A



Fig. 6

LS-220-006  
LS-225-006



Fig. 8

LS-220-008  
LS-225-008



Fig. 9

LS-220-009  
LS-225-009

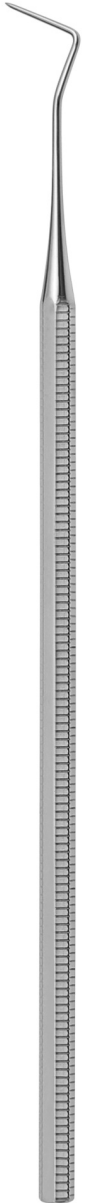

fine & flexible tip



Fig. 11

LS-220-011  
LS-225-011



Fig. 17

LS-220-017  
LS-225-017



Fig. 23

LS-220-023  
LS-225-023



Fig. 35

LS-220-035  
LS-225-035

Mirror handles



hollow  
stainless



solid  
stainless

Mirror inserts micro



Ø 3mm

LS-240-001



Ø 5mm

LS-240-002

Mirror inserts plane

(Box of 10)

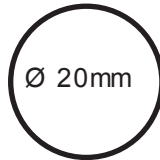

Ø 20mm

LS-240-100

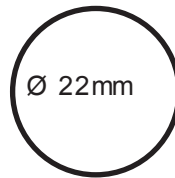

Ø 22mm

LS-240-101



LS-240-201 LS-240-202

LS-220-..... LS-225-.....

**Diagnostic**  
**Diagnóstico**



**LS-230-.....**

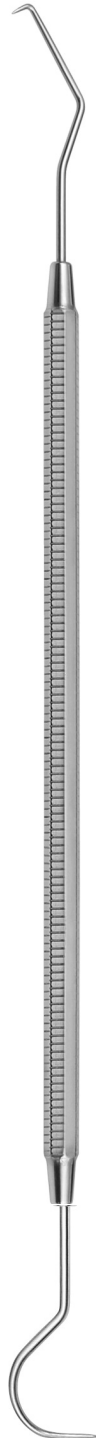

**LS-235-.....**



**Fig. 2**

**LS-230-002**  
**LS-235-002**



**Fig. 3**

**LS-230-003**  
**LS-235-003**



**Fig. 5**

**LS-230-005**  
**LS-235-005**

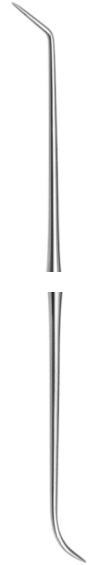

**Fig. 6**

**LS-230-006**  
**LS-235-006**



**Fig. 8-9**

**LS-230-8-9**  
**LS-235-8-9**

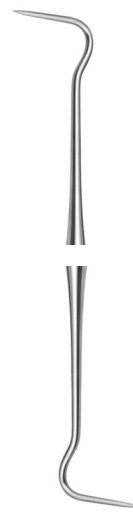

**Fig. 8**

**LS-230-008**  
**LS-235-008**



**Fig. 9**

**LS-230-009**  
**LS-235-009**



**Fig. 11**

**LS-230-011**  
**LS-235-011**

# Kerrison & Rongeurs

Kerrison y pinzas gubias



**LUER-FRIEDMANN**  
13,0 cm; 5 1/8"  
196-203-14



**BLUMENTHAL**



15,5 cm; 6"  
196-225-30



15,5 cm; 6"  
196-225-45



14,5 cm; 5 3/4"  
196-225-90



**MEAD**  
16,5 cm; 6 1/2"  
196-215-01



	3,0 mm	<b>111-506-03</b>
	4,0 mm	<b>111-506-04</b>
	5,0 mm	<b>111-506-05</b>
	6,0 mm	<b>111-506-06</b>



196-319-18



196-317-18



**BEYER**  
18,0 cm; 7"



# Bone Instruments

## Instrumentos hueso

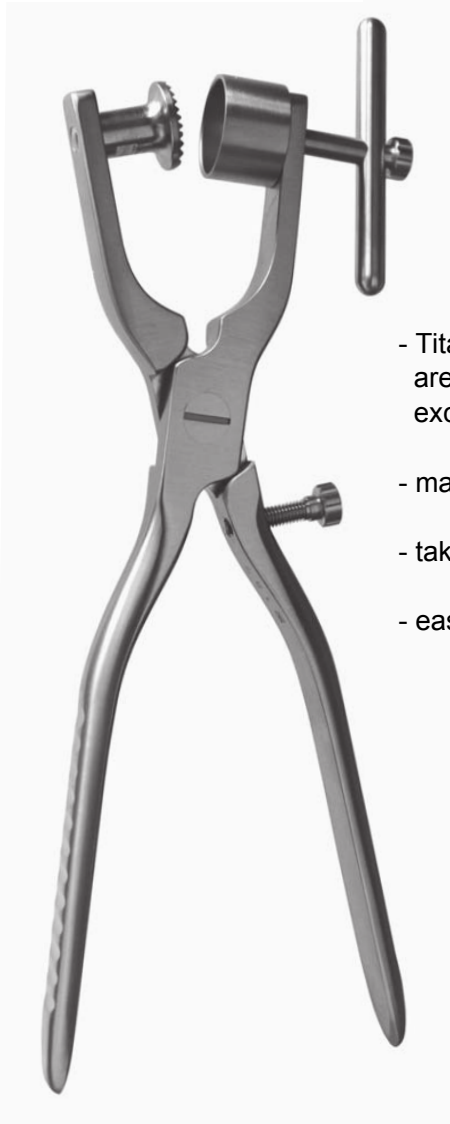

Bone mill Forceps for the preparation of autologous bone material

**LS-190-001**

- Titanium Bone Mill inserts are detachable and exchangeable
- maximum milling results
- take apart inserts
- easy to clean



Bone Scraper, straight stainless steel

**LS-195-001**



Spare Blade straight

**LS-195-002**

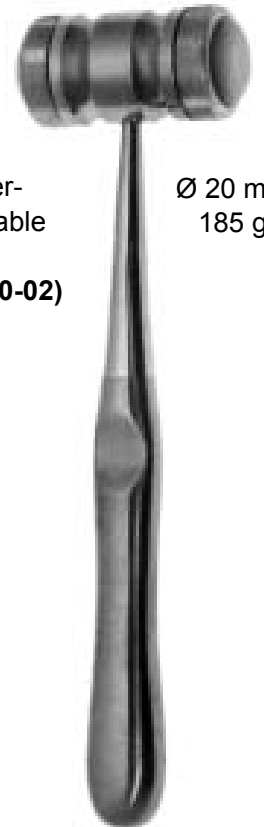

with interchangeable disks  
(191-240-02)

Ø 20 mm  
185 g

**MEAD**

19,0 cm; 7 1/2"  
**191-240-17**



Manual Bone Mill  
Titanium

**LS-190-002**



Non Slip  
Graft Material Bowl

**LS-255-001**

# Graft Material Instruments

Instrumentos materiales de injerto



Syringes

- Ø 2,5 mm; **LS-265-025**
- Ø 3,5 mm; **LS-265-035**
- Ø 4,5 mm; **LS-265-045**
- Ø 6,0 mm; **LS-265-060**



Spoon & Packer

**LS-265-100**



Packer  
serrated / small

**LS-265-101**



Packer  
serrated / large

**LS-265-102**

# Retractors Separadores



**MOLT**

**LS-100-001** 12,0 cm for children  
**LS-100-002** 14,0 cm for adults



1 pair of silicone inserts  
**LS-105-002**

**DENHART**  
**LS-105-001**



**WIEDER**

Tongue depressor

**LS-110-001** small  
**LS-110-002** large



**FARABEUF**

Set of 2ea

**LS-115-001** 12,5 cm  
**LS-115-002** 15,0 cm



**AUSTIN**

**LS-120-001**



**STERNBERG**

Lip Retractor; 14,0 cm

**LS-160-001**



Vestibulum and  
Cheek Retractor

**LS-165-001**



Tongue Holder

**LS-170-001**



**SCHÄFER**

23,0 cm

**LS-185-001**

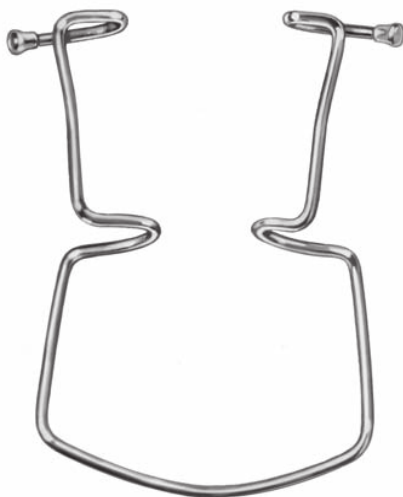

**ORINGER**

Selfretaining cheek-lip retractor

**LS-175-001** small  
**LS-175-002** medium  
**LS-175-003** large



**HILGER**

Retractor with handle

**LS-180-001**



# Retractors

Separadores



**MIDDELDORPF**

Cheek Retractor

**LS-125-001** 17,0 cm

**LS-125-002** 22,0 cm



**BUCHWALD**

Tongue Depressor

**LS-130-001** 18,0 cm



**CAWOOD - MINNESOTA**

**LS-135-001** 16,0 cm



**MINNESOTA**

**LS-135-002** 16,0 cm



**MATY**

**LS-140-001** 17,0 cm



**RIDGE**

measuring caliper for bone width  
scale both sides 0-25 mm

**LS-145-001**



**CASTROVIEJO**

caliper measures 0-40 mm  
straight; 9,0 cm long

**100-231-40**



**CASTROVIEJO**

caliper measures 0-40 mm  
30° angled; 9,0 cm long

**LS-155-002**



**CASTROVIEJO**

caliper measures 0-40 mm  
18,0 cm long

**LS-155-004** 30° angled  
**100-232-40** straight



**Bone Thickness Gauge**

measures 0-40 mm  
18,0 cm long

**LS-145-002**



**CASTROVIEJO**

caliper measures 0-20 mm  
round tip; 9,0 cm long

**LS-155-003**

# Calipers

## Calibres



Digital Caliper  
0 - 150 mm

**LS-150-001**

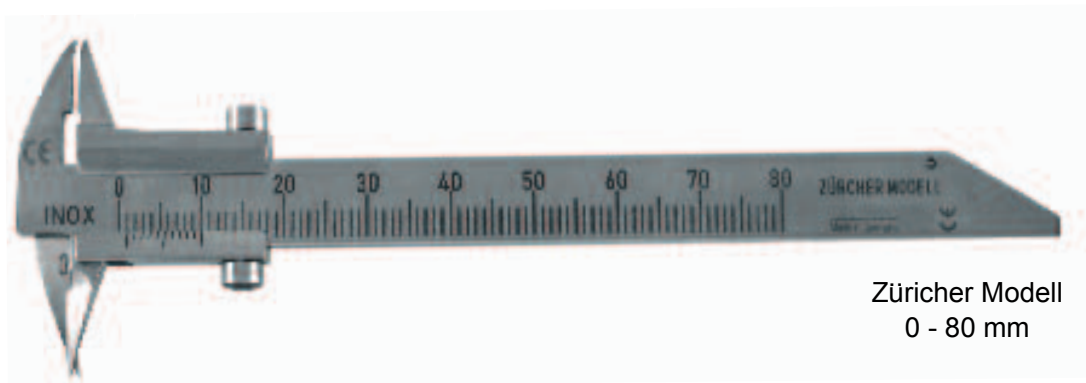

Zürcher Modell  
0 - 80 mm

**LS-150-002**

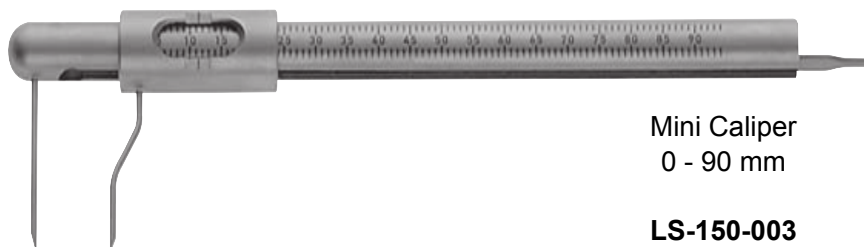

Mini Caliper  
0 - 90 mm

**LS-150-003**

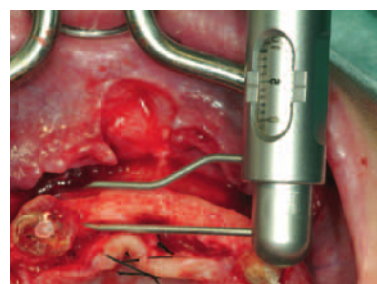
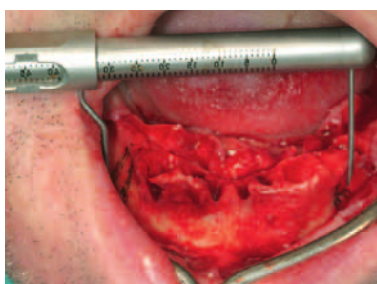

# Needle Holders with tungsten carbide inserts

Porta agujas con insertos de carburo tungsteno

## DERF

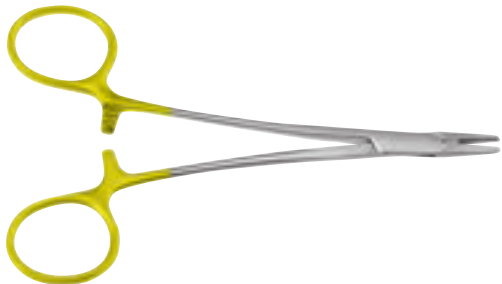

12,0 cm; 4 3/4"

051-010-12

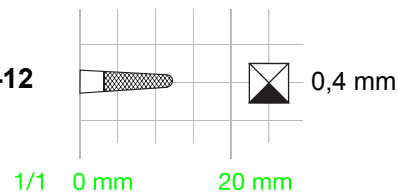

## CRILE-WOOD

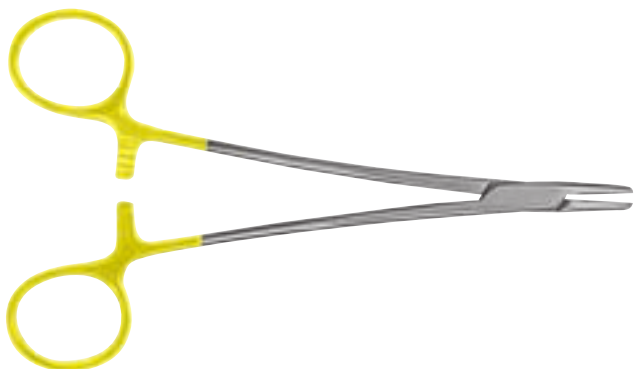

15,0 cm; 6"

051-060-15

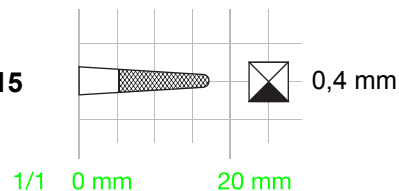

## OLSEN-HEGAR

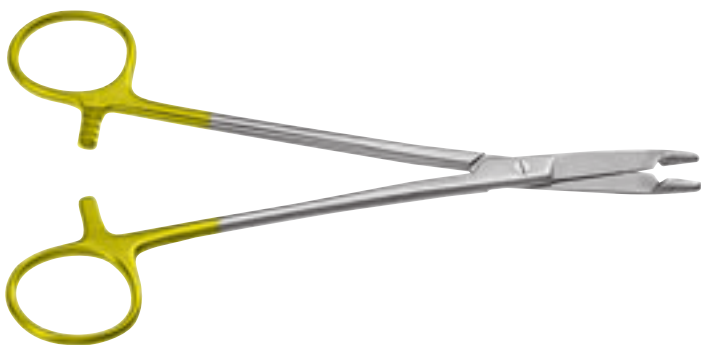

14,0 cm; 5 1/2"

051-310-14



17,0 cm; 6 3/4"

051-310-17

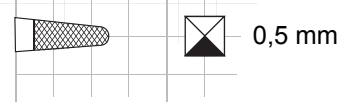

## MATHIEU



14,0 cm; 5 1/2"

051-350-14



17,0 cm; 6 3/4"

051-350-17

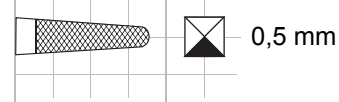



# Scalpels & more

## Bisturios y más

### Scalpel Handles

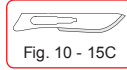

**003-003-01** No.3 with scale 13,0 cm; 5"



**003-010-16** No.3 14,5 cm; 5 3/4"



**003-011-16** No.3A 14,5 cm; 5 3/4"



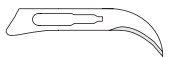

### Scalpel Blades (Box of 100)

**003-020-11** Fig. 11 

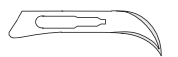
**003-020-12** Fig. 12 

**003-020-12D** Fig. 12D 

**003-020-15** Fig. 15 

**003-020-15C** Fig. 15C 

### Scalpel Blade Remover

**003-022-12** 12,5 cm; 5"

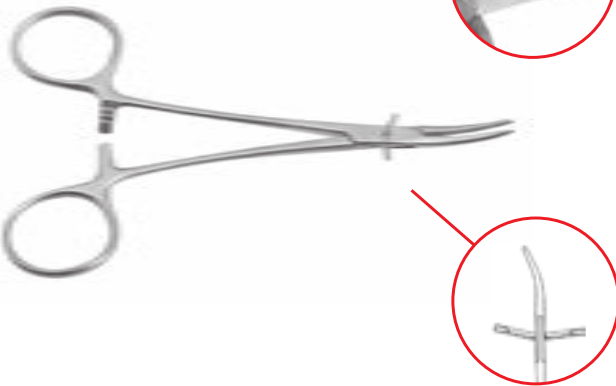

Ø 40,0 mm	<b>250-130-04</b>
Ø 60,0 mm	<b>250-130-06</b>
Ø 80,0 mm	<b>250-130-08</b>
Ø 100,0 mm	<b>250-130-10</b>
Ø 120,0 mm	<b>250-130-12</b>
Ø 150,0 mm	<b>250-130-15</b>

### Micro Scalpel Handles

**003-040-00** MICRO 13,5 cm; 5 1/4"



### Micro Scalpel Blades (Box of 10)

**003-040-64** Fig. 64 

**003-040-67** Fig. 67 

**003-040-69** Fig. 69 

# Dissecting & Ligature Scissors

Tijeras de disección y ligaduras

## BABY-METZENBAUM



11,5 cm; 4 1/2"

010-110-11

010-111-11

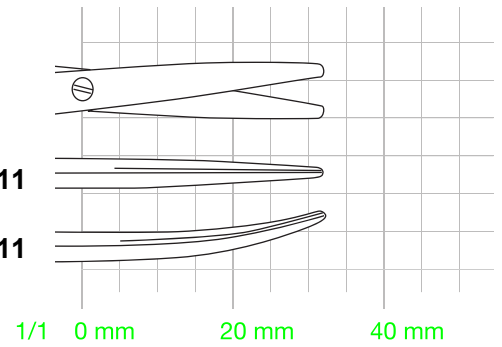

1/1 0 mm 20 mm 40 mm

## METZENBAUM



14,5 cm; 5 3/4"

010-110-14

010-111-14

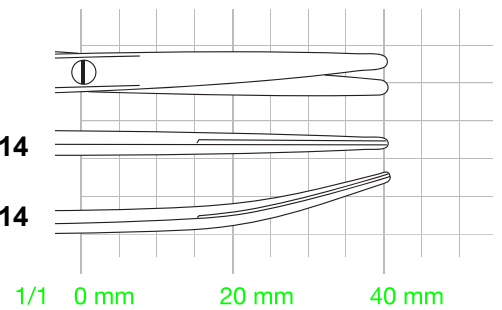

1/1 0 mm 20 mm 40 mm

## LITTAUER



11,5 cm; 4 1/2"

010-402-11

14,0 cm; 5 1/2"

010-402-14

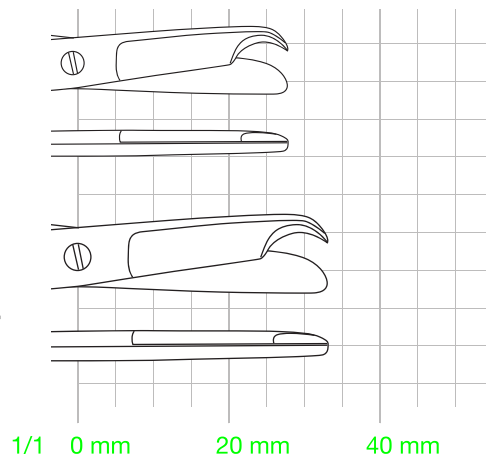

1/1 0 mm 20 mm 40 mm

## NORTHBENT



9,0 cm; 3 1/2"

010-411-09

13,0 cm; 5"

010-413-13

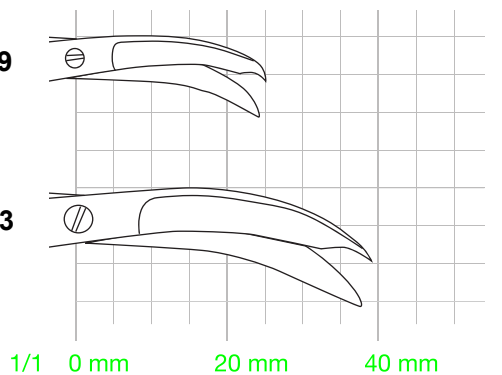

1/1 0 mm 20 mm 40 mm

# Fine Surgical Scissors

Tijeras quirúrgica fina

## IRIS



9,0 cm; 3 1/2"

**010-244-09**

9,0 cm; 3 1/2"

**010-245-09**

10,5 cm; 4 1/8"

**010-244-10**

10,5 cm; 4 1/8"

**010-245-10**

11,5 cm; 4 1/2"

**010-244-11**

11,5 cm; 4 1/2"

**010-245-11**

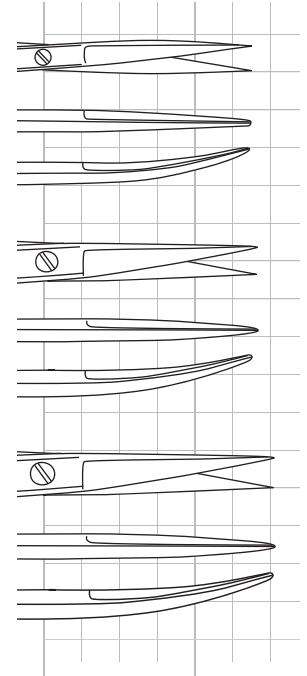

1/1 0 mm 20 mm



11,5 cm; 4 1/2"

**010-263-11**

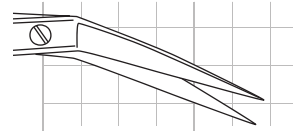

1/1 0 mm 20 mm

## LOCKLIN

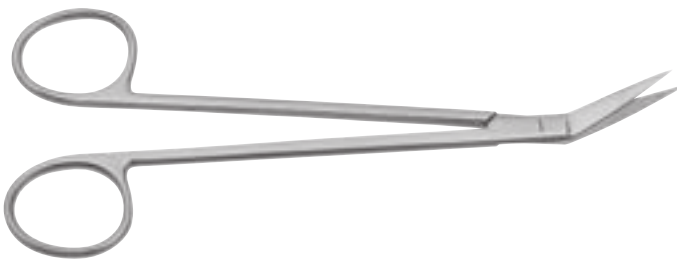

16,0 cm; 6 1/4"

**010-890-16**

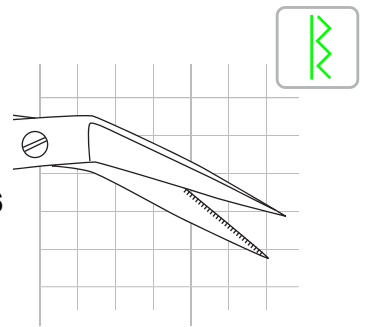

1/1 0 mm 20 mm

## LOCKLIN



16,0 cm; 6 1/4"

**010-891-16**

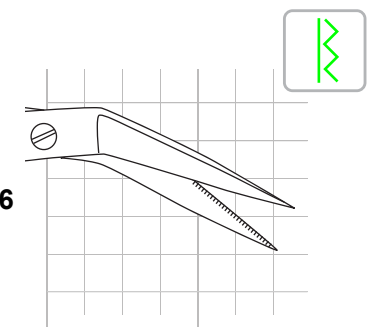

1/1 0 mm 20 mm

# Fine Surgical Scissors

## Tijeras quirúrgica fina

### GOLDMANN-FOX



13,0 cm; 5"

010-880-13

010-881-13

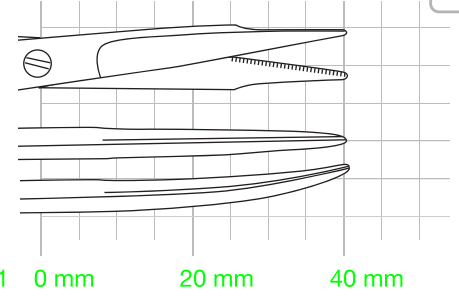

### LA GRANGE



11,5 cm; 4 1/2"

010-895-11

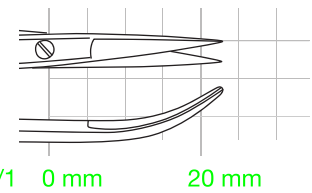

### KELLY



16,0 cm; 6 1/4"

010-634-16

010-635-16

18,0 cm; 7"

010-634-18

010-635-18

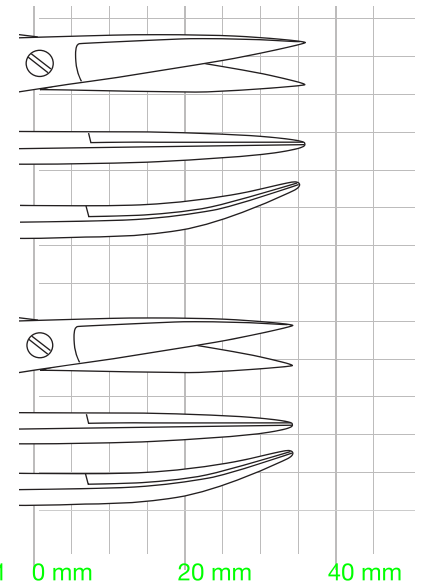

### DEAN



17,0 cm; 6 3/4"

010-893-17

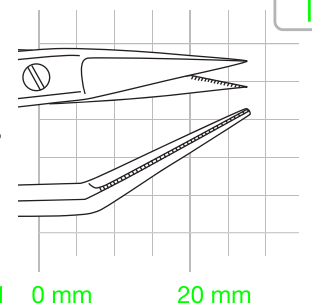



# Fine Surgical & Micro Scissors

Tijeras quirúrgica fina y micro

**BONN** very delicate



9,0 cm; 3 1/2"

sharp

**010-270-08**

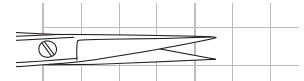

**010-271-08**



1/1 0 mm 20 mm

blunt

**010-270-09**

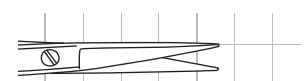

**010-271-09**

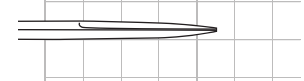

1/1 0 mm 20 mm

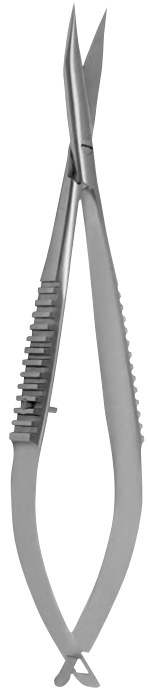

**018-081-11**  
sharp

**018-083-11**  
blunt



serrated



**GOMEL**

14,0 cm, **018-241-14Z**  
16,0 cm, **018-241-16Z**

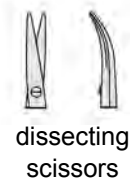

dissecting  
scissors



**HEPP SCHEIDEL**

14,0 cm, **018-243-14**  
16,0 cm, **018-243-16**

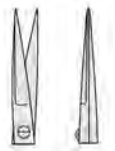

**018-246-01**

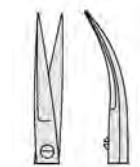

**018-246-02**



**018-246-03**

**WESTCOTT**

11,0 cm, 4 3/8"

18,5 cm, 7 1/4"

# Fine Surgical Scissors

## Tijeras quirúrgica fina

**IRIS Super Cut**



11,5 cm; 4 1/2"

012-244-11

012-245-11

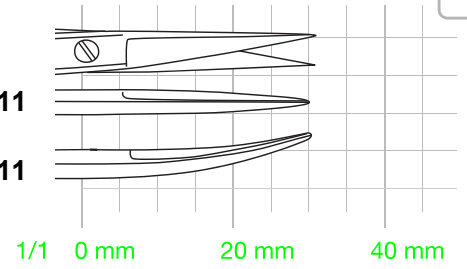

**LA GRANGE Super Cut**



11,5 cm; 4 1/2"

012-257-11

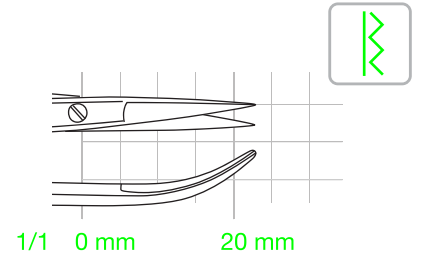

**GOLDMANN-FOX Super Cut**



13,0 cm; 5"

012-880-13

012-881-13

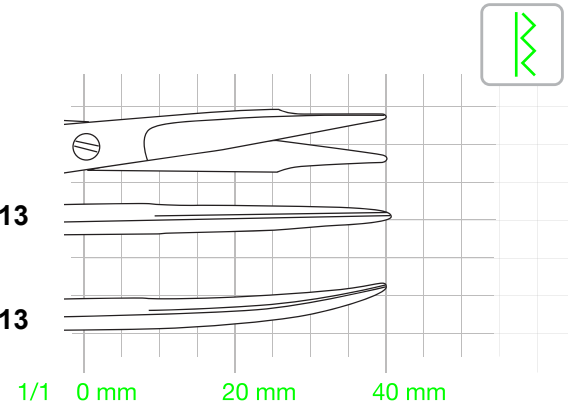

**IRIS Ceramic Coated**

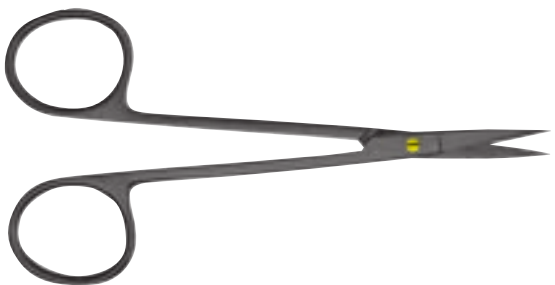

11,5 cm; 4 1/2"

014-244-11

014-245-11

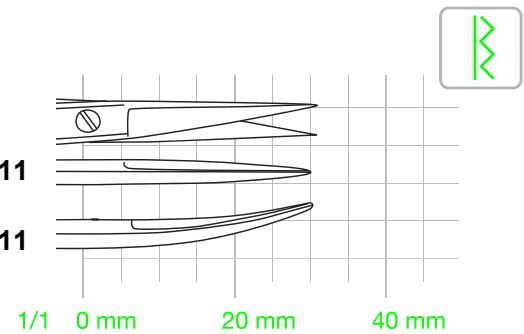

**LA GRANGE Ceramic Coated**

**SORRY,  
NO PHOTO  
AVAILABLE**

11,5 cm; 4 1/2"

014-257-11

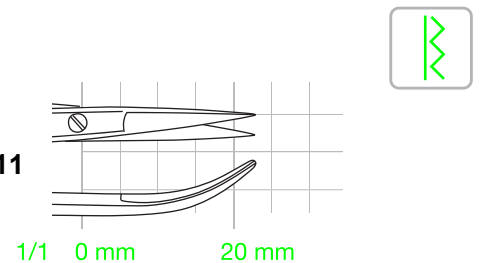

# Tissue Punches & Retractors

Tejido perforado y separadores



**SENN-MILLER**  
16,0 cm, 6 1/4"



**062-180-16**

sharp



**062-181-16**

blunt



flexible



16,0 cm, 6 1/4"



**062-088-02**

sharp



**062-088-03**

sharp



**062-088-04**

sharp



**062-089-02**

blunt



**062-089-03**

blunt



**062-089-04**

blunt



**RIBBON**  
malleable

- 200 x 6 mm **078-210-06**
- 200 x 12 mm **078-210-12**
- 200 x 17 mm **078-210-17**
- 200 x 20 mm **078-210-20**
- 200 x 25 mm **078-210-25**



**KEYES**  
12,0 cm, 4 3/4"

2 mm

**186-200-02**

3 mm

**186-200-03**

4 mm

**186-200-04**

5 mm

**186-200-05**

6 mm

**186-200-06**

7 mm

**186-200-07**

8 mm

**186-200-08**

# Towel Clamps & Haemostatic Forceps

Pinzas de campo y pinzas hemostáticas



**LORNA**



10,0 cm, 4"  
**030-014-10**

13,0 cm, 5 1/8"  
**030-014-13**



**BACKHAUS**

9,0 cm, 3 1/2" **030-000-09**  
 11,0 cm, 4 3/8" **030-000-11**  
 13,0 cm, 5 1/8" **030-000-13**  
 15,0 cm, 6" **030-000-15**



**HALSTED-MOSQUITO**

12,5 cm, 5" **040-050-12** **040-051-12**  
 14,0 cm, 5 1/2" **040-050-14** **040-051-14**

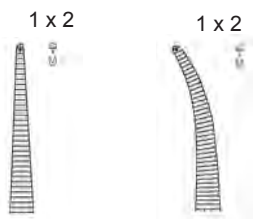
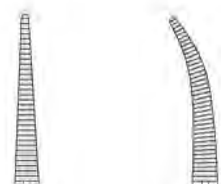

12,5 cm, 5" **040-070-12** **040-071-12**  
 14,0 cm, 5 1/2" **040-070-14** **040-071-14**



**KELLY**  
14,0 cm, 5 1/2"



**040-150-14**



**040-151-14**

# Suction Tubes & Syringes

Tubos de aspiración y jeringas

Charr. 6 **085-030-06**  
 Charr. 8 **085-030-08**  
 Charr. 10 **085-030-10**  
 Charr. 12 **085-030-12**

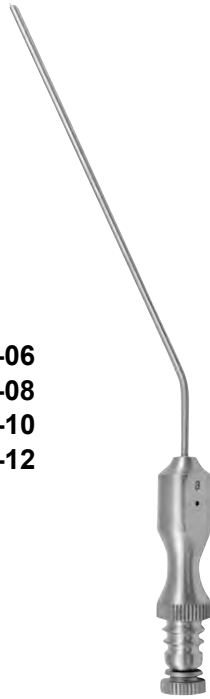

**FRAZIER**  
 19,0 cm; 7 1/2"

Charr. 6 **085-034-06**  
 Charr. 8 **085-034-08**  
 Charr. 10 **085-034-10**  
 Charr. 12 **085-034-12**

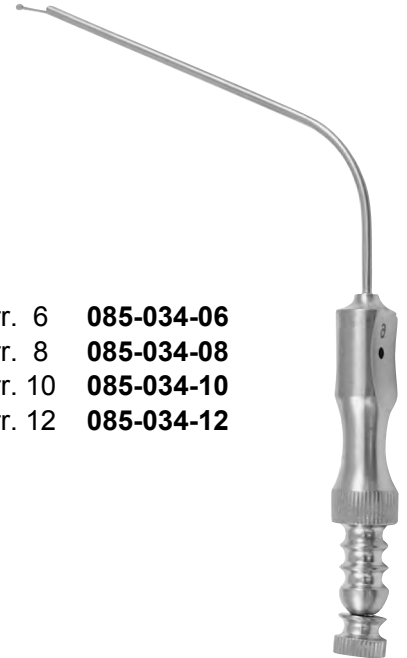

**POP PEN**  
 13,0 cm; 5"

  
 Ø 3,5 mm  
**085-010-35**



**YANKAUER**  
 27,0 cm; 10 5/8"  
**085-000-27**



Aspirating Cartridge  
 Syringe 1,8 cc

**LS-270-1US**

Charr. 6 **085-033-06**  
 Charr. 8 **085-033-08**  
 Charr. 10 **085-033-10**  
 Charr. 12 **085-033-12**



**FERGUSSON**  
 18,0 cm; 7"

# Atraumatic Forceps

## Pinzas atraumáticas

### DE BAKEY



16,0cm; 6 1/4"      20,0cm; 8"

020-700-16	020-700-20
020-702-16	020-702-20
020-704-16	020-704-20
020-706-16	020-706-20
020-708-16	020-708-20
020-716-16	020-716-20
020-718-16	020-718-20

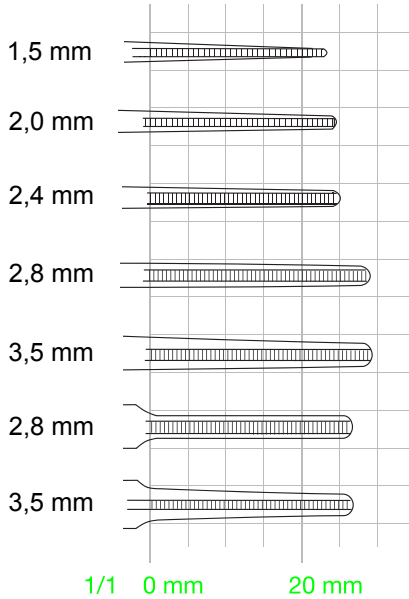

### DE BAKEY



16,0cm; 6 1/4"      20,0cm; 8"

020-701-16	020-701-20
020-703-16	020-703-20

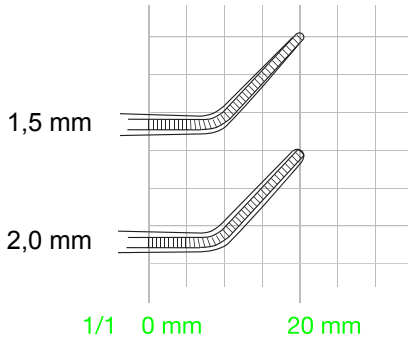



# Tissue Forceps

Pinzas quirúrgicas

## ADSON



12,0 cm; 4 3/4"

020-270-12

15,0 cm; 6"

020-270-15

 1x2

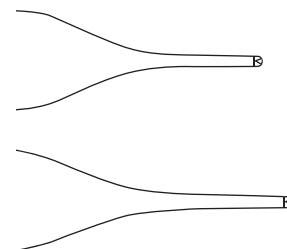

## MICRO-ADSON



12,0 cm; 4 3/4"

020-276-12

15,0 cm; 6"

020-276-15

 1x2

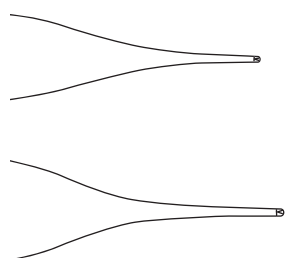

## ADSON



12,0 cm; 4 3/4"

020-282-12

1/1 0 mm

 1x2

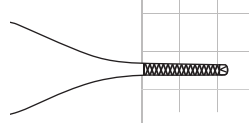

## ADSON-BROWN



12,0 cm; 4 3/4"

020-288-12

15,0 cm; 6"

020-288-15

 7x7

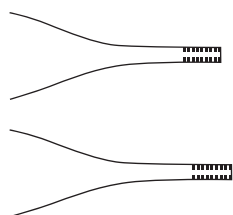

# Dressing Forceps

## Pinzas de disección

### ADSON



12,0 cm; 4 3/4"

020-070-12

15,0 cm; 6"

020-070-15

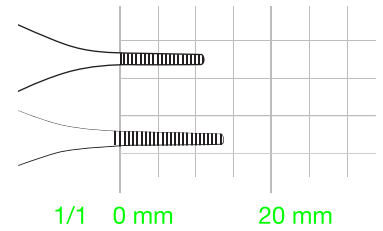

### MICRO-ADSON



12,0 cm; 4 3/4"

020-076-12

15,0 cm; 6"

020-076-15

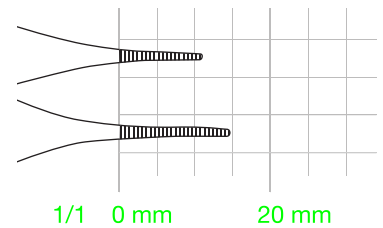

### ADSON cross serrated



12,0 cm; 4 3/4"

020-078-12

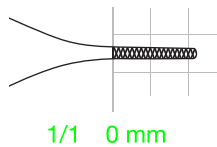

### GERALD



18,0 cm; 7"

020-102-18

020-103-18

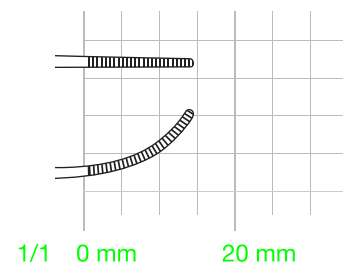

# Tissue Forceps & Forceps with tungsten carbide inserts

Pinzas quirúrgicas y Pinzas con insertos de carburo tungsteno

## GERALD



18,0 cm; 7"

020-302-18

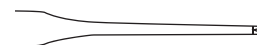

020-303-18



 1x2

## RUSS. MODELL



15,0 cm; 6"

020-456-15



20,0 cm; 8"

020-456-20



## ADSON



12,0 cm; 4 3/4"

021-070-12

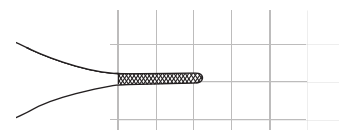

15,0 cm; 6"

021-070-15

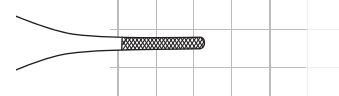

12,0 cm; 4 3/4"

021-270-12

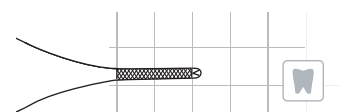

 1 x 2

15,0 cm; 6"

021-270-15

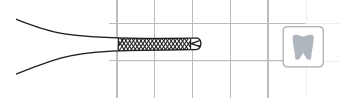

 1 x 2

1/1 0 mm 20 mm

## STANDARD



14,5 cm; 5 3/4"

021-200-14

16,0 cm; 6 1/4"

021-200-16

18,0 cm; 7"

021-200-18

20,0 cm; 8"

021-200-20



# Dressing Forceps

## Pinzas de disección

### STANDARD



13,0 cm; 5"

**020-002-13**

14,5 cm; 5 3/4"

**020-002-14**

16,0 cm; 6 1/4"

**020-002-16**

18,0 cm; 7"

**020-002-18**

20,0 cm; 8"

**020-002-20**

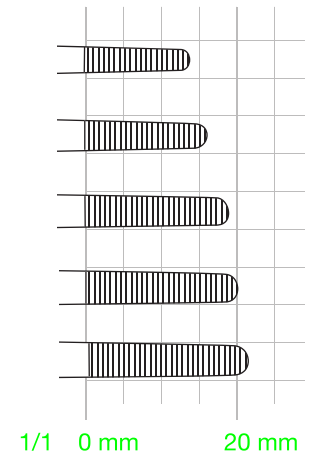

### STANDARD narrow



13,0 cm; 5"

**020-004-13**

14,5 cm; 5 3/4"

**020-004-14**

16,0 cm; 6 1/4"

**020-004-16**

18,0 cm; 7"

**020-004-18**

20,0 cm; 8"

**020-004-20**

