

Pinzetten
Forceps

020



Anatomische Pinzetten Dressing Forceps



Art.Nr. Beschreibung | Description Size Spez.

STANDARD



020-002-10		10,5cm; 4 1/8"	020-002-18		18,0cm; 7"
020-002-11		11,5cm; 4 1/2"	020-002-20		20,0cm; 8"
020-002-13		13,0cm; 5"	020-002-25		25,0cm; 10"
020-002-14		14,5cm; 5 3/4"	020-002-30		30,5cm; 12"
020-002-16		16,0cm; 6 1/4"			

1/1 0 mm 20 mm

STANDARD schmal | narrow



020-004-11		11,5cm; 4 1/2"	020-004-18		18,0cm; 7"
020-004-13		13,0cm; 5"	020-004-20		20,0cm; 8"
020-004-14		14,5cm; 5 3/4"	020-004-25		25,0cm; 10"
020-004-16		16,0cm; 6 1/4"	020-004-30		30,5cm; 12"

1/1 0 mm 20 mm

Anatomische Pinzetten Dressing Forceps

Art.Nr. Beschreibung | Description Size Spez.

STANDARD
fein | fine



020-010-10		10,5cm; 4 1/8"	020-010-18		18,0cm; 7"
020-010-11		11,5cm; 4 1/2"	020-010-20		20,0cm; 8"
020-010-13		13,0cm; 5"	020-010-25		25,0cm; 10"
020-010-14		14,5cm; 5 3/4"	020-010-30		30,5cm; 12"
020-010-16		16,0cm; 6 1/4"			

1/1 0 mm 20 mm

USA MODELL



020-006-12		12,0cm; 4 3/4"	020-006-18		18,0cm; 7"
020-006-13		13,0cm; 5"	020-006-20		20,0cm; 8"
020-006-14		14,5cm; 5 3/4"	020-006-25		25,0cm; 10"
020-006-15		15,0cm; 6"	020-006-30		30,5cm; 12"

1/1 0 mm 20 mm

Anatomische Pinzetten Dressing Forceps



Art.Nr.	Beschreibung Description	Size	Spez.
---------	----------------------------	------	-------

USA MODELL
schmal | narrow



020-012-12		12,0cm; 4 3/4"
020-012-14		14,5cm; 5 3/4"
020-012-15		15,0cm; 6"

1/1 0 mm 20 mm

020-008-15	STILLE	15,0cm; 6"
------------	--------	------------

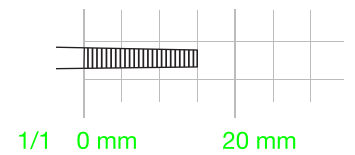

POTTS-SMITH



020-026-18		18,0cm; 7"
020-026-21		21,0cm; 8 1/4"
020-026-25		25,0cm; 10"
020-027-18		18,0cm; 7"
020-027-21		21,0cm; 8 1/4"
020-027-25		25,0cm; 10"

1/1 0 mm 20 mm

020

Anatomische Pinzetten Dressing Forceps

Art.Nr. Beschreibung | Description Size Spez.

SEMKEN



020-040-12

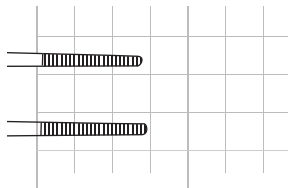

12,5cm; 5"

020-040-15

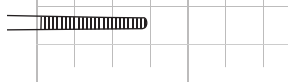

15,0cm; 6"

1/1 0 mm 20 mm

CUSHING

17,5cm; 6 7/8"



020-092-17

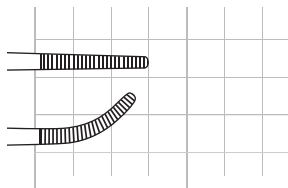

020-093-17

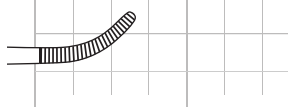

1/1 0 mm 20 mm

ADSON



020-070-12

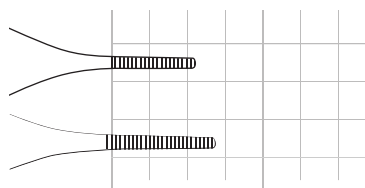

12,0cm; 4 3/4"

020-070-15



15,0cm; 6"

1/1 0 mm 20 mm

MICRO-ADSON



020-076-12

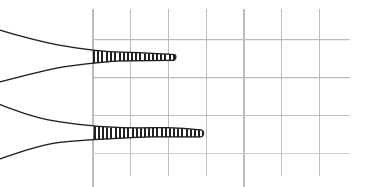

12,0cm; 4 3/4"

020-076-15

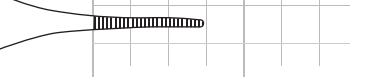

15,0cm; 6"

1/1 0 mm 20 mm

Anatomische Pinzetten Dressing Forceps



Art.Nr.	Beschreibung Description	Size	Spez.
020-078-12	ADSON kreuzgerieft cross serrated	12,0cm; 4 3/4"	

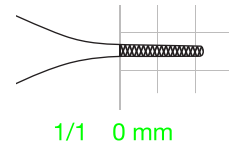

BROPHY

20,0cm; 8"



020-094-20

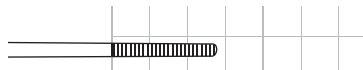

020-095-20

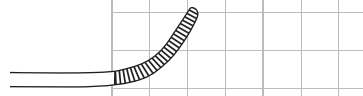

1/1 0 mm 20 mm

GERALD

18,0cm; 7"



020-102-18

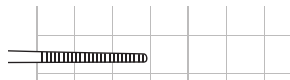

020-103-18



1/1 0 mm 20 mm

TAYLOR

17,5cm; 6 7/8"



020-114-17

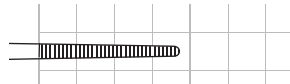



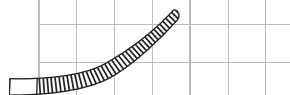





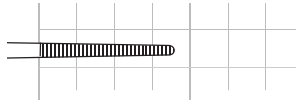

020-115-17

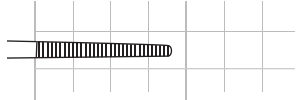

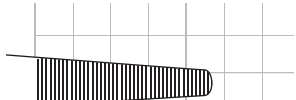
1/1 0 mm 20 mm

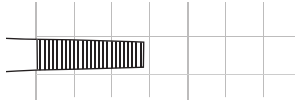
020

Anatomische Pinzetten Dressing Forceps

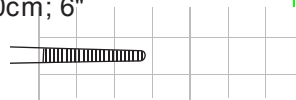
Art.Nr.	Beschreibung Description	Size	Spez.
020-116-17	TAYLOR mit Dissektorende with dissector end	17,0cm; 6 3/4"	
			1/1 0 mm 20 mm
020-117-18	TAYLOR mit Dissektorende with dissector end	18,5cm; 7 1/4"	
			1/1 0 mm 20 mm
020-120-18	BONNEY	18,0cm; 7"	
			1/1 0 mm 20 mm
020-136-18	RAMSEY	18,0cm; 7"	
			1/1 0 mm 20 mm
	WAUGH		
			
020-130-15		15,0cm; 6"	
			
020-130-20		20,0cm; 8"	
			
020-158-15	MC INDOE	15,0cm; 6"	
			1/1 0 mm 20 mm

Chirurgische Pinzetten Tissue Forceps











Art.Nr. Beschreibung | Description Size Spez.

STANDARD

 1x2



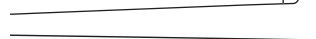



020-200-10		10,5cm; 4 1/8"
020-200-11		11,5cm; 4 1/2"
020-200-13		13,0cm; 5"
020-200-14		14,5cm; 5 3/4"
020-200-15		15,0cm; 6"
020-200-16		16,0cm; 6 1/4"
020-200-18		18,0cm; 7"
020-200-20		20,0cm; 8"
020-200-25		25,0cm; 10"
020-200-30		30,5cm; 12"

STANDARD fein | fine

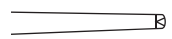
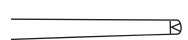
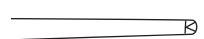
 1x2



020-210-13		13,0cm; 5"
020-210-14		14,5cm; 5 3/4"
020-210-16		16,0cm; 6 1/4"
020-210-18		18,0cm; 7"
020-210-20		20,0cm; 8"
020-210-25		25,0cm; 10"









Chirurgische Pinzetten Tissue Forceps

Art.Nr.	Beschreibung Description	Size	Spez.
---------	----------------------------	------	-------

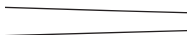
USA MODELL

 1x2







020-206-12		12,0cm; 4 3/4"
020-206-13		13,0cm; 5"
020-206-14		14,5cm; 5 3/4"
020-206-15		15,0cm; 6"
020-206-18		18,0cm; 7"
020-206-20		20,0cm; 8"
020-206-25		25,0cm; 10"
020-206-30		25,0cm; 10"

STILLE

15,0cm; 6"



020-208-15		 1x2
020-209-15		 2x3

020-240-15	SEMKEN	15,0cm; 6"	 1x2
------------	--------	------------	-------------------------------------------------------------------------------------------



Chirurgische Pinzetten
Tissue Forceps





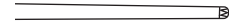

Art.Nr.	Beschreibung Description	Size	Spez.
020-242-12	SEMKEN	12,5cm; 5"	 2x3

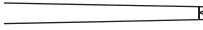

POTTS-SMITH

 1x2

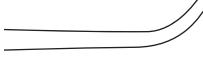

020-226-18		18,0cm; 7"
020-226-21		21,0cm; 8 1/4"
020-226-25		25,0cm; 10"
020-227-18		18,0cm; 7"
020-227-21		21,0cm; 8 1/4"
020-227-25		25,0cm; 10"







Chirurgische Pinzetten Tissue Forceps

Art.Nr.	Beschreibung Description	Size	Spez.
---------	----------------------------	------	-------

STANDARD

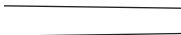
 2x3



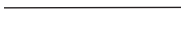
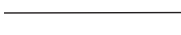

020-252-11		11,5cm; 4 1/2"
020-252-13		13,0cm; 5"
020-252-14		14,5cm; 5 3/4"
020-252-16		16,0cm; 6 1/4"
020-252-18		18,0cm; 7"
020-252-20		20,0cm; 8"
020-252-25		25,0cm; 10"
020-252-30		30,0cm; 12"

STANDARD

 3x4

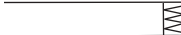



020-254-14		14,5cm; 5 3/4"
020-254-16		16,0cm; 6 1/4"

STANDARD

 4x5



020-256-14		14,5cm; 5 3/4"
020-256-16		16,0cm; 6 1/4"

Chirurgische Pinzetten
Tissue Forceps



Art.Nr. Beschreibung | Description Size Spez.

ADSON

 1x2



020-270-12

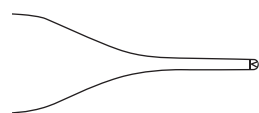

12,0cm; 4 3/4"

020-270-15

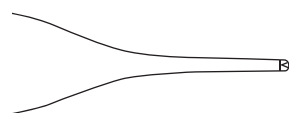

15,0cm; 6"

MICRO-ADSON

 1x2



020-276-12

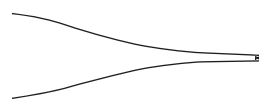

12,0cm; 4 3/4"

020-276-15

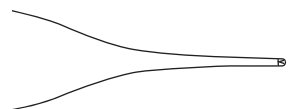

15,0cm; 6"

020-282-12

ADSON

12,0cm; 4 3/4"

 1x2

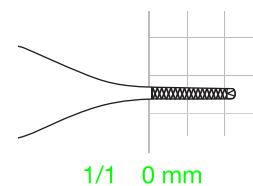

ADSON-BROWN

  7x7



020-288-12

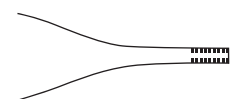

12,0cm; 4 3/4"

020-288-15

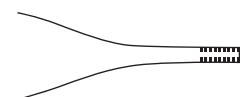

15,0cm; 6"

020

Chirurgische Pinzetten Tissue Forceps

Art.Nr.	Beschreibung Description	Size	Spez.
---------	----------------------------	------	-------

CUSHING

17,5cm; 6 7/8"



1x2



020-292-17

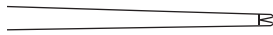

020-293-17



GERALD

18,0cm; 7"



1x2



020-302-18



020-303-18



020-300-15

GILLIES

15,0cm; 6"



1x2

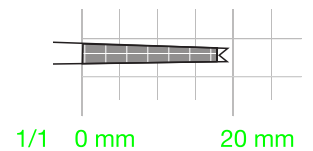

1/1 0 mm

20 mm

020-308-18

STILLE - BARRAYA

18,0cm; 7"



3x4

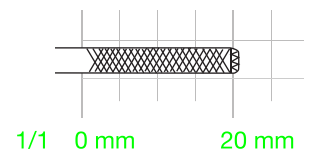

1/1 0 mm

20 mm

020

Chirurgische Pinzetten Tissue Forceps



Art.Nr.	Beschreibung Description	Size	Spez.
020-330-20	WAUGH	20,0cm; 8"	 1x2

kreuzgerieft | cross serrated

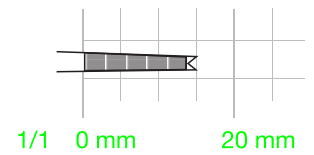

020-314-17	TAYLOR	17,5cm; 6 7/8"	 1x2
------------	--------	----------------	-----------------------------------------------------------------------------------------



020-316-17	TAYLOR	17,0cm; 6 3/4"	 1x2
------------	--------	----------------	-------------------------------------------------------------------------------------------

mit Dissektorende | with dissector end

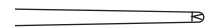

020-317-17	TAYLOR	17,5cm; 6 7/8"	 1x2
------------	--------	----------------	-------------------------------------------------------------------------------------------

mit Dissektorende | with dissector end

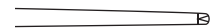

020

Chirurgische Pinzetten Tissue Forceps

Art.Nr.	Beschreibung Description	Size	Spez.
---------	----------------------------	------	-------

020-376-15	STONE	15,0cm; 6"	 4x5
------------	-------	------------	-----------------------------------------------------------------------------------------

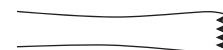

020-378-15	LERCHE	15,0cm; 6"	 5x6
------------	--------	------------	-----------------------------------------------------------------------------------------



	ADLERKREUTZ		 2x3
--	-------------	--	-------------------------------------------------------------------------------------------



020-382-15		15,0cm; 6"
------------	-------------------------------------------------------------------------------------	------------

020-382-20		20,0cm; 8"
------------	-------------------------------------------------------------------------------------	------------

1/1 0 mm 20 mm

	ADLERKREUTZ		 4x5
--	-------------	--	-------------------------------------------------------------------------------------------



020-384-15		15,0cm; 6"
------------	-------------------------------------------------------------------------------------	------------

020-384-20		20,0cm; 8"
------------	-------------------------------------------------------------------------------------	------------

020-384-25		20,0cm; 8"
------------	-------------------------------------------------------------------------------------	------------

1/1 0 mm 20 mm

Chirurgische Pinzetten Tissue Forceps



Art.Nr.	Beschreibung Description	Size	Spez.
---------	----------------------------	------	-------

RUSS. MODELL



020-456-15		15,0cm; 6"
------------	-----------------------------------------------------------------------------------	------------

020-456-20		20,0cm; 8"
------------	-----------------------------------------------------------------------------------	------------

020-456-25		25,0cm; 10"
------------	-----------------------------------------------------------------------------------	-------------

020-590-18	BONNEY	18,0cm; 7"	 1x2
------------	--------	------------	-----------------------------------------------------------------------------------------

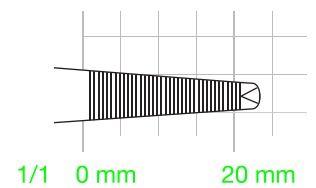

DURANTE



020-460-14		14,5cm; 5 3/4"
------------	-------------------------------------------------------------------------------------	----------------

020-460-16		16,0cm; 6 1/4"
------------	-------------------------------------------------------------------------------------	----------------

020-460-20		20,0cm; 8"
------------	-------------------------------------------------------------------------------------	------------

020-514-23	MAYO	23,0cm; 9"
------------	------	------------



020

Chirurgische Pinzetten
Tissue Forceps

Art.Nr.	Beschreibung Description	Size	Spez.
---------	----------------------------	------	-------

SINGLEY-TUTTLE



020-516-18



18,0cm; 7"

020-516-23

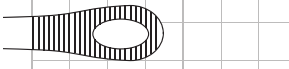

23,0cm; 9"

1/1 0 mm 20 mm

NELSON



020-518-15

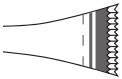

15,0cm; 6"

020-518-23

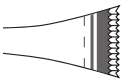

23,0cm; 9"

Uhrmacher Pinzetten
Jeweller Type Forceps



Art.Nr.	Beschreibung Description	Size	Spez.
020-601-03	FIG. 3	11,5cm; 4 1/2"	
020-601-13	FIG. 3C	11,0cm; 4 1/4"	
020-601-04	FIG. 4	11,5cm; 4 1/2"	
020-601-05	FIG. 5	11,5cm; 4 1/2"	
020-601-07	FIG. 7	11,5cm; 4 1/2"	

Splinterpinzetten
Splinter Forceps

Art.Nr.	Beschreibung Description	Size	Spez.
---------	----------------------------	------	-------

FEILCHENFELD



020-650-07



7,5cm; 3 1/8"

020-650-09



9,0cm; 3 1/2"

020-650-11



11,5cm; 4 1/2"

1/1 0 mm 20 mm

HUNTER

10,5cm; 4 1/4"



020-652-10

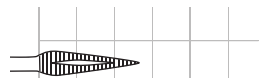

020-653-10



1/1 0 mm 20 mm

glattes Maul | smooth jaw

12,5cm; 5"



020-660-12



020-661-12



1/1 0 mm 20 mm

Splitterpinzetten Splinter Forceps



Art.Nr.	Beschreibung Description	Size	Spez.
	gerieftes Maul serrated jaw	12,5cm; 5"	

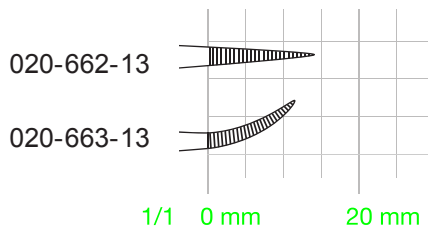

ohne Stift | without pin

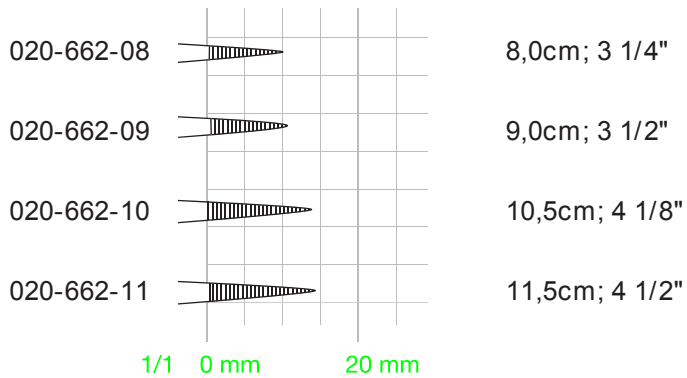

mit Stift | with pin

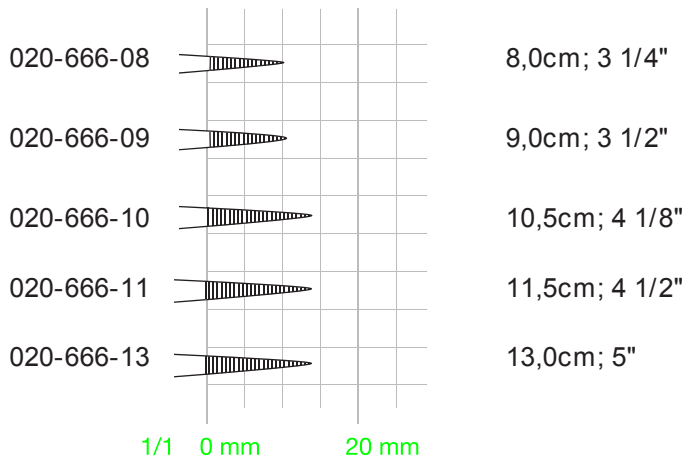

020

Splitterpinzetten
Splinter Forceps

Art.Nr.	Beschreibung Description	Size	Spez.
---------	----------------------------	------	-------

STIEGLITZ

13,5cm; 5 1/4"



020-670-13

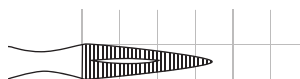

020-671-13

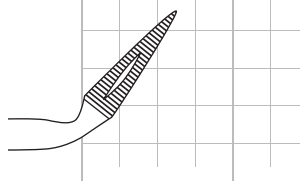

1/1 0 mm 20 mm

020-680-11

PEET

12,5cm; 5"

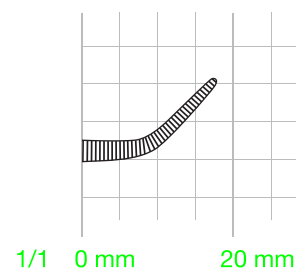

1/1 0 mm 20 mm

Splitterpinzetten
Splinter Forceps



Art.Nr.	Beschreibung Description	Size	Spez.
	RALK	15,0cm; 6"	

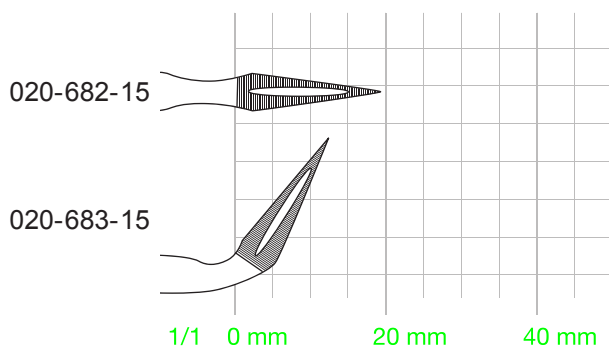

Atraumatische Pinzetten
Atraumatic Dressing Forceps

Art.Nr. Beschreibung | Description Size Spez.

DE BAKEY

ATRAUMA



16,0cm; 6 1/4" 20,0cm; 8" 24,0cm; 9 1/2" 30,0cm; 12"

1,5 mm	020-700-16	020-700-20	020-700-24	020-700-30
2,0 mm	020-702-16	020-702-20	020-702-24	020-702-30
2,4 mm	020-704-16	020-704-20	020-704-24	020-704-30
2,8 mm	020-706-16	020-706-20	020-706-24	020-706-30
3,5 mm	020-708-16	020-708-20	020-708-24	020-708-30
2,8 mm	020-716-16	020-716-20	020-716-24	020-716-30
3,5 mm	020-718-16	020-718-20	020-718-24	020-718-30

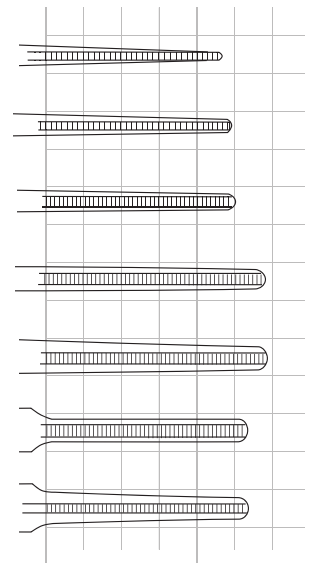

1/1 0 mm 20 mm

DE BAKEY

ATRAUMA



16,0cm; 6 1/4" 20,0cm; 8" 24,0cm; 9 1/2" 30,0cm; 12"

1,5 mm	020-701-16	020-701-20	020-701-24	020-701-30
2,0 mm	020-703-16	020-703-20	020-703-24	020-703-30

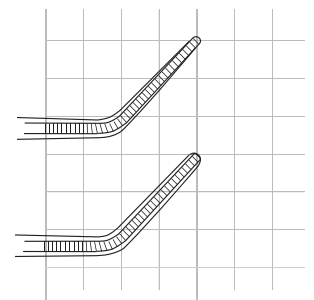

1/1 0 mm 20 mm

Cilienpinzetten
Cilia Forceps



Art.Nr.	Beschreibung Description	Size	Spez.
020-733-10	BARRAQUER	10,5cm; 4 1/8"	



020-740-08	LITTAUER	9,0cm; 3 1/2"	
------------	----------	---------------	--











020-744-09	DOUGLAS	9,0cm; 3 1/2"	
------------	---------	---------------	--

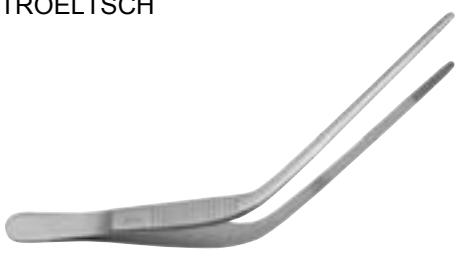
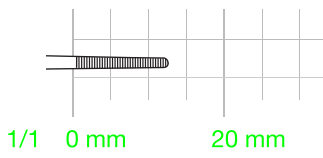

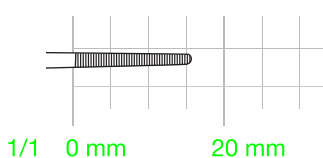
020-746-09	BEER	9,0cm; 3 1/2"	
------------	------	---------------	--

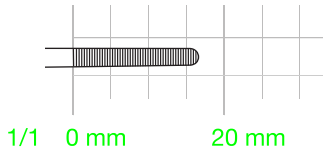

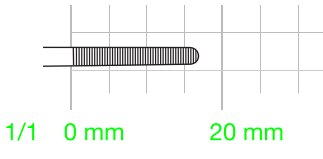
Ohrpinzetten Ear Forceps

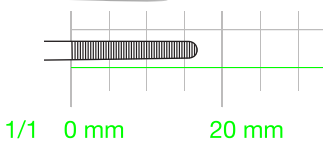
Art.Nr.	Beschreibung Description	Size	Spez.
020-750-11	TROELTSCH 	10,5cm; 4 1/8"	
020-750-13	TROELTSCH 	12,5cm; 5"	
020-750-15	TROELTSCH 	15,0cm; 6"	
020-756-14	GRÜNWALD 	14,5cm; 5 3/4"	
020-790-20	GRÜNWALD 	20,0cm; 8"	

Mikropinzetten, Iris Pinzetten
Micro Forceps, Iris Forceps



Art.Nr.	Beschreibung Description	Size	Spez.
---------	----------------------------	------	-------

JANSEN



020-760-16		16,0cm; 6 1/4"
020-760-20		21,5cm; 8 1/2"
020-760-22		22,0cm; 8 3/4"

1/1 0 mm 20 mm

fein | fine

10,0cm; 4"



020-810-10	
020-811-10	
020-813-10	

1/1 0 mm 20 mm

020-814-10 1x2

020-815-10 1x2

020-817-10 1x2

020

Mikropinzetten, Iris Pinzetten
 Micro Forceps, Iris Forceps

Art.Nr.	Beschreibung Description	Size	Spez.
		15,5cm; 6"	



020-096-06		0,6 mm
020-096-08		0,8 mm
020-096-10		1,0 mm

1/1 0 mm 20 mm

020-296-06		0,6 mm	1x2
020-296-08		0,8 mm	
020-296-10		1,0 mm	

Weitere Artikel
further items



Art.Nr.	Beschreibung Description	Size	Spez.
Other items available but not illustrated			
020-002-15	STANDARD dressing forceps; straight; serrated	15,0cm; 6"	
	STANDARD dressing forceps; curved; serrated; narrow		
020-003-10		10,5cm; 4,2"	
020-003-11		11,5cm ; 4,6"	
020-003-13		13,0cm; 5,2"	
020-003-14		14,5cm; 5,8"	
020-003-16		16,0cm; 6,4"	
020-003-18		18,0cm; 7,2"	
020-003-20		20,0cm; 8"	
020-003-25		25,0cm; 10"	
020-003-30		30,0cm; 12"	
	STANDARD dressing forceps; straight; serrated; narrow		
020-004-10		10,5cm; 4,2"	
020-004-35		35,0cm; 12"	
	STILLE dressing forceps; straight; serrated		
020-008-11		11,5cm; 4,6"	
020-008-13		13,0cm; 5,2"	
020-008-17		17,0cm; 6,8"	
	STANDARD dressing forceps; curved; serrated; fine		
020-011-10		10,5cm; 4,2"	
020-011-11		11,5cm; 4,6"	
020-011-13		13,0cm; 5,2"	
020-011-14		14,5cm; 5,8"	
020-011-16		16,0cm; 6,4"	
020-011-18		18,0cm; 7,2"	
020-011-20		20,0cm; 8"	
020-011-25		25,0cm; 10"	
020-011-30		30,0cm; 12"	
	MODELL USA dressing forceps; straight; serrated; narrow		
020-012-13		13,0cm; 5,2"	
020-012-18		18,0cm; 7,2"	
020-012-20		20,0cm; 8"	
020-021-10	Forceps; strongly curved; fine	10,5cm 4,2"	
	SEMKEN dressing forceps; curved; serrated		
020-041-12		12,5cm; 5"	
020-041-15		15,0cm; 6"	
020-060-12	EWALD dressing forceps; straight; serrated	12,0cm; 4,8"	
020-072-12	JACOBSON dressing forceps; straight; serrated	12,0cm; 4,8"	

Weitere Artikel
further items

Art.Nr.	Beschreibung Description	Size	Spez.
Other items available but not illustrated			
020-105-18	GERALD dressing forceps; bayonett shaped; serrated	18,0cm; 7,2"	
020-140-23	WANGENSTEEN dressing forceps; straight; cross serrated	23,0cm; 9,2"	
	STANDARD tissue forceps; straight; 1X2 teeth; narrow		
020-202-10		10,5cm; 4,2"	
020-202-11		11,5cm; 4,6"	
020-202-13		13,0cm; 5,2"	
020-202-14		14,5cm; 5,8"	
020-202-16		16,0cm; 6,4"	
020-202-18		18,0cm; 7,2"	
020-202-20		20,0cm; 8"	
020-202-25		25,0cm; 10"	
020-202-30		30,0cm; 12"	
	MODELL USA tissue forceps; straight; 2X3 teeth		
020-212-12		12,0cm; 4,8"	
020-212-13		13,0cm; 5,2"	
020-212-14		14,5cm; 5,8"	
020-212-15		15,0cm; 6"	
020-212-18		18,0cm; 7,2"	
020-212-20		21,0cm; 8,4"	
020-212-25		25,0cm; 10"	
020-212-30		30,0cm; 12"	
	MODELL USA tissue forceps; straight; 1X2 teeth; narrow		
020-214-13		13,0cm; 5,2"	
020-214-14		14,5cm; 5,8"	
020-214-15		15,5cm; 6,2"	
	STANDARD tissue forceps; curved; 1X2 teeth; without pin!		
020-219-13		13,0cm; 5,2"	
020-219-14		14,5cm; 5,8"	
020-219-16		16,0cm; 6,4"	
020-219-18		18,0cm; 7,2"	
020-219-20		20,0cm; 8"	
020-221-10	STANDARD tissue forceps; strong curved; 1X2 teeth	10,5cm; 4,2"	
020-240-12	SEMKEN tissue forceps; straight; 1X2 teeth	12,5cm; 5"	
	SEMKEN tissue forceps; curved; 1X2 teeth		
020-241-12		12,5cm; 5"	
020-241-15		15,5cm; 6,2"	
	STANDARD tissue forceps; straight; 3X4 teeth		
020-254-13		13,0cm; 5,2"	
020-254-18		18,0cm; 7"	
020-254-20		20,0cm; 8"	

Weitere Artikel
further items



Art.Nr.	Beschreibung Description	Size	Spez.
Other items available but not illustrated			
020-256-13	STANDARD tissue forceps; straight; 4X5 teeth	13,0cm; 5,2"	
020-260-12	EWALD tissue forceps; straight; 1X2 teeth	12,0cm; 4,8"	
020-274-12	ADSON tissue forceps; straight; 2X3 teeth	12,0cm; 4,8"	
020-274-15		15,0cm; 6"	
020-277-15	MICRO-ADSON tissue forceps; angled; 1X2 teeth	15,0cm; 6"	
020-278-12	ADSON tissue forceps; straight; 1X2 teeth; cross serrated	12,0cm; 4,8"	
020-279-12	MICRO-ADSON tissue forceps; angled; 1X2 teeth; cross serrated	12,0cm; 4,8"	
020-289-18	JEFFERSON tissue forcpeps; straight; 1X2 teeth	18,0cm; 7,2"	
020-290-18	CHUSING tissue forceps; straight; 1X2 teeth; dissector end	18,0cm; 7,2"	
020-294-20	BROPHY tissue forceps straight; 1X2 teeth	20,0cm; 8"	
020-295-20			curved; 1X2 teeth
020-308-20	STILLE-BARRAYA tissue forceps; straight; 3X4 teeth; cross serrated	20,0cm; 8"	
020-308-25		25,0cm; 10"	
020-315-17	TAYLOR tissue forceps; curved; 1X2 teeth	17,5cm; 7"	
020-330-15	WAUGH tissue forceps; straight; 1X2 teeth; serrated	15,0cm; 6"	
020-330-18		18,0cm; 7"	
020-358-15	MC INDOE tissue forceps; straight; 1X2 teeth; serrated	15,0cm 6"	
020-410-15	BROWN tissue forceps; straight; 7X7 teeth	15,0cm; 6"	
020-410-20		20,0cm; 8"	
020-410-25		25,0cm; 10"	
020-412-12	ADSON-BROWN tissue forceps; straight; 9X9 teeth	12,0cm; 4,8"	
020-412-15		15,0cm; 6"	
020-420-14	LANE tissue forceps; straight; 1X2 teeth	14,5cm; 5,8"	
020-420-20		20,0cm; 8"	

Weitere Artikel
further items

Art.Nr.	Beschreibung Description	Size	Spez.
Other items available but not illustrated			
020-422-14 020-422-20	LANE tissue forceps; straight; 2X3 teeth	14,5cm; 5,8" 20,0cm; 8"	
020-426-18	FERRIS-SMITH tissue forceps; straight; 2X3 teeth	18,0cm; 7,2"	
020-470-20	DUEHRSEN dressing forceps; straight; serrated	20,0cm; 8"	
020-494-01 020-494-02 020-494-03	COLLIN-DUVAL grasping forceps straight; figure 1; 14mm straight; figure 2; 18mm straight; figure 3; 27mm	20,0cm; 8"	
020-510-13 020-510-15	TREVES tissue forceps; straight; 2X3 teeth	13,0cm; 5,2" 15,0cm; 6"	
020-516-28	SINGLEY-TUTTLE grasping forceps; straight	28,0cm; 11,2"	
020-518-18	NELSON grasping forceps; straight	18,0cm; 7,2"	
020-520-18	RAMSEY tissue forceps; straight	18,0cm; 7,2"	
020-525-15	FOX forceps; curved	15,0cm; 6"	
020-586-14 020-587-14	DUVAL intestinal forceps straight; figure 1 straight; figure 2	14,0cm; 5,6"	
020-592-18	BONNEY tissue forceps; straight; 2X3 teeth	18,0cm; 7,2"	
020-601-01 020-601-02	JEWELLER TYPE forceps straight; figure 1 straight; figure 2	12,0cm; 4,8"	
020-601-15	JEWELLER TYPE forceps; angled; figure 5A	11,0cm; 4,4"	
020-601-45	JEWELLER TYPE forceps; 45° curved; figure 5	10,5cm; 4,2"	
020-601-90	JEWELLER TYPE forceps; 90° curved; figure 5	10,5cm; 4,2"	
020-602-07	JEWELLER TYPE forceps; curved; figure 7	11,5cm; 4,6"	
020-620-01 020-620-02 020-620-03 020-620-04	Vessel Dilator 45° angled; 0,3mm 90° angled; 0,3mm straight; 0,3mm 45° angled; 0,3mm; diamond dust	11,0cm; 4,4"	

Weitere Artikel
further items



Art.Nr.	Beschreibung Description	Size	Spez.
Other items available but not illustrated			
020-630-09	Tying forceps; straight; 1X2 teeth	9,5cm; 3,8"	
020-634-12 020-634-13	Vessel Dilator; straight; 0,3mm; blunt	12,0cm; 4,8" 13,5cm; 5,4"	
020-635-13	Vessel Dilator; curved; 0,4mm	11,5cm; 5,4"	
020-637-13	Vessel Dilator; 45° angled; 0,3mm	13,5cm; 5,4"	
020-656-10 020-657-10	WALTER-CARMALT splinter forceps straight curved	10,5cm; 4,2"	
020-660-08 020-660-09 020-660-10 020-660-11 020-660-14	splinter forceps; straight; smooth; without Pin	8,0cm; 3,2" 9,0cm; 3,6" 10,5cm; 4,2" 11,5cm; 4,6" 14,5cm; 5,8"	
020-661-08 020-661-09 020-661-10 020-661-11 020-661-14	splinter forceps; curved; smooth; without Pin	8,0cm; 3,2" 9,0cm; 3,6" 10,5cm; 4,2" 11,5cm; 4,6" 14,5cm; 5,8"	
020-662-14	splinter forceps; straight; serrated; without Pin	14,5cm; 5,8"	
020-663-08 020-663-09 020-663-10 020-663-11 020-663-14	splinter forceps; curved; serrated; without Pin	8,0cm; 3,2" 9,0cm; 3,6" 10,5cm; 4,2" 11,5cm; 4,6" 14,5cm; 5,8"	
020-664-08 020-664-09 020-664-10 020-664-11 020-664-12 020-664-14	splinter forceps; straight; smooth; with Pin	8,0cm; 3,2" 9,0cm; 3,6" 10,5cm; 4,2" 11,5cm; 4,6" 12,5cm; 5" 14,5cm; 5,8"	
020-665-08 020-665-09 020-665-10 020-665-11 020-665-12 020-665-14	splinter forceps; curved; smooth; with Pin	8,0cm; 3,2" 9,0cm; 3,6" 10,5cm; 4,2" 11,5cm; 4,6" 12,5cm; 5" 14,5cm; 5,8"	

020

Weitere Artikel
further items

Art.Nr.	Beschreibung Description	Size	Spez.
Other items available but not illustrated			
020-666-14	splinter forceps; straight; serrated; with Pin	14,5cm; 5,8"	
	splinter forceps; curved; serrated; with Pin		
020-667-08		8,0cm; 3,2"	
020-667-09		9,0cm; 3,6"	
020-667-10		10,5cm; 4,2"	
020-667-11		11,5cm; 4,6"	
020-667-13		13,0cm; 5,2"	
020-667-14		14,5cm; 5,8"	
020-671-90	STIEGLITZ splinter forceps 90° curved; with lock	13,5cm; 5,4"	
020-672-13	straight; without lock		
020-673-13	STIEGLITZ splinter forceps; curved; without lock	13,5cm; 5,4"	
	DE BAKEY vascular forceps; straight; atraumatic; Ø 1,0mm		
020-698-16		16,0cm; 6,4"	
020-698-20		20,0cm; 8"	
020-698-24		24,0cm; 9,6"	
	DE BAKEY vascular forceps TITAN; straight; atraumatic; Ø 1,5mm		
020-700-15T		15,0cm	
020-700-20T		20,0cm; 8"	
020-700-24T		24,0cm	
	DE BAKEY vascular forceps TITAN; straight; atraumatic; Ø 2,0mm		
020-702-15T		15,0cm	
020-702-20T		20,0cm	
020-702-24T		24,0cm	
	DE BAKEY vascular forceps straight; atraumatic; Ø 2mm	36,0cm; 14,4"	
020-702-36	straight; atraumatic; Ø 2mm		
020-706-36	straight; atraumatic; Ø 2,8mm		
	DE BAKEY vascular forceps; straight; atraumatic; Ø 3,5mm		
020-708-35		35,0cm; 14"	
020-708-36		36,0cm; 14,4"	
	DE BAKEY vascular forceps straight; atraumatic; Ø 2,8mm	36,0cm; 14,4"	
020-716-36	straight; atraumatic; Ø 2,8mm		
020-718-36	straight; atraumatic; Ø 3,5mm		
	COOLEY vascular forcpeps; straight; atraumatic; Ø 2,0mm		
020-722-16		15,0cm; 6"	
020-722-20		20,0cm; 8"	
020-722-24		24,0cm; 9,6"	
020-741-09	Cilia forcpeps; straight; serrated	9,0cm; 3,6"	

Weitere Artikel
further items



Art.Nr.	Beschreibung Description	Size	Spez.
Other items available but not illustrated			
020-748-09	ZIEGLER Cilia forcepd; straight; smooth	9,0cm; 3,6"	
020-750-12 020-750-18	TROELTSCH (WILDE) ear and nose forceps; angled; serrated	12,0cm; 4,8" 18,0cm; 7,2"	
020-752-12	TROELTSCH (WILDE) ear and nose forceps; angled; 1X2 teeth	12,0cm; 4,8"	
020-754-13	TROELTSCH (WILDE) ear and nose forceps angled; serrated; selfretaining	13,0cm; 5,2"	
020-758-14	LUCAE ear dressing forceps; bayonet shaped; smooth; 1X2 teeth	14,0cm; 5,6"	
020-792-20	GRUENWALD nasal tampon forceps bayonet shaped; smooth; 1X2 teeth	20,0cm; 8"	
020-797-22	JACKSON tampon forcpe; curved; serrated; non-toothed	22,0cm; 8,8"	
020-798-10 020-799-10	KUEHNE Cover glas forceps straight curved	10,5cm; 4,2"	
020-800-05 020-800-07 020-800-10 020-801-05 020-801-07 020-801-10 020-802-05 020-802-07 020-802-10 020-803-05 020-803-07 020-803-10	GRAEFE Iris forceps straight; serrated; Ø 0,5mm straight; serrated; Ø 0,7mm straight; serrated; Ø 1,0mm curved; serrated; Ø 0,5mm curved; serrated; Ø 0,7mm curved; serrated; Ø 1,0mm straight; 1X2 teeth; Ø 0,5mm straight; 1X2 teeth; Ø 0,7mm straight; 1X2 teeth; Ø 1,0mm curved; 1X2 teeth; Ø 0,5mm curved; 1X2 teeth; Ø 0,7mm curved; 1X2 teeth; Ø 1,0mm	7,0cm; 2,8"	
020-806-10 020-807-10	Splinter forceps straight angled	10,0cm; 4"	
020-809-10	Micro forceps; smooth; selfretaining	10,0cm; 4"	
020-810-07 020-811-07 020-813-07 020-814-07 020-815-07 020-817-07	GRAEFE Iris forceps straight; serrated slightly curved; serrated strong curved; serrated straight; 1X2 teeth slightly curved; 1X2 teeth strong curved; 1X2 teeth	7,0cm; 2,8"	

020

Weitere Artikel
further items

Art.Nr.	Beschreibung Description	Size	Spez.
Other items available but not illustrated			
020-818-01	STEVENS Iris forceps; straight; 1X2 teeth; with catch	11,0cm; 4,4"	
020-820-01	STEVENS Iris forceps straight; serrated	10,5cm; 4,2"	
020-820-02	slightly curved; serrated		
020-820-03	strong curved; serrated		
020-821-01	straight; 1X2 teeth		
020-821-02	slightly curved; 1X2 teeth		
020-821-03	strong curved; 1X2 teeth		
020-826-08	FOERSTER Iris forceps straight; serrated	8,5cm; 3,4"	
020-827-08	curved; serrated		
020-828-08	straight; 1X2 teeth		
020-829-08	curved; 1X2 teeth		
020-834-01	BONN Iris forceps straight; 1X2 teeth; with guide pin	7,0cm; 2,8"	
020-834-02	straight; 1X2 teeth; without guide pin		
020-836-08	BISHOP-HARMAN Iris forceps straight; serrated	8,5cm; 3,4"	
020-838-08	straight; 1X2 teeth		
020-840-08	straight; serrated; fine		
020-842-08	straight; 1X2 teeth; fine		
020-848-09	KIRBY-ARTUR fixation forceps; curved; 1X2 teeth	9,0cm; 3,6"	
020-851-07	TROUTMAN(CORNEAL) Iris forceps; curved; 1X2 teeth	7,5cm; 3"	
020-852-07	BARRAQUER-KATZIN Iris forceps; curved; 1X2 teeth	7,0cm; 2,8"	
020-856-07	GILL -HESS Iris forceps curved; 1X2 teeth on side	7,5cm; 3"	
020-857-07	curved; 1X2 teeth below		
020-865-09	TERSON capsular forceps; curved; 5X6 teeth	9,0cm; 3,6"	
020-885-01	GRAEFE fixation forceps straight; toothed; without catch	11,0cm; 4,4"	
020-885-02	straight; toothed; with catch		
020-892-11	ELSCHNIG fixation forceps; straight; 1X2 teeth	11,0cm; 4,4"	
020-896-02	LESTER fixation forceps straight; 1X2 teeth	9,0cm; 3,6"	
020-896-03	straight; 2X3 teeth		



Art.Nr.	Beschreibung Description	Size	Spez.
Other items available but not illustrated			
020-898-10	MOORFIELD; suture forceps; straight; serrated; with guide pin	10,0cm; 4"	
020-910-07	BARRAQUER anterior chamber forceps; curved; 7mm	5,5cm; 2,2"	
020-912-07	ST.MARTIN suture forceps; straight; 1X2 teeth	7,0cm; 2,8"	
020-916-01	CASTROVIEJO suture forceps straight; 1X2 teeth; Ø 0,12mm	10,0cm; 4"	
020-916-03	straight; 1X2 teeth; Ø 0,3mm		
020-916-05	straight; 1X2 teeth; Ø 0,5mm		
020-916-10	straight; 1X2 teeth; Ø 1,0mm		
020-916-15	straight; 1X2 teeth; Ø 1,5mm		
020-917-05	curved; 1X2 teeth; Ø 0,5mm		
020-917-10	curved; 1X2 teeth; Ø 1,0mm		
020-917-15	curved; 1X2 teeth; Ø 1,5mm		
020-924-01	BONACCOLTO suture forceps straight; serrated	10,0cm; 4"	
020-924-02	straight; serrated; fine		
020-926-10	MODELL TÜBINGEN suture forceps; straight; sharp	10,0cm; 4"	
020-928-10	PAUFIQUE suture forceps; straight; 1X2 teeth	10,0cm; 4"	
020-932-01	BLASCOVICS muscular forceps left; with fixation screw	9,0cm; 3,6"	
020-932-02	right; with fixation screw		
020-938-02	AYER chalazion forceps; with fixation screw	9,0cm; 3,6"	
020-940-01	DESMARRES chalazion forceps 20 mm; with fixation screw	9,0cm (3,6")	
020-940-02	DESMARRES chalazion forceps 25 mm; with fixation screw		
020-940-03	DESMARRES chalazion forceps 31 mm; with fixation screw		
020-970-01	LONDON COLLEGE cotton plier fig. 1; curved; serrated	15,0cm; 6"	
020-970-03	fig. 3; angled; serrated		
020-970-05	fig. 5; angled; serrated		
020-973-07	fig. 7; self locking		
020-973-08	fig. 8; self locking		
020-976-01	MERIAM cotton plier fig. 1; slightly curved; serrated	16,0cm; 6,4"	
020-976-03	fig. 3; curved; serrated		
020-976-04	fig. 4; curved; smooth		
020-976-05	fig. 5; strong curved; serrated		

Weitere Artikel
further items

Art.Nr.	Beschreibung Description	Size	Spez.
Other items available but not illustrated			
020-978-01	FLAGG cotton plier fig. 1; slightly curved; serrated	16,0cm; 6,4"	
020-978-02	fig. 2; slightly curved; smooth		
020-978-03	fig. 3; curved; serrated		
020-978-04	fig. 4; curved; smooth		
020-983-01	PERRY dental forceps fig. 1; curved; serrated	12,5cm; 5"	
020-983-02	fig. 2; angled; serrated		

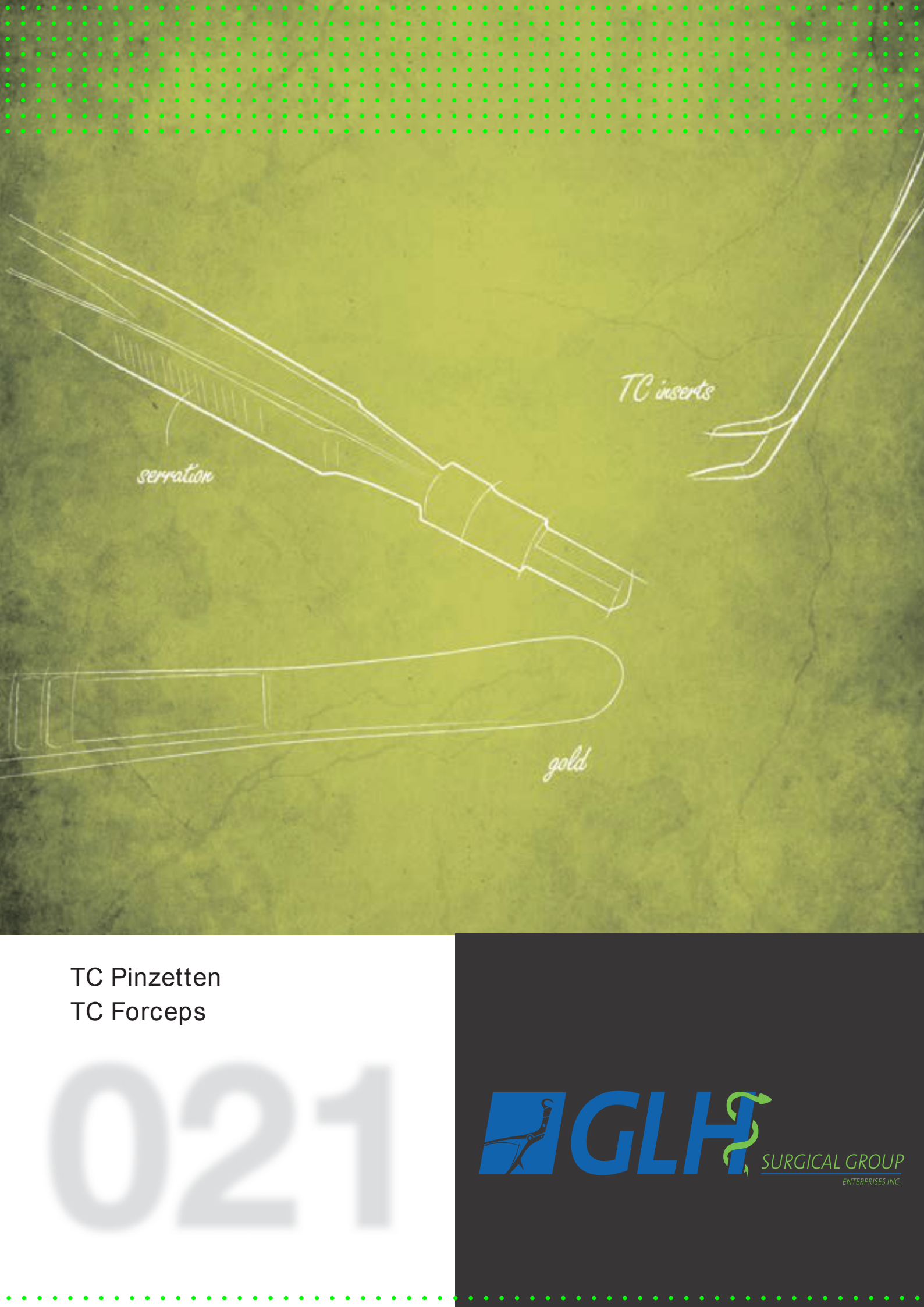

serration

TC inserts

gold

TC Pinzetten
TC Forceps

021

Pinzetten mit Hartmetalleinlagen
Forceps with tungsten carbide inserts



Hartmetalleinlagen mit präzise gearbeitetem
Pyramidenprofil.
Sicheres und schonendes Fassen von
Gefäßen, Gewebe und Nahtmaterial.
Vergoldete Federenden als leichte
Kennzeichnung.

Tungsten carbide inserts with precisely
worked out structure.
Firm and gentle grip of vessels, tissues
and sutures.
Gold-plated ends for easy identification.

Pinzetten mit Hartmetalleinlagen
 Forceps with tungsten carbide inserts

Art.Nr. Beschreibung | Description Size Spez.

POTTS-SMITH



021-026-15		15,0cm; 6"
021-026-18		18,0cm; 7"
021-026-20		20,0cm; 8"
021-026-23		23,0cm; 9"
021-026-25		25,0cm; 9 3/4"

1/1 0 mm 20 mm

SEMKEN



021-040-15		15,0cm; 6"
021-040-18		18,0cm; 7"
021-240-15	1x2	15,0cm; 6"
021-240-18	1x2	18,0cm; 7"

1/1 0 mm 20 mm

Pinzetten mit Hartmetalleinlagen
 Forceps with tungsten carbide inserts



Art.Nr.	Beschreibung Description	Size	Spez.
	CUSHING	17,5cm; 6 7/8"	

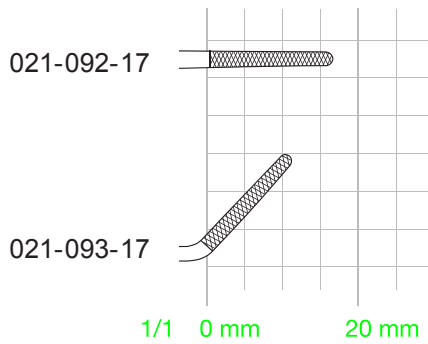

GERALD



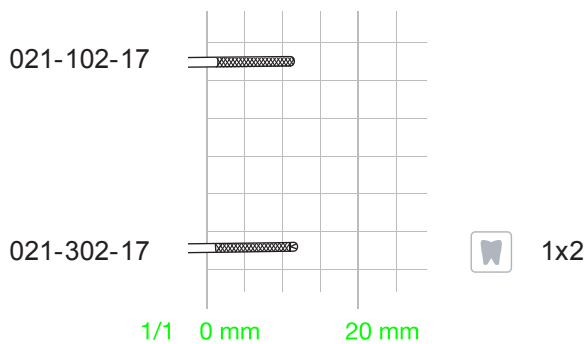

17,0cm; 6 3/4"

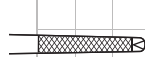
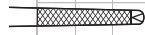

Pinzetten mit Hartmetalleinlagen
 Forceps with tungsten carbide inserts

Art.Nr.	Beschreibung Description	Size	Spez.
	OEHLER		 1x2









021-228-14		14,5cm; 5 3/4"
021-228-16		16,0cm; 6 1/4"
021-228-18		18,0cm; 7"
021-228-20		20,0cm; 8"
021-228-25		25,0cm; 9 3/4"
021-228-30		30,0cm; 11 3/4"

1/1 0 mm 20 mm

ADSON



021-070-12		12,0cm; 4 3/4"	
021-070-15		15,0cm; 6"	
021-270-12		 1x2 12,0cm; 4 3/4"	
021-270-15		 1x2 15,0cm; 6"	

1/1 0 mm 20 mm

Pinzetten mit Hartmetalleinlagen
 Forceps with tungsten carbide inserts



Art.Nr. Beschreibung | Description Size Spez.

MICRO-ADSON

 1x2



021-276-12

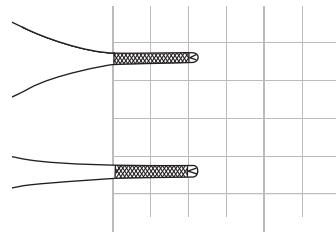

12,0cm; 4 3/4"

021-276-15

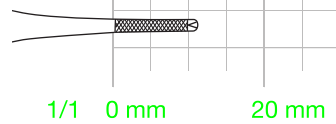

15,0cm; 6"

1/1 0 mm 20 mm

021-288-12

ADSON-BROWN

12,0cm; 4 3/4"

 2x3

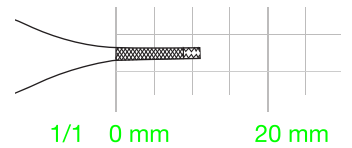

1/1 0 mm 20 mm

021-117-18

CUSHING

18,0cm; 7"

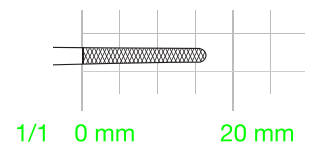

1/1 0 mm 20 mm

Pinzetten mit Hartmetalleinlagen
 Forceps with tungsten carbide inserts

Art.Nr. Beschreibung | Description Size Spez.

WANGENSTEEN



021-140-15

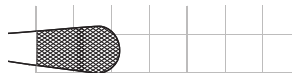

15,0cm; 6"

021-140-23

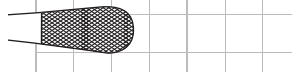

23,0cm; 9"

1/1 0 mm 20 mm

021-158-15

MC INDOE

15,0cm; 6"

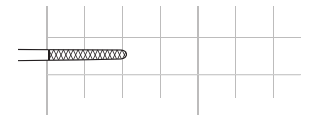

1/1 0 mm 20 mm

021-300-15

GILLIES

15,0cm; 6"

 1x2

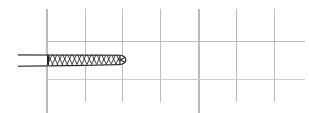

1/1 0 mm 20 mm

021-590-17

BONNEY

17,5cm; 6 7/8"

 1x2

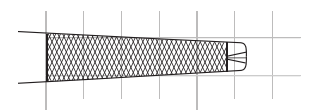

1/1 0 mm 20 mm

Pinzetten mit Hartmetalleinlagen
 Forceps with tungsten carbide inserts



Art.Nr. Beschreibung | Description Size Spez.

DE BAKEY

ATRAUMA



Art.Nr.	Beschreibung Description	Size
021-700-16	1,5 mm	16,0cm; 6 1/4"
021-700-20	1,5 mm	20,0cm; 8"
021-700-24	1,5 mm	24,0cm; 9"
021-702-16	2,0 mm	16,0cm; 6 1/4"
021-702-20	2,0 mm	20,0cm; 8"
021-702-24	2,0 mm	24,0cm; 9"

1/1 0 mm 20 mm

Weitere Artikel
further items

Art.Nr.	Beschreibung Description	Size	Spez.
Other items available but not illustrated			
021-020-14 021-020-16	TC STANDARD dressing forceps; straight; serrated; Ø 1,8mm	13,5cm; 5,4" 16,0cm; 6,4"	
021-028-18	TC POTTS-SMITH dressing forceps straight; serrated; dissector end	18,0cm 7,2"	
021-040-12	TC SEMKEN dressing forceps; straight; serrated	12,5cm; 5"	
021-076-12 021-076-15	TC MICRO-ADSON dressing forceps straight; serrated; jaw 1,1+/-0,2	12,0cm; 4,8" 15,0cm; 6"	
021-102-18	TC GERALD dressing forceps; straight; serrated	18,0cm; 7,2"	
021-120-18	TC BONNEY dressing forceps; straight; serrated	17,5cm; 7"	
021-140-25	TC WANGENSTEEN dressing forceps; straight; cross serrated	25,0cm; 10"	
021-200-14 021-200-16 021-200-18 021-200-20 021-200-25 021-200-30	TC STANDARD dressing forceps; straight; serrated	14,5cm; 5,8" 16,0cm; 6,4" 18,0cm; 7,2" 20,0cm; 8" 25,0cm; 10" 30,0cm; 12"	
021-228-17	TC OEHLER tissue forceps; straight; serrated; 1X2 teeth	17,0cm; 6,8"	
021-240-16	TC SEMKEN tissue forceps; straight; serrated; 1X2 teeth	16,0cm; 6,4"	
021-700-15 021-702-15	DE BAKEY vascular forceps straight; atraumatic; Ø 1,5mm straight; atraumatic; Ø 2mm	15,0cm; 6"	
021-703-16	DE BAKEY vascular forceps; angled; atraumatic; Ø 2mm	16,0cm; 6,4"	
021-726-25	EVANS forceps; straight; atraumatic; Ø 2mm	25,0cm; 10"	
021-976-03	TC MERIAM cotton plier; fig. 3; curved; serrated	16,0cm; 6,4"	

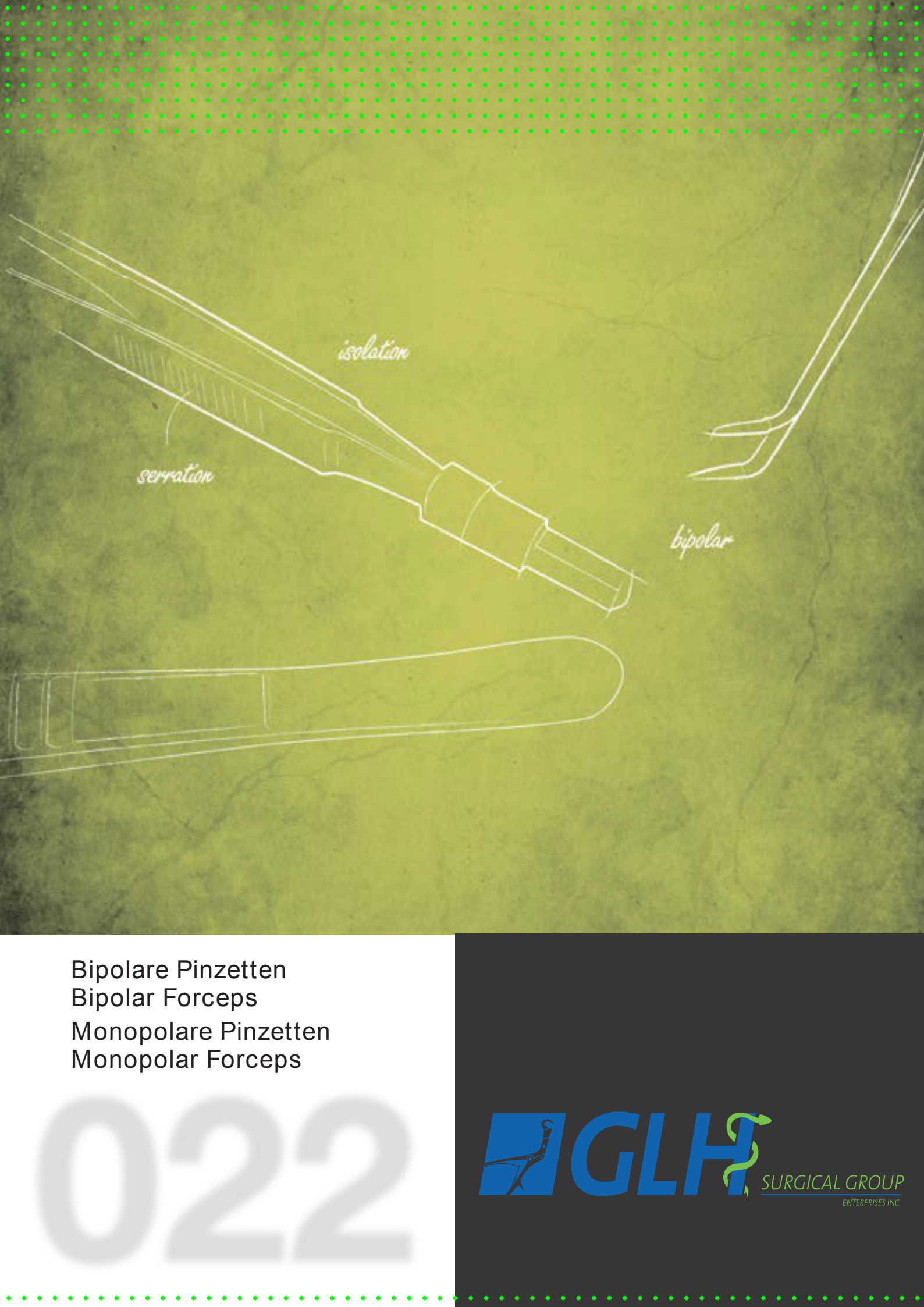

Bipolare Pinzetten
Bipolar Forceps
Monopolare Pinzetten
Monopolar Forceps

022

Bipolare Pinzetten
Bipolar Forceps



022

Art.Nr. Beschreibung | Description Size Spez.

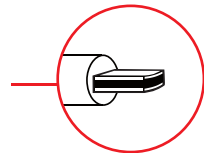

15,0cm; 6" 18,0cm; 7" 20,0cm; 8" 22,0cm; 8 3/4" 24,0cm; 9 1/2"

0,3 mm	022-100-15	022-100-18	022-100-20	022-100-22	022-100-24	
1,0 mm	022-102-15	022-102-18	022-102-20	022-102-22	022-102-24	
2,0 mm	022-104-15	022-104-18	022-104-20	022-104-22	022-104-24	

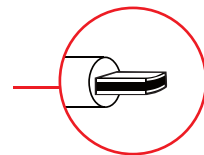

15,0cm; 6" 18,0cm; 7" 20,0cm; 8" 22,0cm; 8 3/4" 24,0cm; 9 1/2"



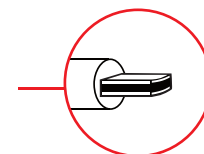

0,3 mm	022-101-15	022-101-18	022-101-20	022-101-22	022-101-24	
1,0 mm	022-103-15	022-103-18	022-103-20	022-103-22	022-103-24	
2,0 mm	022-105-15	022-105-18	022-105-20	022-105-22	022-105-24	





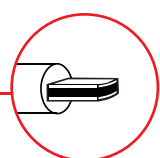

17,0cm; 6 3/4"

0,3 mm	022-107-03	
1,0 mm	022-107-10	
2,0 mm	022-107-20	

Bipolare Pinzetten Bipolar Forceps

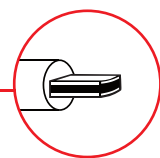
Art.Nr.	Beschreibung Description		Size			Spez.
						
	16,0cm; 6 1/4"	18,0cm; 7"	20,0cm; 8"	22,0cm; 8 3/4"	24,0cm; 9 1/2"	
0,3 mm	022-110-16	022-110-18	022-110-20	022-110-22	022-110-24	
1,0 mm	022-112-16	022-112-18	022-112-20	022-112-22	022-112-24	
2,0 mm	022-114-16	022-114-18	022-114-20	022-114-22	022-114-24	

						
	18,0cm; 7"	20,0cm; 8"	22,0cm; 8 3/4"	24,0cm; 9 1/2"		
0,3 mm	022-121-18	022-121-20	022-121-22	022-121-24		
1,0 mm	022-123-18	022-123-20	022-123-22	022-123-24		
2,0 mm	022-125-18	022-125-20	022-125-22	022-125-24		

						
	18,0cm; 7"	20,0cm; 8"	22,0cm; 8 3/4"	24,0cm; 9 1/2"		
0,3 mm	022-131-18	022-131-20	022-131-22	022-131-24		
1,0 mm	022-133-18	022-133-20	022-133-22	022-133-24		
2,0 mm	022-135-18	022-135-20	022-135-22	022-135-24		

Bipolare Pinzetten
Bipolar Forceps



022

Art.Nr.	Beschreibung Description	Size	Spez.
	MC PHERSON	7,0cm; 3"	



0,25 mm  022-210-25

0,45 mm  022-210-45

MC PHERSON

7,0cm; 3"

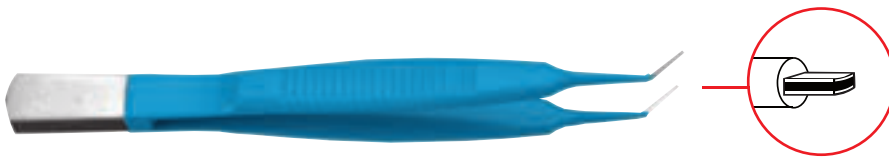

0,25 mm  022-211-25

0,45 mm  022-211-45

Bipolare Pinzetten
Bipolar Forceps

Art.Nr.	Beschreibung Description	Size	Spez.
---------	----------------------------	------	-------

JEWELLER

11,0cm; 4 1/4"

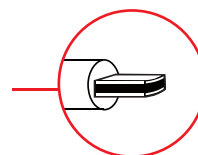

0,25 mm



022-220-25

0,6 mm



022-220-60

JEWELLER

11,0cm; 4 1/4"

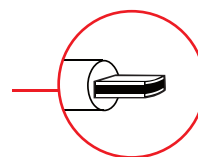

0,25 mm



022-221-25

0,6 mm



022-221-60

Bipolare Pinzetten
Bipolar Forceps



022

Art.Nr.	Beschreibung Description	Size	Spez.
	JEWELLER	11,0cm; 4 1/4"	

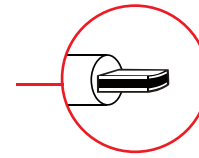

0,25 mm



022-223-25

0,6 mm



022-223-60

Monopolare Pinzetten
Monopolar Forceps

Art.Nr.	Beschreibung Description	Size	Spez.
---------	----------------------------	------	-------



023



- 023-002-14 14,5cm; 5 1/2"
- 023-002-18 18,0cm; 7"
- 023-002-21 21,0cm; 8 1/2"
- 023-002-25 25,0cm; 10"
- 023-002-30 30,0cm; 12"

 1x2



- 023-012-14 14,5cm; 5 1/2"
- 023-012-18 18,0cm; 7"
- 023-012-21 21,0cm; 8 1/2"
- 023-012-25 25,0cm; 10"
- 023-012-30 30,0cm; 12"



Alphabetisches Verzeichnis

A			
ADLERKREUTZ, chirurgische Pinzette.....	020.15	chirurgische Pinzette, CUSHING.....	020.13
ADSON, anatomische Pinzette	020.5, 020.6	chirurgische Pinzette, DURANTE	020.16
ADSON, anatomische Pinzette, TC.....	021.5	chirurgische Pinzette, fein	020.8
ADSON, chirurgische Pinzette	020.12	chirurgische Pinzette, GERALD.....	020.13
ADSON, chirurgische Pinzette, TC.....	021.5	chirurgische Pinzette, GILLIES.....	020.13
ADSON-BROWN, chirurgische Pinzette	020.12	chirurgische Pinzette, GILLIES, TC	021.7
ADSON-BROWN, chirurgische Pinzette, TC.....	021.6	chirurgische Pinzette, LERCHE.....	020.15
anatomische Mikropinzette	020.27	chirurgische Pinzette, MAYO.....	020.16
anatomische Pinzette.....	020.2	chirurgische Pinzette, MICRO-ADSON	020.12
anatomische Pinzette, ADSON	020.5, 020.6	chirurgische Pinzette, MICRO-ADSON, TC.....	021.6
anatomische Pinzette, ADSON, TC.....	021.5	chirurgische Pinzette, MOD. USA	020.9
anatomische Pinzette, BONNEY	020.7	chirurgische Pinzette, monopolar.....	022.7
anatomische Pinzette, BROPHY.....	020.6	chirurgische Pinzette, NELSON.....	020.17
anatomische Pinzette, CUSHING.....	020.5	chirurgische Pinzette, OEHLER, TC	021.5
anatomische Pinzette, CUSHING, TC.....	021.4, 021.6	chirurgische Pinzette, POTTS-SMITH	020.10
anatomische Pinzette, fein	020.3	chirurgische Pinzette, RUSS. MODELL.....	020.16
anatomische Pinzette, GERALD.....	020.6	chirurgische Pinzette, SEMKEN	020.9, 020.10
anatomische Pinzette, GERALD, TC	021.4	chirurgische Pinzette, SEMKEN, TC	021.3
anatomische Pinzette, MC INDOE	020.7	chirurgische Pinzette, SINGLEY-TUTTLE.....	020.17
anatomische Pinzette, MC INDOE, TC.....	021.7	chirurgische Pinzette, STILLE	020.9
anatomische Pinzette, MICRO-ADSON	020.5	chirurgische Pinzette, STILLE-BARRAYA.....	020.13
anatomische Pinzette, MOD. USA	020.3, 020.4	chirurgische Pinzette, STONE.....	020.15
anatomische Pinzette, monopolar.....	022.7	chirurgische Pinzette, TAYLOR.....	020.14
anatomische Pinzette, POTTS-SMITH	020.4	chirurgische Pinzette, WAUGH.....	020.14
anatomische Pinzette, POTTS-SMITH, TC	021.3	Cilienpinzette, BARRAQUER.....	020.24
anatomische Pinzette, RAMSEY	020.7	Cilienpinzette, BEER.....	020.24
anatomische Pinzette, schmal	020.2	Cilienpinzette, DOUGLAS.....	020.24
anatomische Pinzette, SEMKEN	020.5	Cilienpinzette, LITTAUER.....	020.24
anatomische Pinzette, SEMKEN, TC	021.3	CUSHING, anatomische Pinzette.....	020.5
anatomische Pinzette, STILLE	020.4	CUSHING, anatomische Pinzette, TC	021.4
anatomische Pinzette, TAYLOR.....	020.6, 020.7	CUSHING, chirurgische Pinzette.....	020.13
anatomische Pinzette, WANGENSTEEN, TC	021.7		
anatomische Pinzette, WAUGH	020.7	D	
atraumatische Pinzette, DE BAKEY	020.23	DE BAKEY, atraumatische Pinzette	020.23
atraumatische Pinzette, DE BAKEY, TC	021.8	DE BAKEY, atraumatische Pinzette, TC	021.8
		DOUGLAS, Cilienpinzette.....	020.24
		DURANTE, chirurgische Pinzette	020.16
B			
BARRAQUER, Cilienpinzette.....	020.24	F	
BEER, Cilienpinzette.....	020.24	FEILCHENFELD, Splitterpinzette	020.19
bipolare Koagulationspinzette	022.2- 022.3		
BONNEY, anatomische Pinzette.....	020.7	G	
BONNEY, chirurgische Pinzette.....	020.16	GERALD, anatomische Pinzette.....	020.6
BONNEY, chirurgische Pinzette, TC	021.7	GERALD, anatomische Pinzette, TC	021.4
BROPHY, anatomische Pinzette.....	020.6	GERALD, chirurgische Pinzette.....	020.13
		GERALD, chirurgische Pinzette, TC	021.4
C		GILLIES, chirurgische Pinzette	020.13
chirurgische Mikropinzette	020.27	GILLIES, chirurgische Pinzette, TC	021.7
chirurgische Pinzette	020.8, 020.11	GRAEFE, Irispinzette	020.26
chirurgische Pinzette, ADLERKREUTZ.....	020.15	GRÜNWALD, Ohrpinzette	020.25
chirurgische Pinzette, ADSON	020.12		
chirurgische Pinzette, ADSON, TC.....	021.5	H	
chirurgische Pinzette, ADSON-BROWN	020.12	HUNTER, Splitterpinzette.....	020.19
chirurgische Pinzette, ADSON-BROWN, TC.....	021.6		
chirurgische Pinzette, BONNEY	020.16	I	
chirurgische Pinzette, BONNEY, TC	021.7	Irispinzette, GRAEFE.....	020.26

Alphabetisches Verzeichnis

J

JANSEN, Ohrpinzette020.25, 020.26
JEWELLER, bipolare Koagulationspinzette.....022.5, 022.6

K

Koagulationspinzette, bipolar022.2, 022.3
Koagulationspinzette, bipolar, JEWELLER.....022.5, 022.6
Koagulationspinzette, bipolar, MC PHERSON022.4

L

LERCHE, chirurgische Pinzette020.15
LITTAUER, Cilienpinzette.....020.24

M

MAYO, chirurgische Pinzette.....020.16
MC INDOE, anatomische Pinzette020.7
MC INDOE, anatomische Pinzette, TC.....021.7
MC PHERSON, bipolare Koagulationspinzette022.4
MICRO-ADSON, anatomische Pinzette020.5
MICRO-ADSON, chirurgische Pinzette020.12
MICRO-ADSON, chirurgische Pinzette, TC.....021.6
Mikropinzette, anatomisch020.27
Mikropinzette, chirurgisch020.27
MOD. USA, anatomische Pinzette020.3, 020.4
monopolare anatomische Pinzette.....022.7

N

NELSON, chirurgische Pinzette.....020.17

O

OEHLER, chirurgische Pinzette, TC021.5
Ohrpinzette, GRÜNWALD020.25
Ohrpinzette, JANSEN020.25, 020.26
Ohrpinzette, TROELTSCH020.25

P

PEET, Splitterpinzette020.21
Pinzette, anatomisch020.2
Pinzette, anatomisch, ADSON020.5, 020.6
Pinzette, anatomisch, ADSON, TC.....021.5
Pinzette, anatomisch, BONNEY020.7
Pinzette, anatomisch, BROPHY020.6
Pinzette, anatomisch, CUSHING.....020.5
Pinzette, anatomisch, CUSHING, TC021.4, 021.6
Pinzette, anatomisch, fein020.3
Pinzette, anatomisch, GERALD.....020.6
Pinzette, anatomisch, GERALD, TC021.4
Pinzette, anatomisch, MC INDOE020.7
Pinzette, anatomisch, MC INDOE, TC.....021.7
Pinzette, anatomisch, MICRO-ADSON020.5
Pinzette, anatomisch, MOD. USA020.3, 020.4
Pinzette, anatomisch, monopolar022.7
Pinzette, anatomisch, POTTS-SMITH020.4
Pinzette, anatomisch, POTTS-SMITH, TC021.3
Pinzette, anatomisch, RAMSEY020.7
Pinzette, anatomisch, schmal020.2

Pinzette, anatomisch, SEMKEN020.5
Pinzette, anatomisch, SEMKEN, TC021.3
Pinzette, anatomisch, STILLE020.4
Pinzette, anatomisch, TAYLOR.....020.6, 020.7
Pinzette, anatomisch, WANGENSTEEN, TC021.7
Pinzette, anatomisch, WAUGH020.7
Pinzette, atraumatisch, DE BAKEY020.23
Pinzette, atraumatisch, DE BAKEY, TC021.8
Pinzette, chirurgisch020.8, 020.11
Pinzette, chirurgisch, ADLERKREUTZ020.15
Pinzette, chirurgisch, ADSON020.12
Pinzette, chirurgisch, ADSON, TC.....021.5
Pinzette, chirurgisch, ADSON-BROWN020.12
Pinzette, chirurgisch, ADSON-BROWN, TC021.6
Pinzette, chirurgisch, BONNEY020.16
Pinzette, chirurgisch, BONNEY, TC.....021.7
Pinzette, chirurgisch, CUSHING.....020.13
Pinzette, chirurgisch, DURANTE020.16
Pinzette, chirurgisch, fein020.8
Pinzette, chirurgisch, GERALD.....020.13
Pinzette, chirurgisch, GILLIES.....020.13
Pinzette, chirurgisch, GILLIES, TC021.7
Pinzette, chirurgisch, LERCHE020.15
Pinzette, chirurgisch, MAYO.....020.16
Pinzette, chirurgisch, MICRO-ADSON020.12
Pinzette, chirurgisch, MICRO-ADSON, TC021.6
Pinzette, chirurgisch, MOD. USA020.9
Pinzette, chirurgisch, monopolar.....022.7
Pinzette, chirurgisch, NELSON020.17
Pinzette, chirurgisch, OEHLER, TC021.5
Pinzette, chirurgisch, POTTS-SMITH020.10
Pinzette, chirurgisch, RUSS. MODELL.....020.16
Pinzette, chirurgisch, SEMKEN020.9, 020.10
Pinzette, chirurgisch, SEMKEN, TC021.3
Pinzette, chirurgisch, SINGLEY-TUTTLE.....020.17
Pinzette, chirurgisch, STILLE020.9
Pinzette, chirurgisch, STILLE-BARRAYA.....020.13
Pinzette, chirurgisch, STONE020.15
Pinzette, chirurgisch, TAYLOR.....020.14
Pinzette, chirurgisch, WAUGH020.14
Pinzette, Cilien-, BARRAQUER020.24
Pinzette, Cilien-, BEER.....020.24
Pinzette, Cilien-, DOUGLAS020.24
Pinzette, Cilien-, LITTAUER.....020.24
Pinzette, Iris-, GRAEFE020.26
Pinzette, Koagulations-, bipolar022.2, 022.3
Pinzette, Koagulations-, JEWELLER, bipolar022.5, 022.6
Pinzette, Koagulations-, MC PHERSON, bipolar022.4
Pinzette, Mikro-, anatomisch.....020.27
Pinzette, Mikro-, chirurgisch.....020.27
Pinzette, Ohr-, GRÜNWALD020.25
Pinzette, Ohr-, JANSEN.....020.25, 020.26
Pinzette, Ohr-, TROELTSCH.....020.25
Pinzette, Splitter-020.19, 020.20
Pinzette, Splitter-, FEILCHENFELD020.19
Pinzette, Splitter-, HUNTER020.19
Pinzette, Splitter-, PEET020.21



Alphabetisches Verzeichnis

Pinzette, Splitter-, RALK.....	020.22
Pinzette, Splitter-, STIEGLITZ	020.21
Pinzette, Uhrmacher.....	020.18
POTTS-SMITH, anatomische Pinzette	020.4
POTTS-SMITH, anatomische Pinzette, TC	021.3
POTTS-SMITH, chirurgische Pinzette	020.10
Pinzette, Splitter-, PEET	020.21
Pinzette, Splitter-, RALK.....	020.22
Pinzette, Splitter-, STIEGLITZ	020.21
Pinzette, Uhrmacher.....	020.18
POTTS-SMITH, anatomische Pinzette	020.4
POTTS-SMITH, anatomische Pinzette, TC	021.3
POTTS-SMITH, chirurgische Pinzette	020.10

R

RALK, Splitterpinzette	020.22
RAMSEY, anatomische Pinzette.....	020.7
RUSS. MODELL, chirurgische Pinzette.....	020.16

S

SEMKEN, anatomische Pinzette	020.5
SEMKEN, anatomische Pinzette, TC	021.3
SEMKEN, chirurgische Pinzette	020.9, 020.10
SEMKEN, chirurgische Pinzette, TC	021.3
SINGLEY-TUTTLE, chirurgische Pinzette.....	020.17
Splitterpinzette	020.19, 020.20
Splitterpinzette, FEILCHENFELD	020.19
Splitterpinzette, HUNTER.....	020.19
Splitterpinzette, PEET.....	020.21
Splitterpinzette, RALK	020.22
Splitterpinzette, STIEGLITZ.....	020.21
STIEGLITZ, Splitterpinzette.....	020.21
STILLE, anatomische Pinzette	020.4
STILLE, chirurgische Pinzette	020.9
STILLE-BARRAYA, chirurgische Pinzette.....	020.13
STONE, chirurgische Pinzette	020.15

T

TAYLOR, anatomische Pinzette.....	020.6, 020.7
TAYLOR, chirurgische Pinzette.....	020.14
TROELTSCH, Ohrpinzette	020.25

U

Uhrmacher Pinzette.....	020.18
-------------------------	--------

W

WANGENSTEEN, anatomische Pinzette, TC	021.7
WAUGH, anatomische Pinzette	020.7
WAUGH, chirurgische Pinzette.....	020.14

Index, alphabetical

A	
ADLERKREUTZ, tissue forceps.....	020.15
ADSON, dressing forceps.....	020.5, 020.6
ADSON, dressing forceps, TC.....	021.5
ADSON, tissue forceps.....	020.12
ADSON, tissue forceps, TC.....	021.5
ADSON-BROWN, tissue forceps.....	020.12
ADSON-BROWN, tissue forceps, TC.....	021.6
atraumatic dressing forceps, DE BAKEY.....	020.23
atraumatic dressing forceps, DE BAKEY, TC.....	021.8
B	
BARRAQUER, cilia forceps.....	020.24
BEER, cilia forceps.....	020.24
bipolar coagulation forceps.....	022.2, 022.3
BONNEY, dressing forceps.....	020.7
BONNEY, tissue forceps.....	020.16
BONNEY, tissue forceps, TC.....	021.7
BROPHY, dressing forceps.....	020.6
C	
cilia forceps, BARRAQUER.....	020.24
cilia forceps, BEER.....	020.24
cilia forceps, DOUGLAS.....	020.24
cilia forceps, LITTAUER.....	020.24
coagulation forceps, bipolar.....	022.2, 022.3
coagulation forceps, JEWELLER, bipolar.....	022.5, 022.6
coagulation forceps, MC PHERSON, bipolar.....	022.4
CUSHING, dressing forceps.....	020.5
CUSHING, dressing forceps, TC.....	021.6
CUSHING, tissue forceps.....	020.13
D	
DE BAKEY, atraumatic dressing forceps.....	020.23
DE BAKEY, atraumatic dressing forceps, TC.....	021.8
DOUGLAS, cilia forceps.....	020.24
dressing forceps.....	020.2
dressing forceps, ADSON.....	020.5, 020.6
dressing forceps, ADSON, TC.....	021.5
dressing forceps, BONNEY.....	020.7
dressing forceps, BROPHY.....	020.6
dressing forceps, CUSHING.....	020.5
dressing forceps, CUSHING, TC.....	021.4, 021.6
dressing forceps, fine.....	020.3
dressing forceps, GERALD.....	020.6
dressing forceps, GERALD, TC.....	021.4
dressing forceps, MC INDOE.....	020.7
dressing forceps, MC INDOE, TC.....	021.7
dressing forceps, micro.....	020.27
dressing forceps, MOD. USA.....	020.3, 020.4
dressing forceps, monopolar.....	022.7
dressing forceps, narrow.....	020.2
dressing forceps, POTTS-SMITH.....	020.4
dressing forceps, POTTS-SMITH, TC.....	021.3
dressing forceps, RAMSEY.....	020.7
dressing forceps, SEMKEN.....	020.5
dressing forceps, SEMKEN, TC.....	021.3
dressing forceps, STILLE.....	020.4
dressing forceps, TAYLOR.....	020.6, 020.7
dressing forceps, WANGENSTEEN, TC.....	021.7
dressing forceps, WAUGH.....	020.7
dressing forceps, ear, GRÜN WALD.....	020.25
dressing forceps, ear, JANSEN.....	020.25, 020.26
dressing forceps, ear, TROELTSCH.....	020.25
dressing forceps, iris, GRAEFE.....	020.26
dressing forceps, jeweller type.....	020.18
dressing forceps, splinter.....	020.19, 020.20
dressing forceps, SEMKEN, TC.....	021.3
dressing forceps, STILLE.....	020.4
dressing forceps, TAYLOR.....	020.6, 020.7
dressing forceps, WANGENSTEEN, TC.....	021.7
dressing forceps, WAUGH.....	020.7
dressing forceps, MICRO-ADSON.....	020.5
DURANTE, tissue forceps.....	020.16
E	
ear forceps, GRÜN WALD.....	020.25
ear forceps, JANSEN.....	020.25, 020.26
ear forceps, TROELTSCH.....	020.25
F	
FEILCHENFELD, splinter forceps.....	020.19
forceps, atraumatic, dressing, DE BAKEY, TC.....	021.8
forceps, cilia, BARRAQUER.....	020.24
forceps, cilia, BEER.....	020.24
forceps, cilia, DOUGLAS.....	020.24
forceps, cilia, LITTAUER.....	020.24
forceps, coagulation, bipolar.....	022.2, 022.3
forceps, coagulation, JEWELLER, bipolar.....	022.5, 022.6
forceps, coagulation, MC PHERSON, bipolar.....	022.4
forceps, dressing.....	020.2
forceps, dressing, ADSON.....	020.5, 020.6
forceps, dressing, ADSON, TC.....	021.5
forceps, dressing, atraumatic, DE BAKEY.....	020.23
forceps, dressing, BONNEY.....	020.7
forceps, dressing, BROPHY.....	020.6
forceps, dressing, CUSHING.....	020.5
forceps, dressing, CUSHING, TC.....	021.4, 021.6
forceps, dressing, fine.....	020.3
forceps, dressing, GERALD.....	020.6
forceps, dressing, GERALD, TC.....	021.4
forceps, dressing, MC INDOE.....	020.7
forceps, dressing, MC INDOE, TC.....	021.7
forceps, dressing, micro.....	020.27
forceps, dressing, MICRO-ADSON.....	020.5
forceps, dressing, MOD. USA.....	020.3, 020.4
forceps, dressing, monopolar.....	022.7
forceps, dressing, narrow.....	020.2
forceps, dressing, POTTS-SMITH.....	020.4
forceps, dressing, POTTS-SMITH, TC.....	021.3
forceps, dressing, RAMSEY.....	020.7
forceps, dressing, SEMKEN.....	020.5
forceps, dressing, SEMKEN, TC.....	021.3
forceps, dressing, STILLE.....	020.4
forceps, dressing, TAYLOR.....	020.6, 020.7
forceps, dressing, WANGENSTEEN, TC.....	021.7
forceps, dressing, WAUGH.....	020.7
forceps, ear, GRÜN WALD.....	020.25
forceps, ear, JANSEN.....	020.25, 020.26
forceps, ear, TROELTSCH.....	020.25
forceps, iris, GRAEFE.....	020.26
forceps, jeweller type.....	020.18
forceps, splinter.....	020.19, 020.20



Index, alphabetical

forceps, splinter, FEILCHENFELD	020.19	forceps, tissue, TAYLOR.....	020.14
forceps, splinter, HUNTER.....	020.19	forceps, tissue, WAUGH.....	020.14
forceps, splinter, PEET	020.21	G	
forceps, splinter, RALK.....	020.22	GERALD, dressing forceps, TC.....	021.4
forceps, splinter, STIEGLITZ.....	020.21	GERALD, dressing forcpe.....	020.6
forceps, tissue	020.8, 020.11	GERALD, tissue forceps.....	020.13
forceps, tissue, ADLERKREUTZ.....	020.15	GILLIES, tissue forceps.....	020.13
forceps, tissue, ADSON	020.12	GILLIES, tissue forceps, TC	021.7
forceps, tissue, ADSON, TC.....	021.5	GRAEFE, iris forceps	020.26
forceps, tissue, ADSON-BROWN.....	020.12	GRÜN WALD, ear forceps	020.25
forceps, tissue, ADSON-BROWN, TC.....	021.6	H	
forceps, tissue, BONNEY	020.16	HUNTER, splinter forceps	020.19
forceps, tissue, BONNEY, TC	021.7	I	
forceps, tissue, CUSHING.....	020.13	iris forceps, GRAEFE	020.26
forceps, tissue, DURANTE	020.16	J	
forceps, tissue, GERALD.....	020.13	JANSEN, ear forceps.....	020.25, 020.26
forceps, tissue, GILLIES	020.13	jeweller type forceps	020.18
forceps, tissue, GILLIES, TC	021.7	JEWELLER, bipolar coagulation forceps	022.5, 022.6
forceps, tissue, LERCHE.....	020.15	L	
forceps, tissue, MAYO.....	020.16	LERCHE, tissue forceps	020.15
forceps, splinter, FEILCHENFELD	020.19	LITTAUER, cilia forceps.....	020.24
forceps, splinter, HUNTER.....	020.19	M	
forceps, splinter, PEET	020.21	MAYO, tissue forceps	020.16
forceps, splinter, RALK.....	020.22	MC INDOE, dressing forceps	020.7
forceps, splinter, STIEGLITZ.....	020.21	MC INDOE, dressing forceps, TC	021.7
forceps, tissue	020.8, 020.11	MC PHERSON, bipolar coagulation forceps.....	022.4
forceps, tissue, ADLERKREUTZ.....	020.15	micro dressing forceps.....	020.27
forceps, tissue, ADSON	020.12	micro tissue forceps	020.27
forceps, tissue, ADSON, TC.....	021.5	MICRO-ADSON, dressing forceps	020.5
forceps, tissue, ADSON-BROWN.....	020.12	MICRO-ADSON, tissue forceps	020.12
forceps, tissue, ADSON-BROWN, TC.....	021.6	MICRO-ADSON, tissue forceps, TC.....	021.6
forceps, tissue, BONNEY	020.16	MOD. USA, dressing forceps	020.3, 020.4
forceps, tissue, BONNEY, TC	021.7	MOD. USA, tissue forceps	020.9
forceps, tissue, CUSHING.....	020.13	monopolar tissue forceps.....	022.7
forceps, tissue, DURANTE	020.16	N	
forceps, tissue, GERALD.....	020.13	NELSON, tissue forceps.....	020.17
forceps, tissue, GILLIES	020.13	O	
forceps, tissue, GILLIES, TC	021.7	OEHLER, tissue forceps, TC	021.5
forceps, tissue, LERCHE.....	020.15	P	
forceps, tissue, MAYO.....	020.16	PEET, splinter forceps	020.21
forceps, tissue, micro	020.27	POTTS-SMITH, dressing forceps	020.4
forceps, tissue, MICRO-ADSON	020.12	POTTS-SMITH, dressing forceps, TC	021.3
forceps, tissue, MICRO-ADSON, TC.....	021.6	POTTS-SMITH, tissue forceps	020.10
forceps, tissue, MOD. USA	020.9		
forceps, tissue, monopolar.....	022.7		
forceps, tissue, narrow	020.8		
forceps, tissue, NELSON.....	020.17		
forceps, tissue, OEHLER, TC	021.5		
forceps, tissue, POTTS-SMITH	020.10		
forceps, tissue, RUSS. MODEL.....	020.16		
forceps, tissue, SEMKEN	020.9, 020.10		
forceps, tissue, SEMKEN, TC.....	021.3		
forceps, tissue, SINGLEY-TUTTLE.....	020.17		
forceps, tissue, STILLE	020.9		
forceps, tissue, STILLE-BARRAYA.....	020.13		
forceps, tissue, STONE	020.15		

Index, alphabetical

R

RALK, splinter forceps	020.22
RAMSEY, dressing forceps.....	020.7
RUSS. MODEL, tissue forceps.....	020.16

S

SEMKEN, dressing forceps	020.5
SEMKEN, dressing forceps, TC	021.3
SEMKEN, tissue forceps	020.9
SEMKEN, tissue forceps, TC.....	021.3
SINGLEY-TUTTLE, tissue forceps.....	020.17
splinter forceps.....	020.19, 020.20
splinter forceps, FEILCHENFELD.....	020.19
splinter forceps, HUNTER.....	020.19
splinter forceps, PEET.....	020.21
splinter forceps, RALK.....	020.22
splinter forceps, STIEGLITZ.....	020.21
STIEGLITZ, splinter forceps.....	020.21
STILLE, dressing forceps	020.4
STILLE, tissue forceps	020.9
STILLE-BARRAYA, tissue forceps.....	020.13
STONE, tissue forceps	020.15

T

TAYLOR, dressing forceps	020.6, 020.7
TAYLOR, tissue forceps.....	020.14
tissue forceps	020.8, 020.11
tissue forceps, ADLERKREUTZ.....	020.15
tissue forceps, ADSON	020.12
tissue forceps, ADSON, TC.....	021.5
tissue forceps, ADSON-BROWN.....	020.12
tissue forceps, ADSON-BROWN, TC.....	021.6
tissue forceps, BONNEY	020.16
tissue forceps, BONNEY, TC.....	021.7
tissue forceps, CUSHING.....	020.13
tissue forceps, DURANTE.....	020.16
tissue forceps, GERALD.....	020.13
tissue forceps, GILLIES.....	020.13
tissue forceps, GILLIES, TC	021.7
tissue forceps, LERCHE.....	020.15
tissue forceps, MAYO.....	020.16
tissue forceps, micro	020.27
tissue forceps, MICRO-ADSON	020.12
tissue forceps, MICRO-ADSON, TC.....	021.6
tissue forceps, MOD. USA	020.9
tissue forceps, monopolar.....	022.7
tissue forceps, narrow	020.8
tissue forceps, NELSON.....	020.17
tissue forceps, OEHLER, TC	021.5
tissue forceps, POTTS-SMITH	020.10
tissue forceps, RUSS. MODEL.....	020.16
tissue forceps, SEMKEN	020.9, 020.10
tissue forceps, SEMKEN, TC.....	021.3
tissue forceps, SINGLEY-TUTTLE.....	020.17
tissue forceps, STILLE	020.9
tissue forceps, STILLE-BARRAYA.....	020.13

tissue forceps, STONE.....	020.15
tissue forceps, TAYLOR.....	020.14
tissue forceps, WAUGH.....	020.14
TROELTSCH, ear forceps.....	020.25

W

WANGENSTEEN, dressing forceps, TC	021.7
WAUGH, dressing forceps	020.7
WAUGH, tissue forceps.....	020.14