



Klemmen  
Clamps

026

Gefäßclips; Anlegepinzetten  
Vessel Clips; Applying Forceps



Art.Nr. Beschreibung | Description Size Spez.



026-500-04

2,0 mm

10,0 mm

125 g



026-500-03

2,0 mm

8,0 mm

100 g



026-500-02

1,0 mm

6,0 mm

85 g



026-500-01

0,75 mm

4,0 mm

60 g

D

M

S

026-502-14

mit Sperre | with ratchet |

14,0cm; 5 1/2"



026-503-18

mit Sperre | with ratchet |

18,0cm; 7"



S

Schließkraft  
Closing Force

O

Maulöffnung  
Opening of jaws

M

Maullänge  
Length of jaws

D

Durchmesser  
Diameter

Gefäßclips; Anlegepinzetten  
Vessel Clips; Applying Forceps

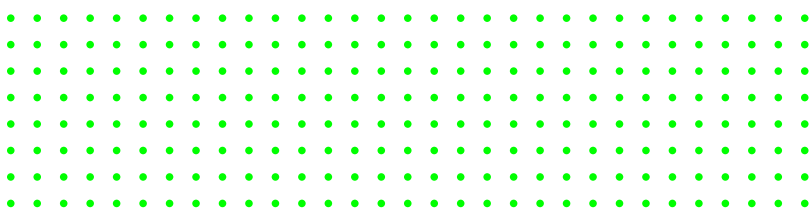



Art.Nr. Beschreibung | Description Size Spez.

BIEMER

O

M

S

			
	026-506-01	026-506-02	026-506-03
	4,0 mm	5,0 mm	5,0 mm
	6,0 mm	9,0 mm	9,0 mm
	30 – 40 g (0,29 – 0,39 N)	30 – 40 g (0,29 – 0,39 N)	20 – 25 g (0,20 – 0,25 N)



026

026-508-01

14,5cm; 5 3/4"



026-508-02

mit Schloss | with lock |

14,5cm; 5 3/4"



Approximatoren; Anlegepinzetten  
 Approximators; Applying Forceps



Art.Nr. Beschreibung | Description Size Spez.

MÜLLER

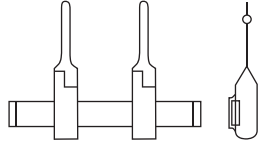
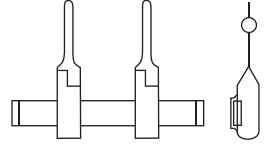
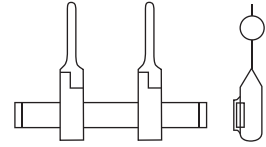
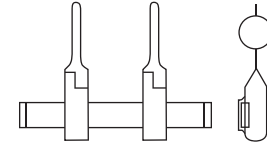
	026-530-01	026-530-02	026-530-03	026-530-04
   				
<b>D</b>	1,0 mm	2,0 mm	3,0 mm	4,0 mm
<b>S</b>	25 – 30 g (0,25 – 0,29 N)	25 – 30 g (0,25 – 0,29 N)	25 – 30 g (0,25 – 0,29 N)	25 – 30 g (0,25 – 0,29 N)
<b>M</b>	9,0 mm	9,0 mm	9,0 mm	9,0 mm
<b>O</b>	5,0 mm	5,0 mm	5,0 mm	5,0 mm

026-508-01

14,5cm; 5 3/4"



026-508-02

mit Schloss | with lock |

14,5cm; 5 3/4"



- S** Schließkraft  
Closing Force
- O** Maulöffnung  
Opening of jaws
- M** Maullänge  
Length of jaws
- D** Durchmesser  
Diameter

Art.Nr. Beschreibung | Description Size Spez.

BIEMER-MÜLLER

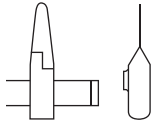
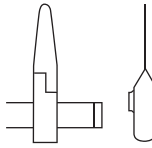
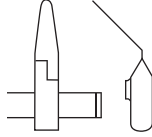
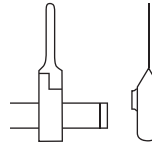
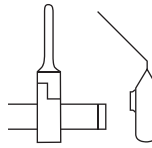
Art.Nr.	Beschreibung   Description	Size	Spez.	
				
026-540-06	026-540-09	026-541-08	026-540-07	026-541-07
3,0 mm	5,0 mm	5,0 mm	5,0 mm	5,0 mm
6,0 mm	9,0 mm	7,5 mm	7,0 mm	7,0 mm
30 – 40 g	30 – 40 g	30 – 40 g	30 – 40 g	30 – 40 g

O

M

S

Approximatoren  
Approximators



Art.Nr.	Beschreibung   Description	Size	Spez.
026-564-00	<p>Approximator (026-564-10) mit Schlüssel (026-564-01), für Mikro-Gefäßanastomosen im tieferen Bereich. Schließdruck wird mit dem Schlüssel eingestellt.</p> <p>Approximator (026-564-10) with key (026-564-01), for micro vessel anastomosis in the deeper range. The pressure measure is adjusted with the key.</p>		

026

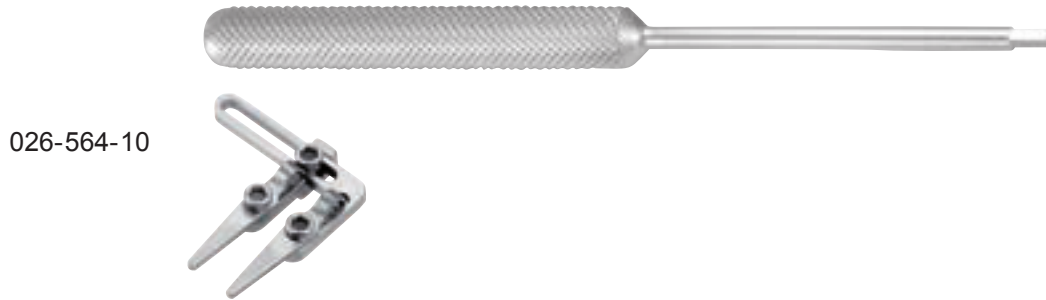

026-564-10

026-566-00	<p>Nerv-Approximator (026-566-10) mit Schlüssel (026-564-01), zur sicheren Adaption bei Nervanastomosen. Nadeln mit Schlüssel auswechselbar.</p> <p>Approximator for nerves (026-566-10) with key (026-564-01), for safe adaptation of nerve anastomoses. The needles can be exchanged with the key.</p>		
------------	--	--	--



026-564-01

026-566-10

026-566-02	<p>1 Paar Ersatznadeln 1 Pair of spare needles</p>		
------------	--	--	--

Bulldogklemmen  
Bulldog Clamps

Art.Nr.	Beschreibung   Description	Size	Spez.
---------	----------------------------	------	-------

DIEFFENBACH

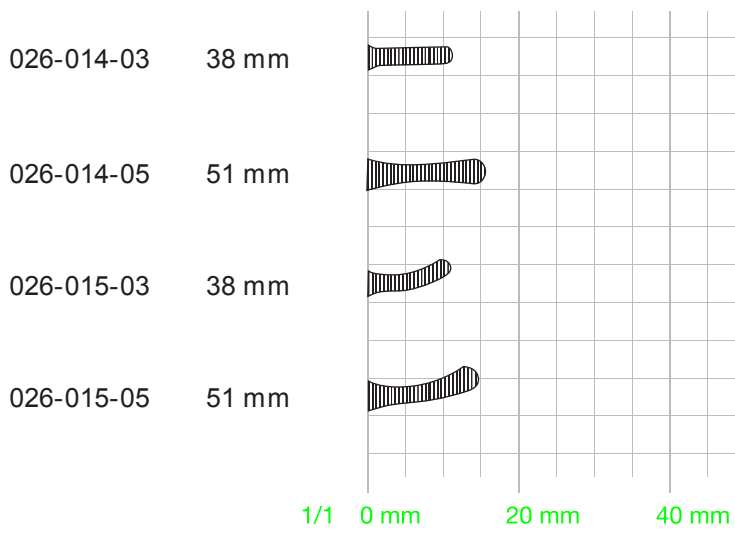

Bulldogklemmen  
Bulldog Clamps



Art.Nr.	Beschreibung   Description	Size	Spez.
---------	----------------------------	------	-------

JOHNS-HOPKINS



- 026-018-04 38 mm
- 026-018-05 51 mm
- 026-018-06 63 mm
- 026-018-07 75 mm
- 026-018-09 90 mm

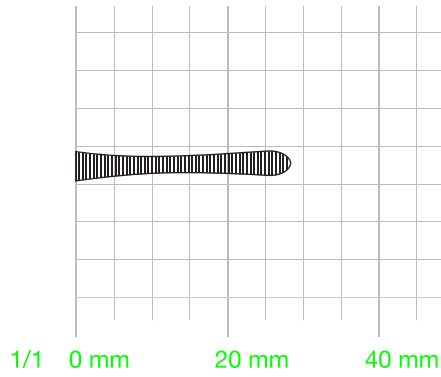

- 026-019-04 38 mm
- 026-019-05 51 mm
- 026-019-06 63 mm
- 026-019-07 75 mm
- 026-019-09 90 mm

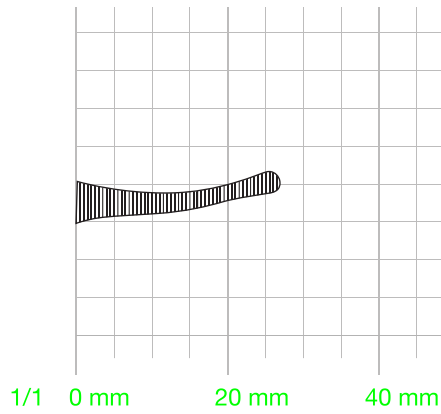





026



Art.Nr. Beschreibung | Description Size Spez.

DIETHRICH

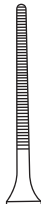

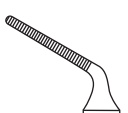
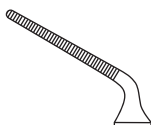
						
	026-020-01	026-020-02	026-020-03	026-021-01	026-021-02	026-021-03
<b>L</b>	45 mm	50 mm	60 mm	40 mm	45 mm	50 mm
<b>M</b>	8,0 mm	12,0 mm	20,0 mm	8,0 mm	12,0 mm	20,0 mm
<b>S</b>	50 g	50 g	50 g	50 g	50 g	50 g
<b>G</b>	3 g	3 g	3 g	3 g	3 g	3 g

026

**S** Schließkraft  
Closing Force

**G** Gewicht  
Weight

**M** Maullänge  
Length of jaws

**L** Länge  
Length





Art.Nr. Beschreibung | Description Size Spez.

DE BAKEY DIETHRICH

ATRAUMA

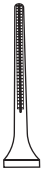
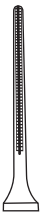

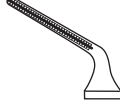
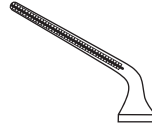
					
026-022-01	026-022-02	026-022-03	026-023-01	026-023-02	026-023-03
45 mm	50 mm	60 mm	35 mm	45 mm	50 mm
10,0 mm	14,0 mm	20,0 mm	10,0 mm	14,0 mm	20,0 mm
180 g	180 g	180 g	180 g	180 g	180 g
3 g	3 g	3 g	3 g	3 g	3 g

L

M

S

G

026-191-07

DE BAKEY-SATINSKY

7,0cm; 2 3/4"

ATRAUMA

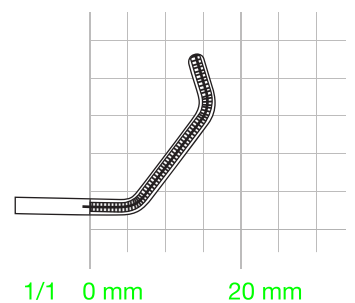

S

Schließkraft  
Closing Force

G

Gewicht  
Weight

M

Maullänge  
Length of jaws

L

Länge  
Length

Bulldogklemmen  
Bulldog Clamps

Art.Nr.	Beschreibung   Description	Size	Spez.
026-191-09	DE BAKEY-SATINSKY	9,0cm; 3 1/2"	ATRAUMA

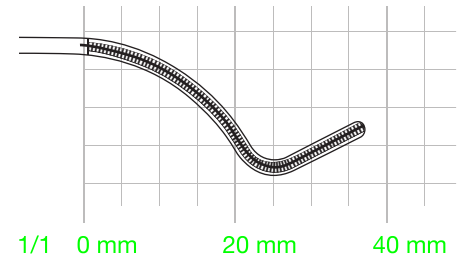

026-191-10	DE BAKEY-SATINSKY	10,0cm; 4"	ATRAUMA
------------	-------------------	------------	---------

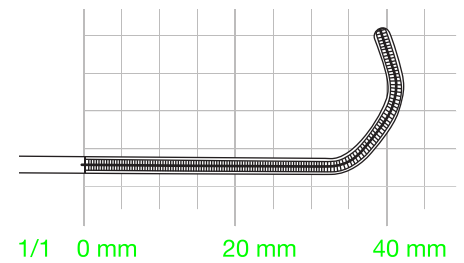

026-193-06	GLOVER	6,5cm; 2 4/8"	ATRAUMA
------------	--------	---------------	---------

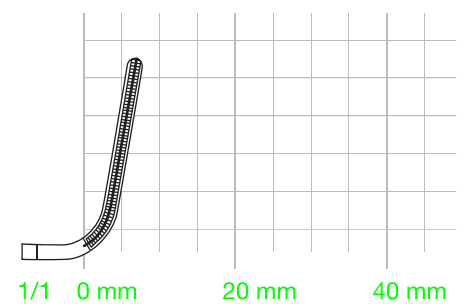

Bulldogklemmen  
Bulldog Clamps



Art.Nr.	Beschreibung   Description	Size	Spez.
026-195-07	SANTULLI	7,0cm; 2 3/4"	ATRAUMA

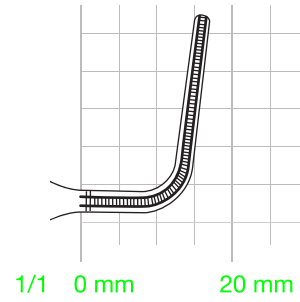

ATRAUMA

GREGORY-SOFT	Carotisklemmen Carotid Clamp
026-197-09	9,0cm; 3 1/2"
026-197-11	11,0cm; 4 3/8"

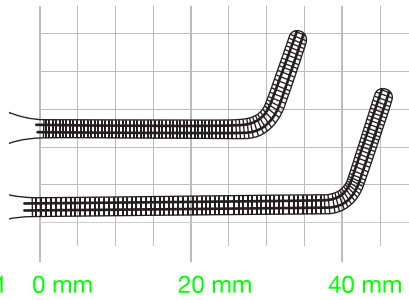

ATRAUMA

GREGORY	Carotisklemmen Carotid Clamp
026-199-01	11,0cm; 4 3/8"
026-199-02	

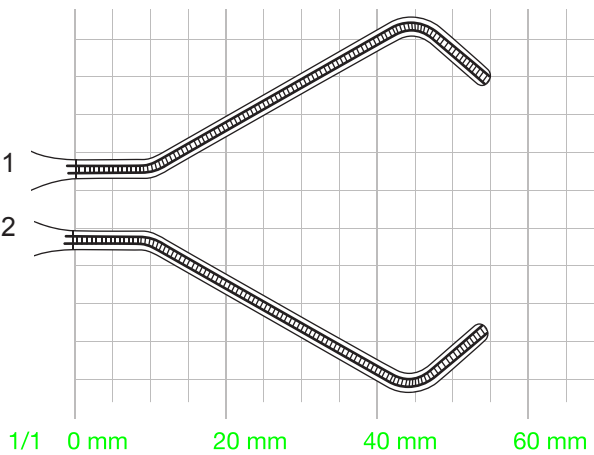

ATRAUMA

026

Bulldogklemmen; Anlegezange  
 Bulldog Clamps; Applying forceps

Art.Nr. Beschreibung | Description Size Spez.

DE BAKEY

ATRAUMA



026-292-07		7,5cm; 3"
026-292-08		8,5cm; 3 1/4"
026-292-10		10,5cm; 4"
026-292-12		12,5cm; 5"

1/1 0 mm 20 mm 40 mm 60 mm

DE BAKEY

ATRAUMA



026-293-07		8,0cm; 3 1/8"
026-293-08		9,0cm; 3 1/2"
026-293-10		10,5cm; 4"
026-293-12		12,5cm; 5"

1/1 0 mm 20 mm 40 mm 60 mm

026-295-23 JOHNS-HOPKINS 23,0cm; 9"

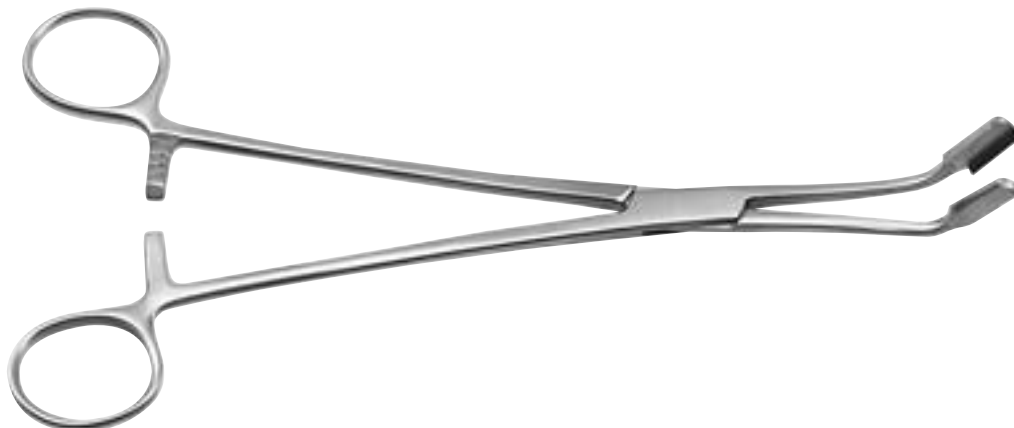

026

Bulldogklemmen  
Bulldog Clamps



Art.Nr. Beschreibung | Description Size Spez.

GLOVER

ATRAUMA

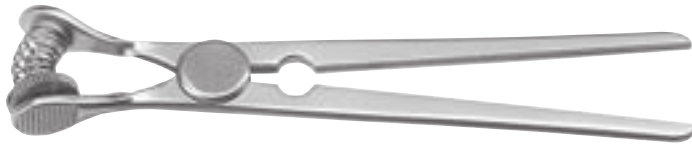

Art.Nr.	Size
026-298-06	7,0cm; 2 3/4"
026-298-07	8,0cm; 3 1/8"
026-298-09	9,5cm; 3 3/4"
026-298-11	11,0cm; 4 1/4"

1/1 0 mm 20 mm 40 mm 60 mm

GLOVER

ATRAUMA



Art.Nr.	Size
026-299-06	6,5cm; 2 1/2"
026-299-07	7,5cm; 3"
026-299-09	9,0cm; 3 1/2"
026-292-11	10,5cm; 4"

1/1 0 mm 20 mm 40 mm

026

Bulldogklemmen  
Bulldog Clamps









Art.Nr. Beschreibung | Description Size Spez.

Ti



Vena

Arteria

	Vena				Arteria			
								
	027-032-30	027-032-35	027-032-40	027-032-50	027-042-30	027-042-35	027-042-40	027-042-50
L	30 mm	35 mm	40 mm	50 mm	30 mm	35 mm	40 mm	50 mm
M	9 mm	13 mm	14 mm	23 mm	9 mm	13 mm	14 mm	23 mm
S	110 ± 10 g	110 ± 10 g	110 ± 10 g	110 ± 10 g	220 ± 10 g	220 ± 10 g	220 ± 10 g	220 ± 10 g
G	1 g	1 g	1 g	1,5 g	1 g	1 g	1 g	1,5 g

S

Schließkraft  
Closing Force

G

Gewicht  
Weight

M

Maullänge  
Length of jaws

L

Länge  
Length

Bulldogklemmen  
Bulldog Clamps



Art.Nr. Beschreibung | Description Size Spez.

Ti



Vena

Arteria

	Vena				Arteria			
	027-033-30	027-033-35	027-033-40	027-033-50	027-043-30	027-043-35	027-043-40	027-043-50
L	30 mm	35 mm	40 mm	50 mm	30 mm	35 mm	40 mm	50 mm
M	9 mm	13 mm	14 mm	23 mm	9 mm	13 mm	14 mm	23 mm
S	110 ± 10 g	110 ± 10 g	110 ± 10 g	110 ± 10 g	220 ± 10 g	220 ± 10 g	220 ± 10 g	220 ± 10 g
G	1 g	1 g	1 g	1,5 g	1 g	1 g	1 g	1,5 g

S

Schließkraft  
Closing Force

G

Gewicht  
Weight

M

Maullänge  
Length of jaws

L

Länge  
Length



Bulldogklemmen  
Bulldog Clamps

Art.Nr. Beschreibung | Description Size Spez.

Ti



Vena

Arteria

	027-035-30	027-035-35	027-035-40	027-035-50	027-045-30	027-045-35	027-045-40	027-045-50
<b>L</b>	30 mm	35 mm	40 mm	50 mm	30 mm	35 mm	40 mm	50 mm
<b>M</b>	9 mm	13 mm	14 mm	23 mm	9 mm	13 mm	14 mm	23 mm
<b>S</b>	110 ± 10 g	110 ± 10 g	110 ± 10 g	110 ± 10 g	220 ± 10 g	220 ± 10 g	220 ± 10 g	220 ± 10 g
<b>G</b>	1 g	1 g	1 g	1,5 g	1 g	1 g	1 g	1,5 g

Weitere Artikel  
further items



Art.Nr.	Beschreibung   Description	Size	Spez.
<b>Other items available but not illustrated</b>			
026-014-06	DIEFFENBACH bulldog clamp straight; length: 60mm		
026-015-06	curved; length: 60mm		
026-298-03	GLOVER bulldog clamp straight; atraumatic	3,5cm; 1,4"	
026-298-04	straight; atraumatic	4,5cm; 1,8"	
026-299-03	curved; atraumatic	3,5cm; 1,4"	
026-510-01	MEHDORN vessel clip 4x1,0mm; closing force 10-15g		
026-510-02	4x1,4mm; closing force 15-20g		
026-510-03	6x1,0mm; closing force 10-15g		
026-510-04	6x1,4mm; closing force 15-20g		
026-512-15	MEHRDORN applying forceps; straight	14,5cm; 5,6"	
026-514-50	MÜLLER vessel clip straight; jaw 11mm; closing force 50g		
026-514-80	straight; jaw 11mm; closing force 80g		
026-515-50	curved; jaw 11,5mm; closing force 50g		
026-515-80	curved; jaw 11,5mm; closing force 80g		
026-516-50	curved; jaw 16mm; closing force 50g		
026-516-80	curved; jaw 16mm; closing force 80g		
026-517-50	angled; jaw 11mm; closing force 50g		
026-517-80	angled; jaw 11mm; closing force 80g		
026-518-50	angled; jaw 10mm; closing force 50g		
026-518-80	angled; jaw 10mm; closing force 80g		
026-520-01	HESS bulldog clamp angled; jaw 20mm		
026-520-02	angled; jaw 30mm		
026-540-07	BIEMER-MÜLLER approximator; closing force 30-40g jaw opening 5,0mm; length 7,0mm		
026-541-07	jaw opening 5,0mm; length 7,0mm		
026-541-08	angled; jaw opening 5mm; length 7,5mm		

026



Klemmen  
Clamps

030

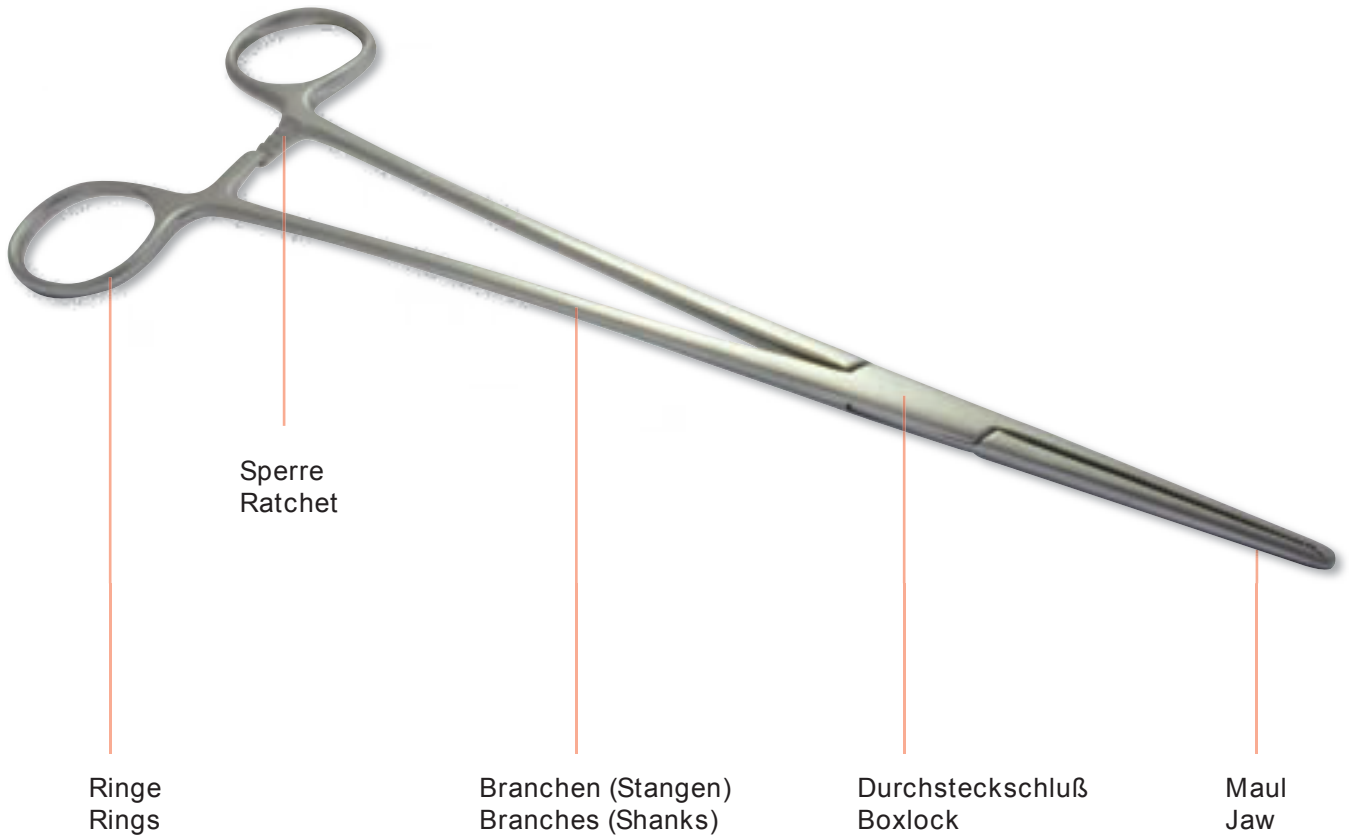

Art.Nr.	Beschreibung   Description	Size	Spez.
---------	----------------------------	------	-------

Maulbiegung gerade  
 Jaw bending straight



Maulbiegung gebogen  
 Jaw bending curved

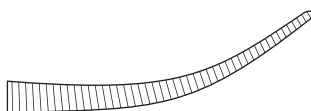

Spitzen mit 1x2 Zähnen  
 Tips with 1x2 teeth



Spitzen ohne Zähne  
 Tips without teeth



quergerieft  
 horizontal serrated



kreuzgerieft  
 cross serrated



längsgerieft  
 longitudinal serrated



Tuchklemmen  
Towel Clamps



Art.Nr.	Beschreibung   Description	Size	Spez.
---------	----------------------------	------	-------

BACKHAUS



030-000-09		9,0cm; 3 1/2"
030-000-11		11,0cm; 4 3/8"
030-000-13		13,0cm; 5 1/8"
030-000-15		15,0cm; 6"

1/1 0 mm 20 mm 40 mm

030

Tuchklemmen  
Towel Clamps

Art.Nr.	Beschreibung   Description	Size	Spez.
030-005-11	BACKHAUS mit Schlauchhalter   with clip for tubes	11,0cm; 4 3/8"	



ROEDER

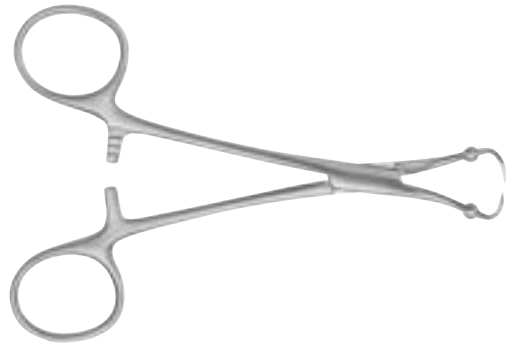

030-010-13 13,0cm; 5 1/8"

030-010-15 15,0cm; 6"



Art.Nr.	Beschreibung   Description	Size	Spez.
---------	----------------------------	------	-------

LORNA

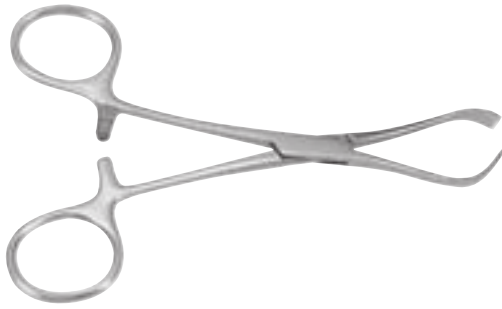

030-014-10

10,0cm; 4"

030-014-13

13,0cm; 5 1/8"

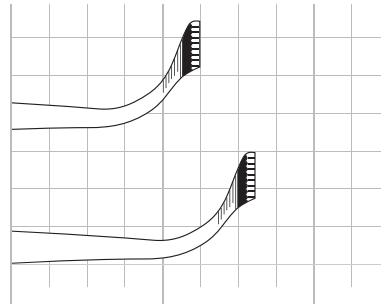

1/1 0 mm 20 mm 40 mm

TOHOKU

stumpf | blunt |



030-020-10

10,0cm; 4"

030-020-13

13,0cm; 5 1/8"

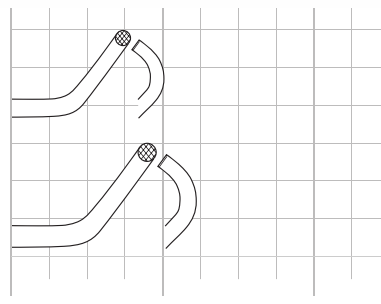

1/1 0 mm 20 mm 40 mm

030



Tuchklemmen  
Towel Clamps

Art.Nr.	Beschreibung   Description	Size	Spez.
---------	----------------------------	------	-------

für Papierabdeckung | for paper clothes



030-024-11 11,5cm; 4 1/2"

030-024-13 13,0cm; 5 1/8"

Art.Nr.	Beschreibung   Description	Size	Spez.
---------	----------------------------	------	-------

030-030-14

PEERS

14,5cm; 5 3/4"

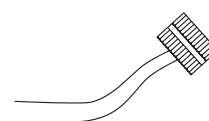

Tuchklemmen  
Towel Clamps



Art.Nr.	Beschreibung   Description	Size	Spez.
---------	----------------------------	------	-------

LANE

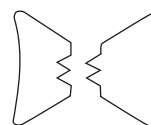
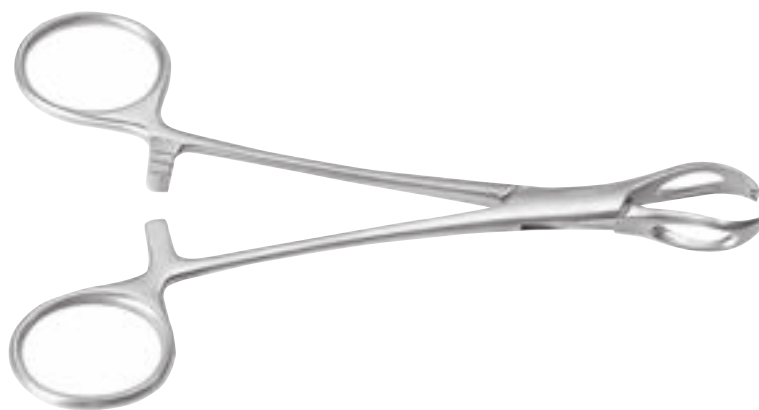

030-040-15	15,0cm; 6"		
030-040-20	20,0cm; 8"		

030-044-16	BERNHARD	16,5cm; 6 1/4"	
------------	----------	----------------	--



030-101-09	SCHAEDEL	9,0cm; 3 1/2"	
------------	----------	---------------	--



030

Tuchklemmen  
Towel Clamps

Art.Nr.	Beschreibung   Description	Size	Spez.
030-109-09	ENGL. MODELL	9,0cm; 3 1/2"	



030-105-05	JONES	5,0cm; 2"	
------------	-------	-----------	--



030-105-09	JONES	9,0cm; 3 1/2"	
------------	-------	---------------	--



030-107-09	JONES	9,0cm; 3 1/2"	
------------	-------	---------------	--

mit Schlauchhalter | with tube holder |



Schwamm- und Tupferzangen  
Sponge and Dressing Forceps



Art.Nr. Beschreibung | Description Size Spez.

FOERSTER-BALLENGER



030-160-18

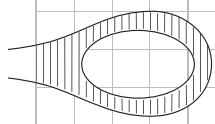

18,0cm; 7"

030-160-20

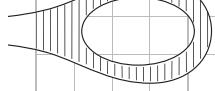

20,0cm; 8"

030-160-25



25,0cm; 9 3/4"

030-161-18

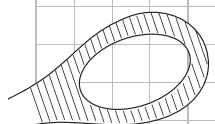

18,0cm; 7"

030-161-20



20,0cm; 8"

030-161-25



25,0cm; 9 3/4"

030-170-18

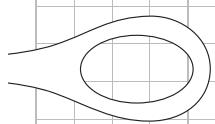

18,0cm; 7"

030-170-20



20,0cm; 8"

030-170-25



25,0cm; 9 3/4"

030-171-18

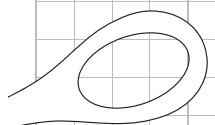

18,0cm; 7"

030-171-20



20,0cm; 8"

030-171-25



25,0cm; 9 3/4"

1/1 0 mm 20 mm 40 mm

030

Schwamm- und Tupferzangen  
Sponge and Dressing Forceps

Art.Nr.	Beschreibung   Description	Size	Spez.
---------	----------------------------	------	-------

FOERSTER

25,0cm; 9 3/4"



030-180-25

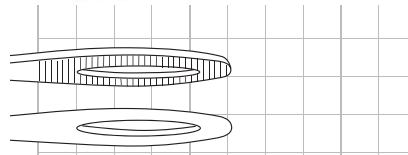

030-181-25

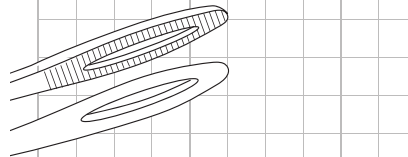

1/1 0 mm 20 mm 40 mm

RAMPLEY



030-190-18

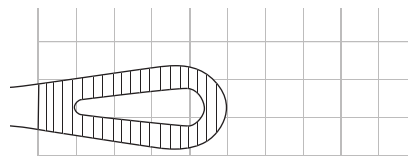

18,0cm; 7"

030-190-25

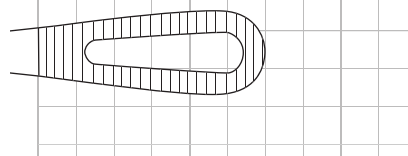

25,0cm; 9 3/4"

1/1 0 mm 20 mm 40 mm

Schwamm- und Tupferzangen  
Sponge and Dressing Forceps



Art.Nr. Beschreibung | Description Size Spez.

ULRICH



030-200-22		22,0cm; 8 3/4"
030-201-22		22,0cm; 8 3/4"
030-200-25		25,0cm; 9 3/4"
030-200-27		27,0cm; 10 3/4"
030-201-25		25,0cm; 9 3/4"
030-201-27		27,0cm; 10 3/4"

1/1 0 mm 20 mm

030

Korn- und Tupferzangen  
Cotton Swap Forceps

Art.Nr.	Beschreibung   Description	Size	Spez.
---------	----------------------------	------	-------

GROSS-MAIER

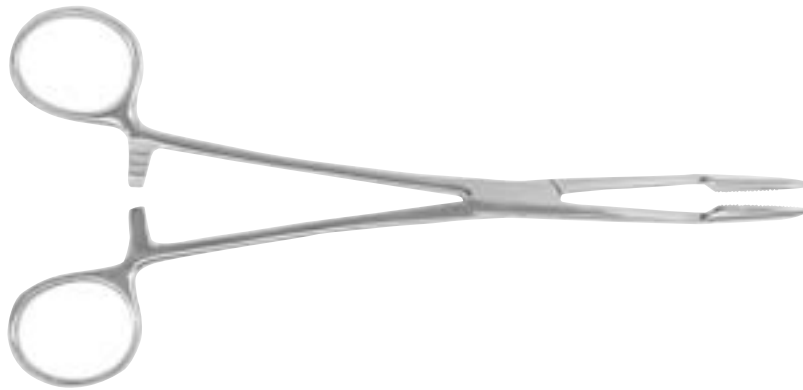

030-210-20		20,0cm; 8"
030-210-22		22,0cm; 8 3/4"
030-210-25		25,0cm; 9 3/4"
030-210-27		27,0cm; 10 3/4"
030-211-20		20,0cm; 8"
030-211-22		22,0cm; 8 3/4"
030-211-25		25,0cm; 9 3/4"
030-211-27		27,0cm; 10 3/4"

1/1 0 mm 20 mm

Korn- und Tupferzangen  
Cotton Swap Forceps



Art.Nr.	Beschreibung   Description	Size	Spez.
030-300-25	COLLIN	25,0cm; 9 3/4"	

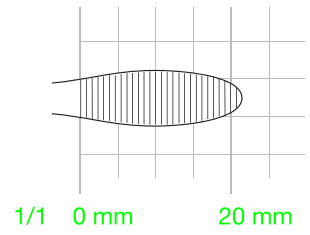
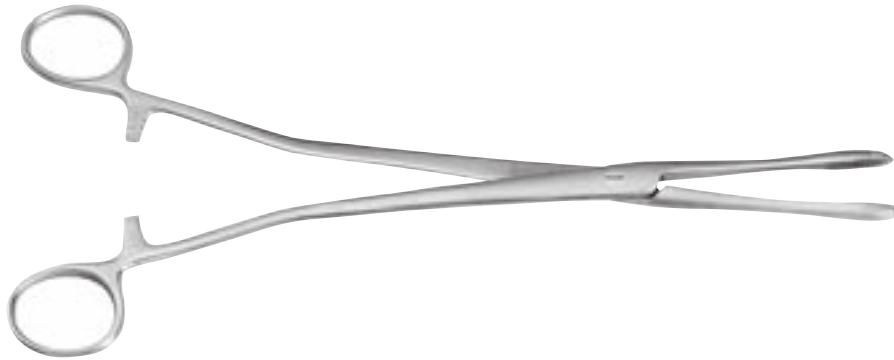

030-303-25	CHERON	25,0cm; 9 3/4"	
------------	--------	----------------	--

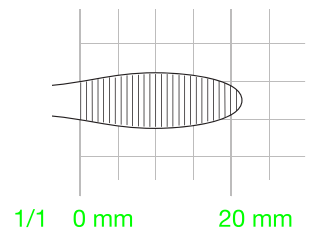
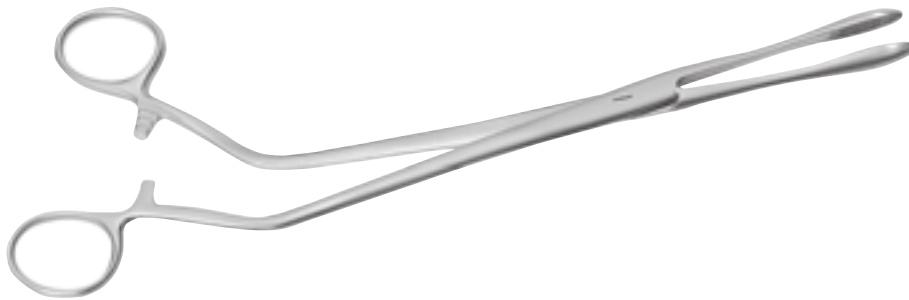

030



Korn- und Tupferzangen  
Cotton Swap Forceps

Art.Nr.	Beschreibung   Description	Size	Spez.
	BOZEMANN	26,0cm; 10 1/4"	

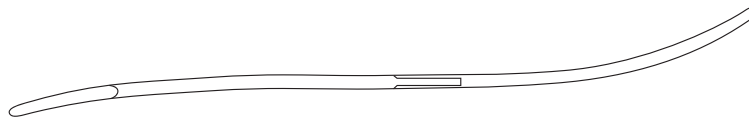
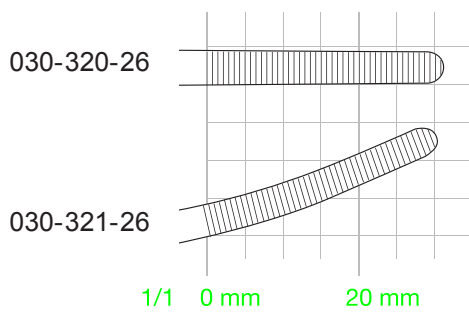

030-327-26	BOZEMANN-DOUGLAS	26,0cm; 10 1/4"	
------------	------------------	-----------------	--

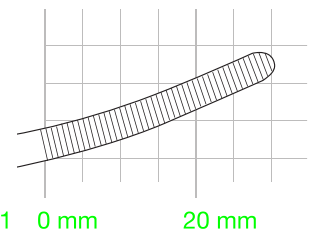
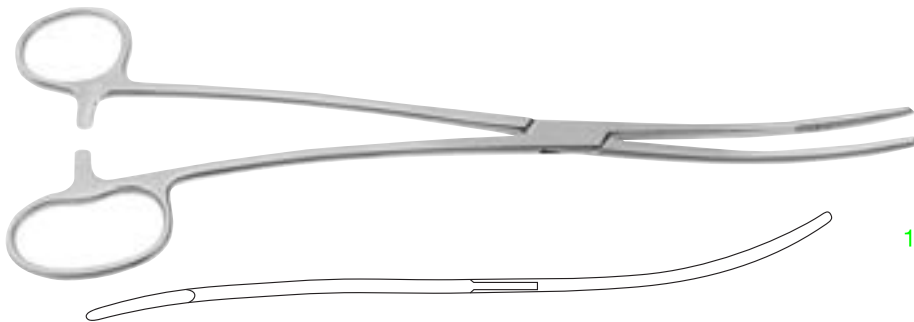

030-351-13	BRYANT	13,0cm; 5 1/8"	
------------	--------	----------------	--

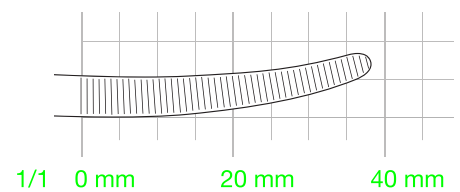

Sinusklemmen  
Sinus forceps



Art.Nr.	Beschreibung   Description	Size	Spez.
---------	----------------------------	------	-------

LISTER



- |            |  |                |
|------------|--|----------------|
| 030-360-13 |  | 13,0cm; 5 1/8" |
| 030-360-16 |  | 16,0cm; 6 1/4" |
| 030-360-18 |  | 18,0cm; 7"     |

1/1 0 mm

MARTIN

17,5cm; 7"



030-370-17

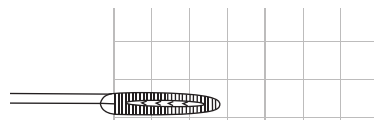

030-371-17

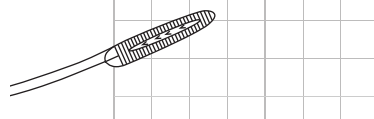

1/1 0 mm 20 mm

030

Weitere Artikel  
further items

Art.Nr.	Beschreibung   Description	Size	Spez.
<b>Other items available but not illustrated</b>			
030-110-18	DOYEN towel forceps; toothed	11,0cm; 4,4"	
030-212-20	GROSS-MAIER dressing forceps straight; serrated; without ratchet	20,0cm; 8"	
030-212-22	straight; serrated; without ratchet	22,0cm; 8,8"	
030-212-25	straight; serrated; without ratchet	25,0cm; 10"	
030-212-27	straight; serrated; without ratchet	27,0cm; 10,8"	
030-213-20	curved; serrated; without ratchet	20,0cm; 8"	
030-213-22	curved; serrated; without ratchet	22,0cm; 8,8"	
030-213-25	curved; serrated; without ratchet	25,0cm; 10"	
030-213-27	curved; serrated; without ratchet	27,0cm; 10,8"	
030-250-24	FLETCHER dressing forceps straight; serrated	24,0cm; 9,6"	
030-251-24	s-shaped; serrated		
030-260-23	WESTERMARK dressing forceps straight; serrated; without ratchet	23,0cm; 9,2"	
030-310-25	PELKMANN dressing forceps straight; serrated	25,0cm; 10"	
030-311-25	curved; serrated		
030-350-21	HEYWOOD-SMITH dressing forceps straight; serrated	21,0cm; 8,4"	
030-352-25	straight; serrated	25,0cm; 10"	
030-354-18	DOYEN Polypus and Ovum forceps; straight; serrated	18,0cm; 7,2"	



Klemmen  
Clamps

032

Schlauchklemmen  
Tubing Clamps



Art.Nr. Beschreibung | Description Size Spez.



032-002-15 15,0cm; 6"

032-002-18 18,0cm; 7"

032-002-20 20,0cm; 8"

1/1 0 mm 20 mm 40 mm

mit Schutzbügel | with safety guard |



032-004-15 15,0cm; 6"

032-004-18 18,0cm; 7"

032-004-20 20,0cm; 8"

1/1 0 mm 20 mm 40 mm

032

Schlauchklemmen  
Tubing Clamps

Art.Nr.	Beschreibung   Description	Size	Spez.
032-006-14	BERLIN	14,5cm; 5 3/4"	

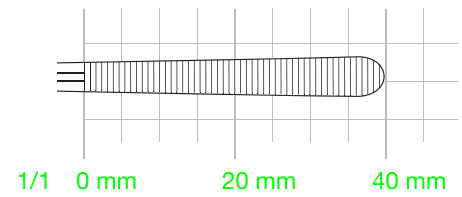
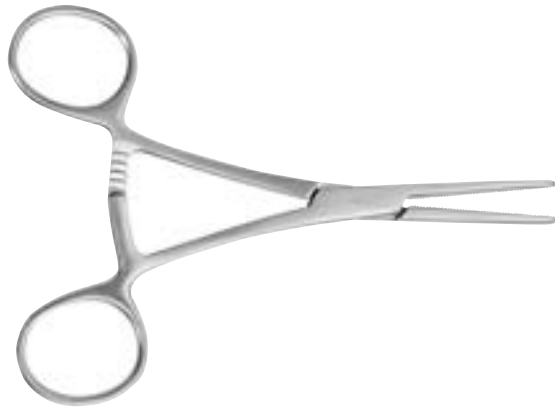

PRESBYTERIAN

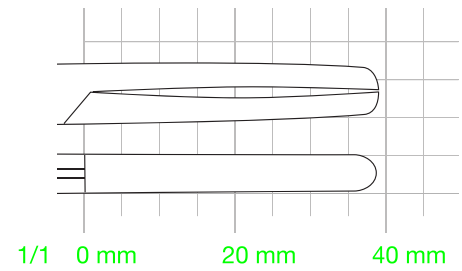
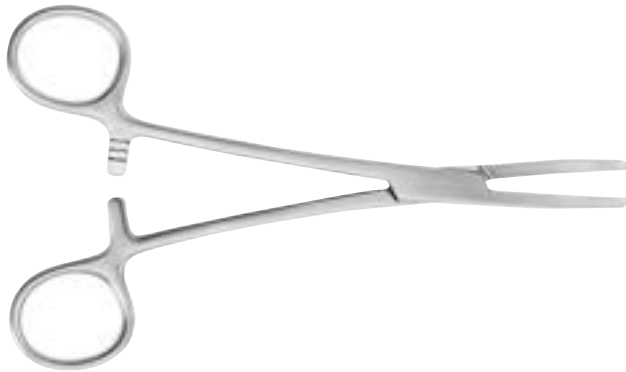

032-012-16	16,5cm; 6 1/2"
032-012-18	18,0cm; 7"
032-012-20	20,0cm; 8"

Weitere Artikel  
further items



Art.Nr.	Beschreibung   Description	Size	Spez.
<b>Other items available but not illustrated</b>			
032-020-14	Tubing clamp straight; serrated; extra long ratchet	14,5cm; 5,8"	
032-020-16	straight; serrated; extra long ratchet	16,0cm; 6,4"	
032-210-00	Tube roller squeezing forceps tef on roller, aluminium blue anodised	16,0cm; 6,4"	

## Alphabetisches Verzeichnis

### A

Anlegepinzette.....	026.2- 026.4
Anlegezange, JOHNS-HOPKINS .....	026.13
Approximator mit Schlüssel .....	026.6
Approximator, BIEMER-MÜLLER.....	026.5
Approximator, MÜLLER.....	026.4

### B

BACKHAUS, Tuchklemme.....	030.4
BERLIN, Schlauchklemme .....	032.3
BERNHARD, Tuchklemme.....	030.8
BIEMER, Gefäßclip .....	026.3
BIEMER-MÜLLER, Approximator.....	026.5
BOZEMANN, Korn- und Tupferzange .....	030.15
BOZEMANN-DOUGLAS, Korn- und Tupferzange.....	030.15
BRYANT, Korn- und Tupferzange .....	030.15
Bulldogklemme, DE BAKEY .....	026.13
Bulldogklemme, DE BAKEY DIETHRICH .....	026.10
Bulldogklemme, DE BAKEY-SATINSKY .....	026.10- 026.11
Bulldogklemme, DIEFFENBACH .....	026.7
Bulldogklemme, DIETHRICH.....	026.9
Bulldogklemme, GLOVER .....	026.11, 026.14
Bulldogklemme, JOHNS-HOPKINS .....	026.8
Bulldogklemme, SANTULLY.....	026.12
Bulldogklemme, Titan.....	026.15- 026.17

### C

Carotisklemme, GREGORY .....	026.12
Carotisklemme, GREGORY-SOFT .....	026.12
CHERON, Korn- und Tupferzange .....	030.14
Clip, Gefäß- .....	026.2
COLLIN, Korn- und Tupferzange.....	030.14

### D

DE BAKEY DIETHRICH, Bulldogklemme .....	026.10
DE BAKEY, Bulldogklemme.....	026.13
DE BAKEY-SATINSKY, Bulldogklemme.....	026.10, 026.11
DIEFFENBACH, Bulldogklemme .....	026.7
DIETHRICH, Bulldogklemme.....	026.9

### E

ENGL. MODELL, Tuchklemme .....	030.9
Ersatznadeln für Approximator.....	026.6

### F

FOERSTER, Schwammzange .....	030.11
FOERSTER-BALLANGER, Schwammzange.....	030.10

### G

Gefäßclip .....	026.2
GLOVER, Bulldogklemme .....	026.11, 026.14
GREGORY, Carotisklemmen .....	026.12
GREGORY-SOFT, Carotisklemmen .....	026.12
GROSS-MAIER, Korn- und Tupferzange.....	030.13

### J

JOHNS-HOPKINS, Anlegezange .....	026.13
JOHNS-HOPKINS, Bulldogklemme .....	026.8
JONES, Tuchklemme .....	030.9

### K

Klemme, Bulldog-, DE BAKEY .....	026.13
Klemme, Bulldog-, DE BAKEY DIETHRICH .....	026.10
Klemme, Bulldog-, DE BAKEY-SATINSKY .....	026.10, 026.11
Klemme, Bulldog-, DIEFFENBACH .....	026.7
Klemme, Bulldog-, DIETHRICH.....	026.9
Klemme, Bulldog-, GLOVER .....	026.11, 026.14
Klemme, Bulldog-, JOHNS-HOPKINS .....	026.8
Klemme, Bulldog-, SANTULLY .....	026.12
Klemme, Bulldog-, Titan.....	026.15- 026.17
Klemme, Carotis-, GREGORY .....	026.12
Klemme, Carotis-, GREGORY-SOFT.....	026.12
Klemme, Schlauch- .....	032.2
Klemme, Schlauch-, BERLIN .....	032.3
Klemme, Schlauch-, PRESBYTERIAN .....	032.3
Klemme, Tuch- .....	030.7
Klemme, Tuch-, BACKHAUS.....	030.4
Klemme, Tuch-, BERNHARD.....	030.8
Klemme, Tuch-, ENGL. MODELL .....	030.9
Klemme, Tuch-, JONES.....	030.9
Klemme, Tuch-, LANE .....	030.8
Klemme, Tuch-, LORNA .....	030.6
Klemme, Tuch-, PEERS.....	030.7
Klemme, Tuch-, ROEDER.....	030.5
Klemme, Tuch-, SCHAEDEL .....	030.8
Klemme, Tuch-, TOHOKU .....	030.6
Korn- und Tupferzange CHERON .....	030.14
Korn- und Tupferzange, BOZEMANN .....	030.15
Korn- und Tupferzange, BOZEMANN-DOUGLAS.....	030.15
Korn- und Tupferzange, BRYANT.....	030.15
Korn- und Tupferzange, COLLIN.....	030.14
Korn- und Tupferzange, GROSS-MAIER.....	030.13

### L

LANE, Tuchklemme .....	030.8
LISTER, Sinusklemme .....	030.16
LORNA, Tuchklemme .....	030.6

### M

MARTIN, Sinusklemme .....	030.16
MÜLLER, Approximator .....	026.4

### N

Nadeln, Ersatz-, 1 Paar .....	026.6
Nerv-Approximator.....	026.6
Nerv-Approximator mit Schlüssel .....	026.6

### P

PEERS, Tuchklemme.....	030.7
Pinzette, Anlege- .....	026.2- 026.4
PRESBYTERIAN, Schlauchklemme .....	032.3





## Alphabetisches Verzeichnis

### R

RAMPLEY, Schwammzange.....	030.11
ROEDER, Tuchklemme.....	030.5

### S

SANTULLY, Bulldogklemme .....	026.12
SCHAEDEL, Tuchklemme .....	030.8
Schlauchklemme.....	032.2
Schlauchklemme, BERLIN .....	032.3
Schlauchklemme, PRESBYTERIAN .....	032.3
Schlüssel für Approximator .....	026.6
Schwamm- und Tupferzange, ULRICH .....	030.12
Schwammzange, FOERSTER .....	030.11
Schwammzange, FOERSTER-BALLENGER.....	030.10
Schwammzange, RAMPLEY .....	030.11
Sinusklemme, LISTER.....	030.16
Sinusklemme, MARTIN .....	030.16

### T

Titan Bulldogklemme.....	026.15- 026.17
TOHOKU, Tuchklemme .....	030.6
Tuchklemme .....	030.7
Tuchklemme, BACKHAUS.....	030.4
Tuchklemme, BERNHARD.....	030.8
Tuchklemme, ENGL. MODELL .....	030.9
Tuchklemme, JONES .....	030.9
Tuchklemme, LANE .....	030.8
Tuchklemme, LORNA .....	030.6
Tuchklemme, PEERS.....	030.7
Tuchklemme, ROEDER.....	030.5
Tuchklemme, SCHAEDEL .....	030.8
Tuchklemme, TOHOKU .....	030.6
Tupfer- und Kornzange, BOZEMANN.....	030.15
Tupfer- und Kornzange, BOZEMANN-DOUGLAS.....	030.15
Tupfer- und Kornzange, BRYANT .....	030.15
Tupfer- und Kornzange, CHERON.....	030.14
Tupfer- und Kornzange, COLLIN .....	030.14
Tupfer- und Kornzange, GROSS-MAIER.....	030.13
Tupfer- und Schwammzange, ULRICH .....	030.12

### U

ULRICH, Schwamm- und Tupferzange.....	030.12
---------------------------------------	--------

### Z

Zange, Anlege-, JOHNS-HOPKINS.....	026.13
Zange, Schwamm-, FOERSTER .....	030.11
Zange, Schwamm-, FOERSTER-BALLENGER.....	030.10
Zange, Schwamm-, RAMPLEY .....	030.11

## Index, alphabetical

### A

applying forceps.....	026.2- 026.4
applying forceps, JOHNS-HOPKINS .....	026.13
approximator for nerves .....	026.6
approximator for nerves with key.....	026.6
approximator with key.....	026.6
approximator, BIEMER-MÜLLER .....	026.5
approximator, MÜLLER.....	026.4

### B

BACKHAUS, towel forceps .....	030.4
BERLIN, tubing clamp .....	032.3
BERNARD, towel forceps.....	030.8
BIEMER, vessel clip .....	026.3
BIEMER-MÜLLER approximator.....	026.5
BOZEMANN, cotton swap forceps .....	030.15
BOZEMANN-DOUGLAS, cotton swap forceps.....	030.15
BRYANT, cotton swap forceps .....	030.15
bulldog clamp, DE BAKEY .....	026.13
bulldog clamp, DE BAKEY DIETHRICH .....	026.10
bulldog clamp, DE BAKEY-SATINSKY .....	026.10, 026.11
bulldog clamp, DIEFFENBACH .....	026.7
bulldog clamp, DIETHRICH.....	026.9
bulldog clamp, GLOVER .....	026.11, 026.14
bulldog clamp, JOHNS-HOPKINS .....	026.8
bulldog clamp, SANTULLY .....	026.12
bulldog clamp, titan.....	026.15- 026.17

### C

carotid clamp, GREGORY .....	026.12
carotid clamp, GREGORY-SOFT.....	026.12
CHERON, cotton swap forceps .....	030.14
clamp, bulldog, DE BAKEY .....	026.13
clamp, bulldog, DE BAKEY DIETHRICH .....	026.10
clamp, bulldog, DE BAKEY-SATINSKY .....	026.10, 026.11
clamp, bulldog, DIEFFENBACH .....	026.7
clamp, bulldog, DIETHRICH.....	026.9
clamp, bulldog, GLOVER .....	026.11, 026.14
clamp, bulldog, JOHNS-HOPKINS .....	026.8
clamp, bulldog, SANTULLY .....	026.12
clamp, bulldog, titan.....	026.15- 026.17
clamp, carotid, GREGORY .....	026.12
clamp, carotid, GREGORY-SOFT.....	026.12
clamp, tubing.....	032.2
clamp, tubing, BERLIN .....	032.3
clamp, tubing, PRESBYTERIAN.....	032.3
clip vessel.....	026.2
COLLIN, cotton swap forceps.....	030.14
cotton swap forceps, BOZEMANN .....	030.15
cotton swap forceps, BOZEMANN-DOUGLAS.....	030.15
cotton swap forceps, BRYANT.....	030.15
cotton swap forceps, CHERON .....	030.14
cotton swap forceps, COLLIN.....	030.14
cotton swap forceps, GROSS-MAIER.....	030.13

### D

DE BAKEY DIETHRICH, bulldog clamp .....	026.10
DE BAKEY, bulldog clamp.....	026.13
DE BAKEY-SATINSKY, bulldog clamp.....	026.10, 026.11
DIEFFENBACH, bulldog clamp .....	026.7
DIETHRICH, bulldog clamp.....	026.9
dressing and sponge holding forceps, FOERSTER .....	030.11
dressing and sponge holding forceps, FOERSTER-BALLENGER .....	030.10
dressing and sponge holding forceps, RAMPLEY .....	030.11
dressing and sponge holding forceps, ULRICH.....	030.12

### E

ENGL. MODELL, towel forceps.....	030.9
----------------------------------	-------

### F

FOERSTER, dressing and sponge holding forceps .....	030.11
FOERSTER-BALLENGER, dressing and sponge holding forceps .....	030.10
forceps towel, BACKHAUS .....	030.4
forceps, applying.....	026.2- 026.4
forceps, applying, JOHNS-HOPKINS .....	026.13
forceps, cotton swap, BOZEMANN .....	030.15
forceps, cotton swap, BOZEMANN-DOUGLAS.....	030.15
forceps, cotton swap, BRYANT.....	030.15
forceps, cotton swap, CHERON .....	030.14
forceps, cotton swap, COLLIN.....	030.14
forceps, cotton swap, GROSS-MAIER.....	030.13
forceps, dressing and sponge holding, FOERSTER .....	030.11
forceps, dressing and sponge holding, FOERSTER-BALLENGER .....	030.10
forceps, dressing and sponge holding, RAMPLEY .....	030.11
forceps, dressing and sponge holding, ULRICH.....	030.12
forceps, towel.....	030.7
forceps, towel, BACKHAUS .....	030.4
forceps, towel, BERNARD.....	030.8
forceps, towel, ENGL. MODELL.....	030.9
forceps, towel, JONES .....	030.9
forceps, towel, LANE.....	030.8
forceps, towel, LORNA.....	030.6
forceps, towel, PEERS .....	030.7
forceps, towel, ROEDER .....	030.5
forceps, towel, SCHAEDEL .....	030.8
forceps, towel, TOHOKU.....	030.6

### G

GLOVER, bulldog clamp .....	026.11, 026.14
GREGORY, carotid clamp.....	026.12
GREGORY-SOFT, carotid clamp .....	026.12
GROSS-MAIER, cotton swap forceps.....	030.13

### J

JOHNS-HOPKINS, applying forceps .....	026.13
JOHNS-HOPKINS, bulldog clamp .....	026.8
JONES, towel forceps .....	030.9



## Index, alphabetical

### K

key for approximator .....026.6

### L

LANE, towel forceps.....030.8

LISTER, sinus forceps .....030.16

LORNA, towel forceps.....030.6

### M

MARTIN, sinus forceps.....030.16

MÜLLER approximator.....026.4

### P

PEERS, towel forceps .....030.7

PRESBYTERIAN, tubing clamp.....032.3

### R

RAMPLEY, dressing and sponge holding forceps.....030.11

ROEDER, towel forceps .....030.5

### S

SANTULLY, bulldog clamp .....026.12

SCHAEDEL, towel forceps .....030.8

sinus forceps, LISTER .....030.16

sinus forceps, MARTIN.....030.16

spare needles for approximator .....026.6

### T

titan bulldog clamp.....026.15- 026.17

TOHOKU , towel forceps.....030.6

towel forceps.....030.7

towel forceps, BACKHAUS .....030.4

towel forceps, BERNARD.....030.8

towel forceps, ENGL. MODELL.....030.9

towel forceps, JONES .....030.9

towel forceps, LANE.....030.8

towel forceps, LORNA.....030.6

towel forceps, ROEDER .....030.5

towel forceps, SCHAEDEL .....030.8

towel forceps, TOHOKU.....030.6

towel forcps, PEERS .....030.7

tubing clamp.....032.2

tubing clamp, BERLIN .....032.3

tubing clamp, PRESBYTERIAN.....032.3

### U

ULRICH, dressing and sponge holding forceps.....030.12

### V

vessel clip .....026.2

vessel clip, BIEMER .....026.3