

Klemmen
Clamps

040

Arterienklemmen
Haemostatic Forceps



Art.Nr.	Beschreibung Description	Size	Spez.
---------	----------------------------	------	-------

HARTMANN

10,0cm; 4"



040-000-10

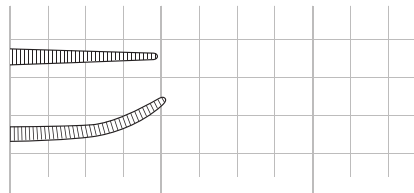

040-001-10

1/1 0 mm 20 mm 40 mm

040-010-08

CARREL

8,0cm; 3 1/8"

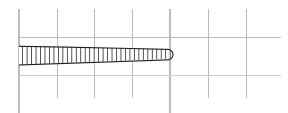

1/1 0 mm 20 mm

040-016-08

TERRIER

8,0cm; 3 1/8"



 1x2

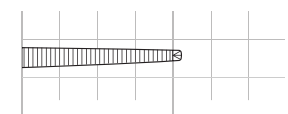

1/1 0 mm 20 mm

040

Art.Nr. Beschreibung | Description

MICRO-MOSQUITO



10,0cm; 4"

040-020-10

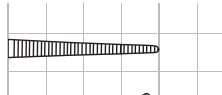

040-021-10



040-030-10



1x2

040-031-10



1x2

1/1 0 mm 20 mm

12,0cm; 4 3/4"

040-020-12



040-021-12

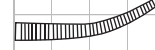

040-030-12



1x2

040-031-12

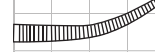

1x2

1/1 0 mm 20 mm

HALSTED-MOSQUITO



12,5cm; 5"

040-050-12



040-051-12



040-070-12



1x2

040-071-12

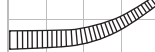

1x2

1/1 0 mm 20 mm

14,0cm; 5 1/2"

040-050-14

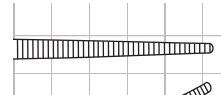

040-051-14



040-070-14



1x2

040-071-14

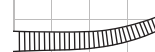

1x2

1/1 0 mm 20 mm

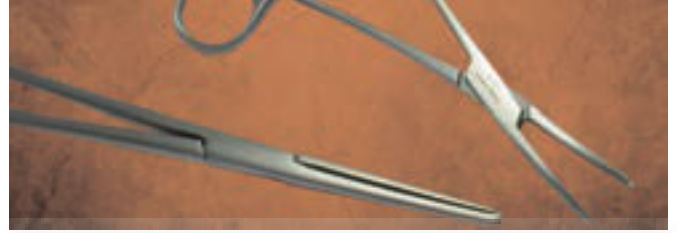

Art.Nr. Beschreibung | Description

HALSTED-MOSQUITO



040-050-18

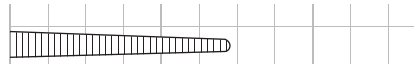

18,0cm; 7"

040-051-18

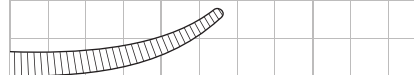

040-070-18

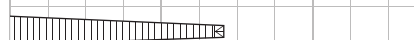

 1x2

040-071-18

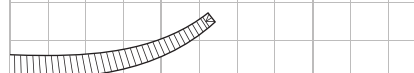

 1x2

040-050-21

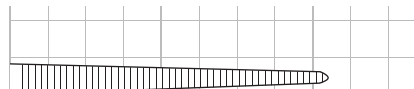

21,0cm; 8 1/4"

040-051-21

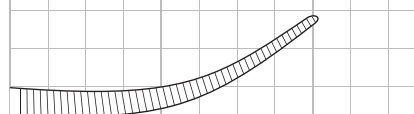

040-070-21

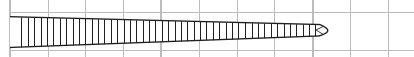

 1x2

040-071-21

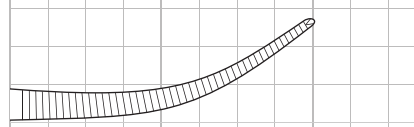

 1x2

1/1 0 mm 20 mm 40 mm

040

Art.Nr.	Beschreibung Description	Size	Spez.
	HALSTED-MOSQUITO TITAN	12,0cm; 4 3/4"	Ti

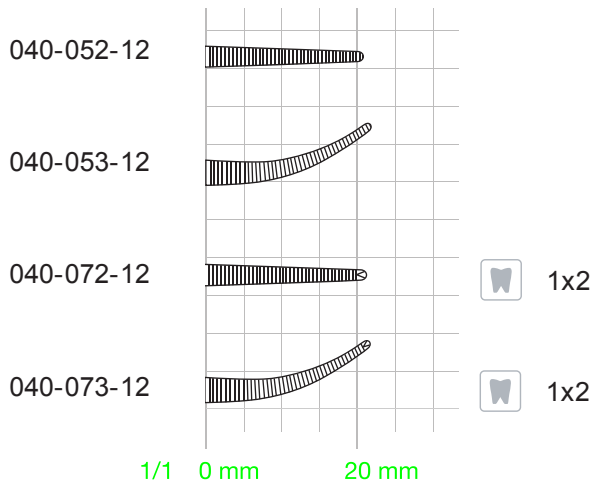

TITAN

- extremely light weight
- corrosion-resistant
- high tensile strenght

Arterienklemmen
Haemostatic Forceps



Art.Nr.	Beschreibung Description	Size	Spez.
	PROVIDENCE-HOSPITAL	14,0cm; 5 1/2"	

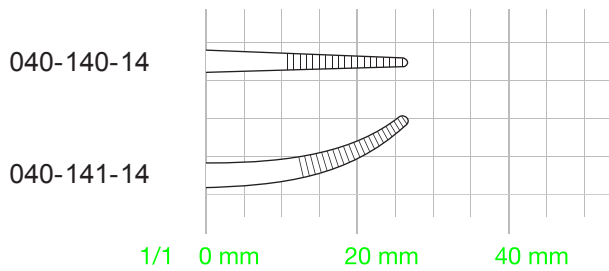

	KELLY	14,0cm; 5 1/2"	
--	-------	----------------	--

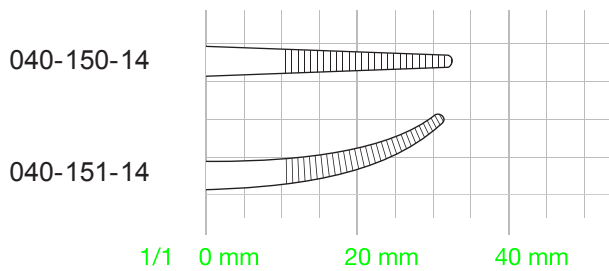

040

Arterienklemmen
Haemostatic Forceps

Art.Nr.	Beschreibung Description	Size	Spez.
	KELLY-RANKIN	16,0cm; 6 1/4"	

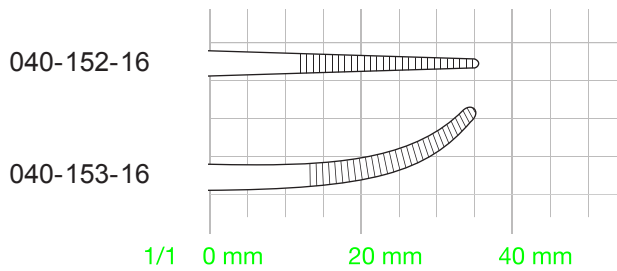

KELLY TITAN

14,0cm; 5 1/2"

Ti

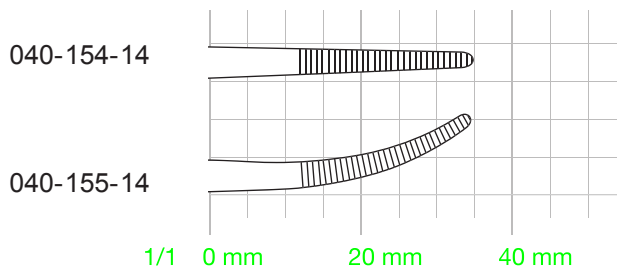
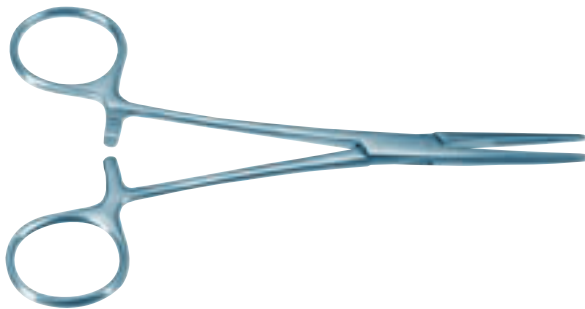

Arterienklemmen
Haemostatic Forceps



Art.Nr. Beschreibung | Description Size Spez.

CRILE

14,0cm; 5 1/2"



040-160-14

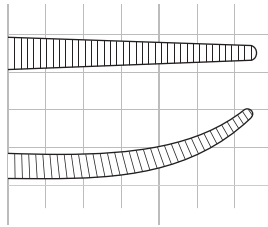

1/1 0 mm 20 mm

040-170-14

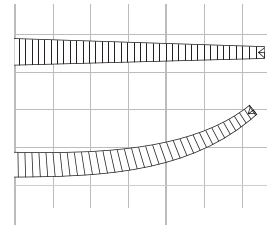

1/1 0 mm 20 mm

 1x2

040-161-14

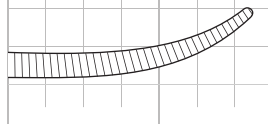

040-171-14

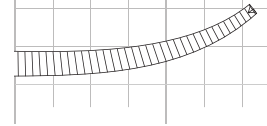

1/1 0 mm 20 mm

 1x2

040-341-12

DANDY-MOSQUITO

12,0cm; 4 3/4"

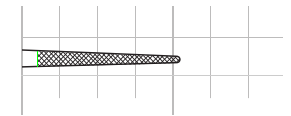
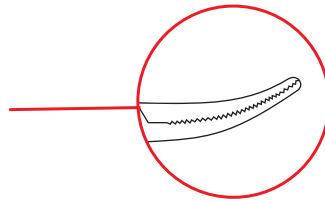

1/1 0 mm 20 mm

CRILE TITAN

14,0cm; 5 1/2"

Ti

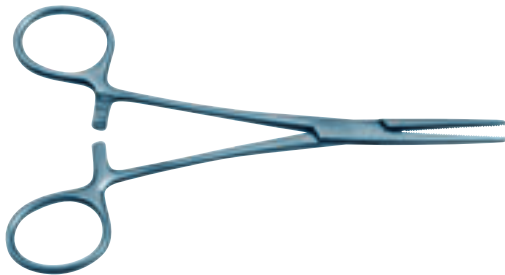

040-162-14

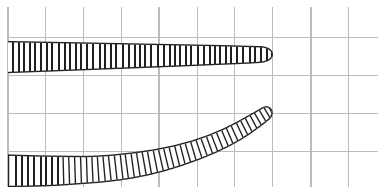

1/1 0 mm 20 mm 40 mm

040-163-14

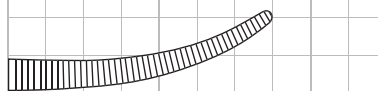

1/1 0 mm 20 mm 40 mm

040

Arterienklemmen
Haemostatic Forceps

Art.Nr.	Beschreibung Description	Size	Spez.
---------	----------------------------	------	-------

DANDY

14,0cm; 5 1/2"

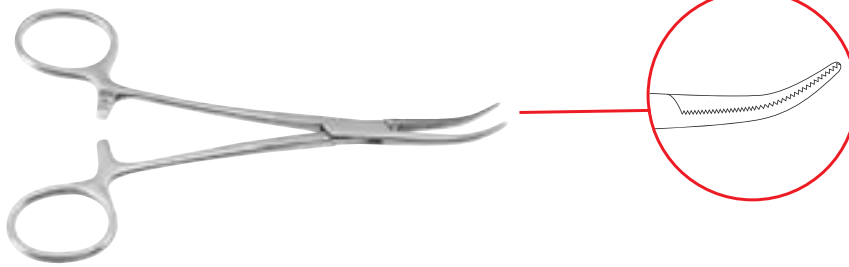

040-345-14

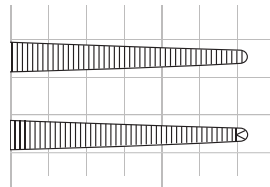

040-347-14



 1x2

1/1 0 mm 20 mm

LERICHE

15,0cm; 6"



040-380-15

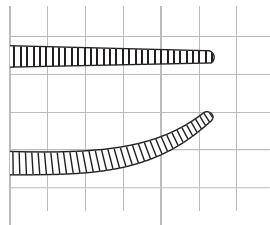

040-381-15

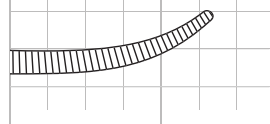

1/1 0 mm 20 mm

040-382-15

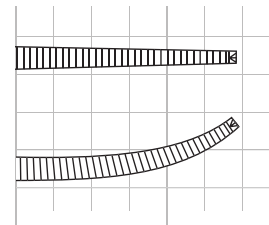

 1x2

040-383-15

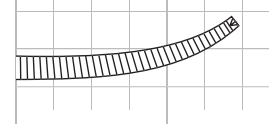

 1x2

1/1 0 mm 20 mm

Arterienklemmen
Haemostatic Forceps



Art.Nr.	Beschreibung Description	Size	Spez.
---------	----------------------------	------	-------

CRILE-RANKIN

16,0cm; 6 1/4"



040-180-16

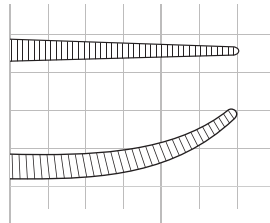

1/1 0 mm 20 mm

040-182-16

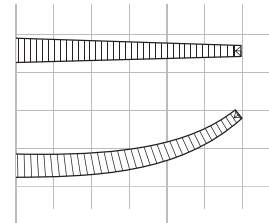

1/1 0 mm 20 mm

1x2

040-181-16

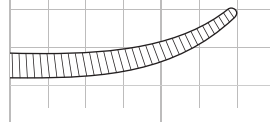

1/1 0 mm 20 mm

040-183-16

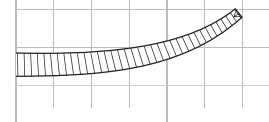

1/1 0 mm 20 mm

1x2

PEAN



040-368-14

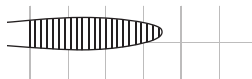

14,0cm; 5 1/2"

040-368-16

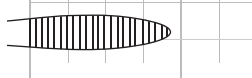

16,0cm; 6 1/4"

1/1 0 mm 20 mm

040-369-13

KROENLEIN

13,0cm; 5 1/8"

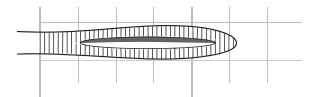

1/1 0 mm 20 mm

040

Art.Nr. Beschreibung | Description

SPENCER-WELLS



040-290-13		13,0cm; 5 1/8"
040-290-14		14,0cm; 5 1/2"
040-290-15		15,0cm; 6"
040-290-18		18,0cm; 7"
040-290-20		20,0cm; 8"
040-291-13		13,0cm; 5 1/8"
040-291-14		14,0cm; 5 1/2"
040-291-15		15,0cm; 6"
040-291-18		18,0cm; 7"
040-291-20		20,0cm; 8"

1/1 0 mm 20 mm 40 mm

Arterienklemmen
Haemostatic Forceps

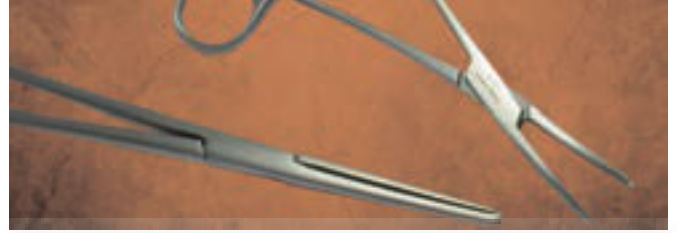

Art.Nr. Beschreibung | Description

PEAN DELICATE



040-262-13		13,0cm; 5 1/8"
040-262-14		14,0cm; 5 1/2"
040-262-16		16,0cm; 6 1/4"
040-263-13		13,0cm; 5 1/8"
040-263-14		14,0cm; 5 1/2"
040-263-16		16,0cm; 6 1/4"

1/1 0 mm 20 mm 40 mm 60 mm

040

Art.Nr. Beschreibung | Description

PEAN-NIPPON



040-404-14		14,5cm; 5 3/4"
040-404-16		16,5cm; 6 1/2"
040-404-18		18,5cm; 7 1/4"
040-405-14		14,5cm; 5 3/4"
040-405-16		16,5cm; 6 1/2"
040-405-18		18,5cm; 7 1/4"





1/1 0 mm 20 mm 40 mm 60 mm

Arterienklemmen
Haemostatic Forceps



Art.Nr.	Beschreibung Description	Spez.
	KOCHER DELICATE	 1x2

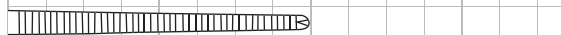

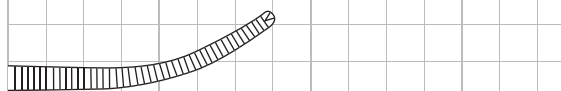
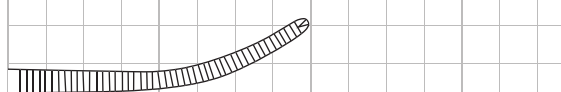
040-352-13		13,0cm; 5 1/8"
040-352-14		14,0cm; 5 1/2"
040-352-16		16,0cm; 6 1/4"
040-353-13		13,0cm; 5 1/8"
040-353-14		14,0cm; 5 1/2"
040-353-16		16,0cm; 6 1/4"

1/1 0 mm 20 mm 40 mm 60 mm

040

Art.Nr.	Beschreibung Description	Spez.
	KOCHER-NIPPON	 1x2

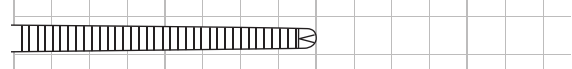
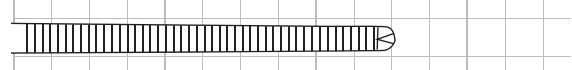
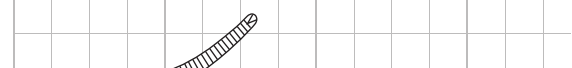
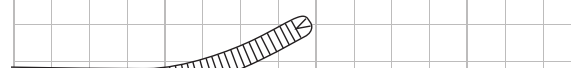
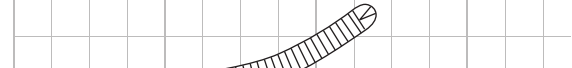

040-406-14		14,5cm; 5 3/4"
040-406-16		16,5cm; 6 1/2"
040-406-18		18,5cm; 7 1/4"
040-407-14		14,5cm; 5 3/4"
040-407-16		16,5cm; 6 1/2"
040-407-18		18,5cm; 7 1/4"

1/1 0 mm 20 mm 40 mm 60 mm

Arterienklemmen
Haemostatic Forceps



Art.Nr.	Beschreibung Description	Size	Spez.
---------	----------------------------	------	-------

ROCHESTER-PEAN

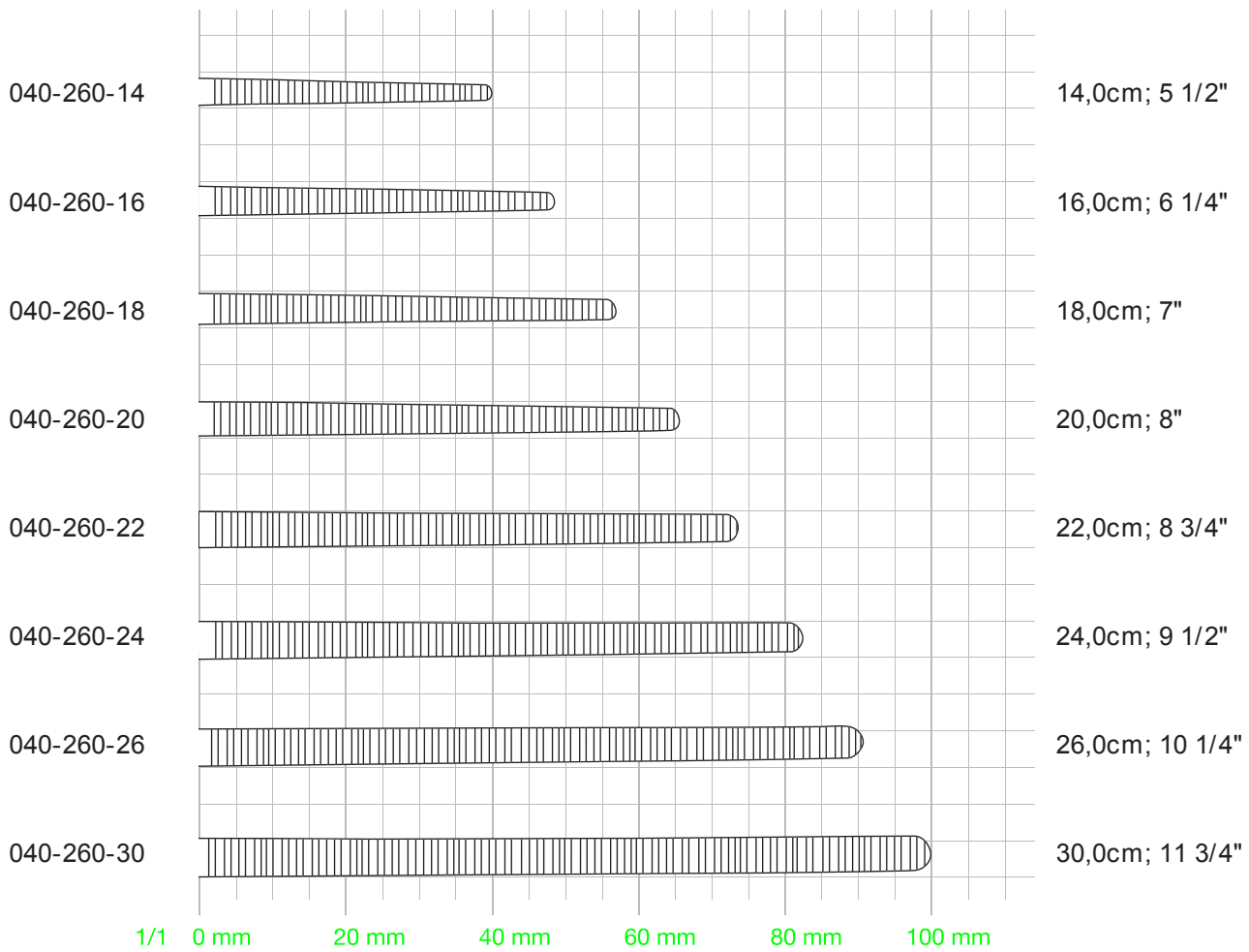

040

Art.Nr. Beschreibung | Description Size Spez.

ROCHESTER-PEAN

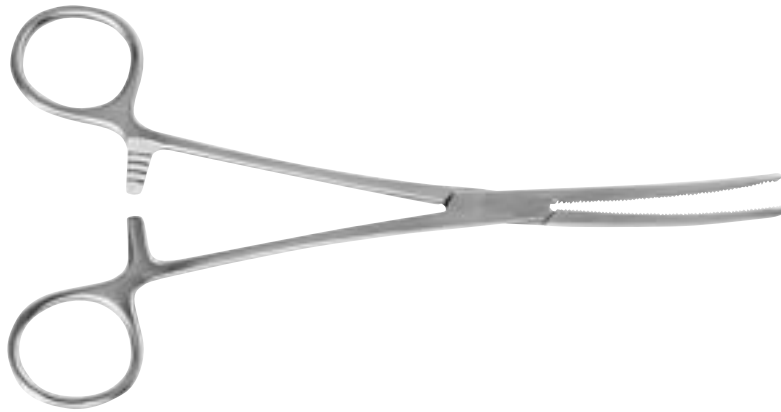

040-261-14		14,0cm; 5 1/2"
040-261-16		16,0cm; 6 1/4"
040-261-18		18,0cm; 7"
040-261-20		20,0cm; 8"
040-261-22		22,0cm; 8 3/4"
040-261-24		24,0cm; 9 1/2"
040-261-26		26,0cm; 10 1/4"
040-261-30		30,0cm; 11 3/4"





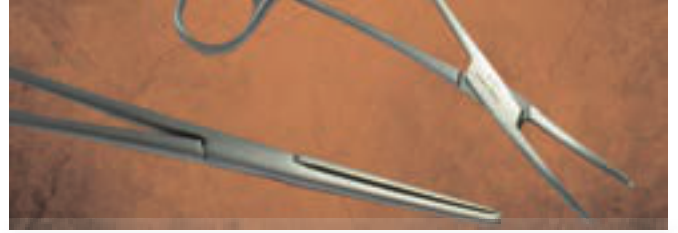

1/1 0 mm 20 mm 40 mm 60 mm 80 mm 100 mm

Arterienklemmen
Haemostatic Forceps

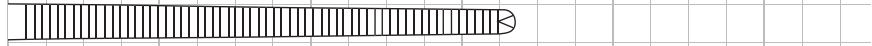

Art.Nr.	Beschreibung Description	Size	Spez.
	KOCHER-OCHSNER		 1x2



040-350-14		14,0cm; 5 1/2"
040-350-16		16,0cm; 6 1/4"
040-350-18		18,0cm; 7"
040-350-20		20,0cm; 8"
040-350-22		22,0cm; 8 3/4"
040-350-24		24,0cm; 9 1/2"
040-350-26		26,0cm; 10 1/4"
040-350-30		30,0cm; 11 3/4"

1/1 0 mm 20 mm 40 mm 60 mm 80 mm 100 mm

040

Art.Nr.	Beschreibung Description	Size	Spez.
	KOCHER-OCHSNER		 1x2

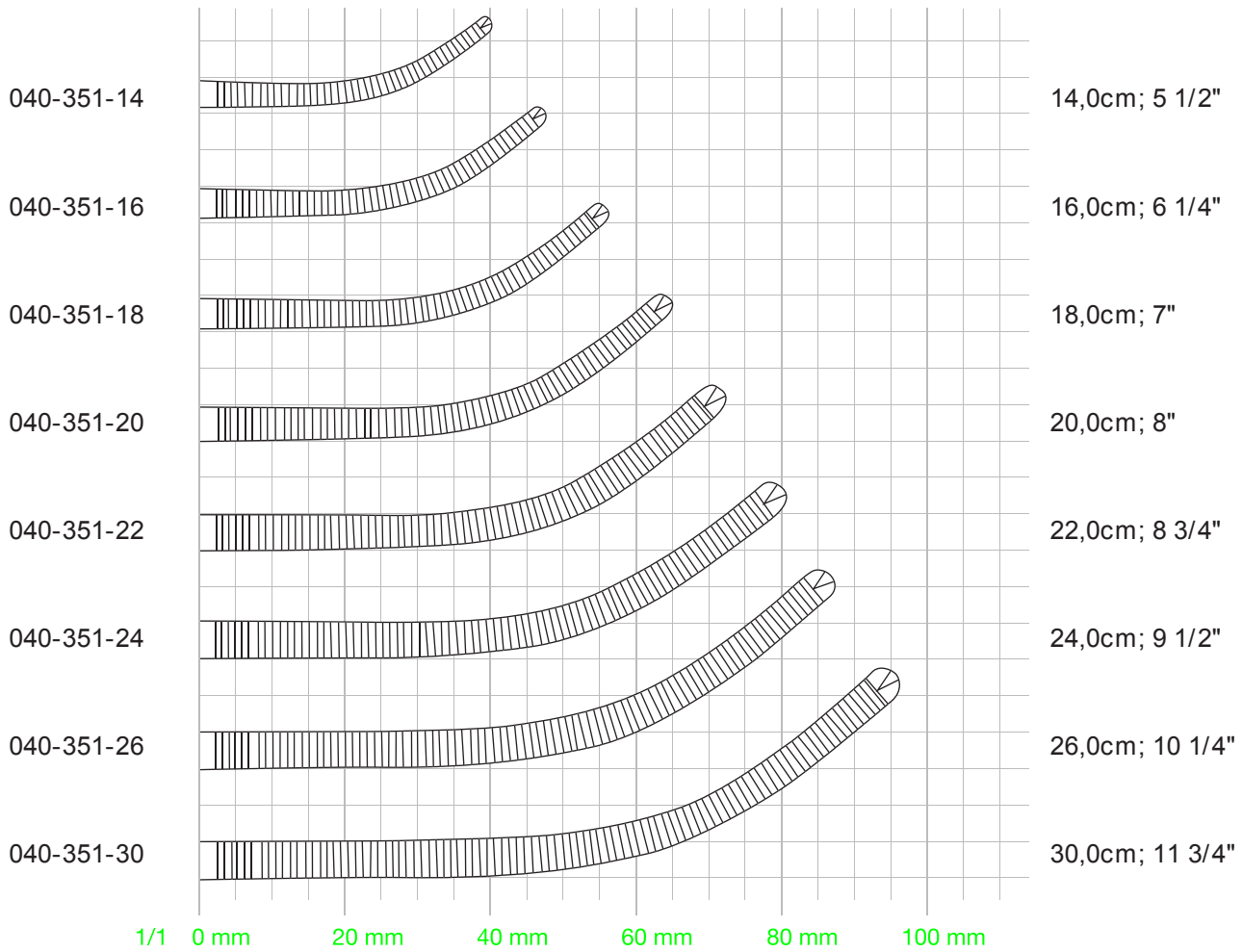
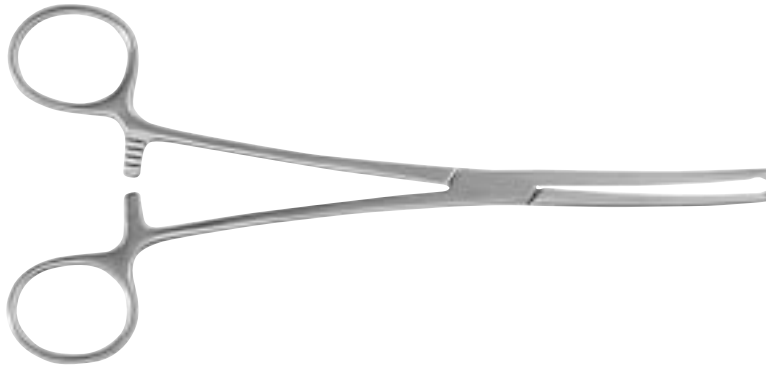

Gewebefäßzangen
Tissue Grasping Forceps

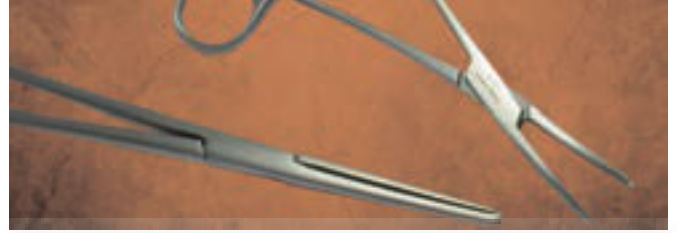

Art.Nr.	Beschreibung Description	Size	Spez.
040-370-13	CHAPUT	13,0cm; 5 1/8"	



040-372-13	TUFFIER	13,0cm; 5 1/8"	
------------	---------	----------------	--

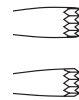

040-362-14	COLLIN	14,0cm; 5 1/2"	
------------	--------	----------------	--

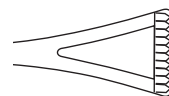

040

Gewebefäßzangen
Tissue Grasping Forceps

Art.Nr.	Beschreibung Description	Size	Spez.
---------	----------------------------	------	-------

PENNINGTON

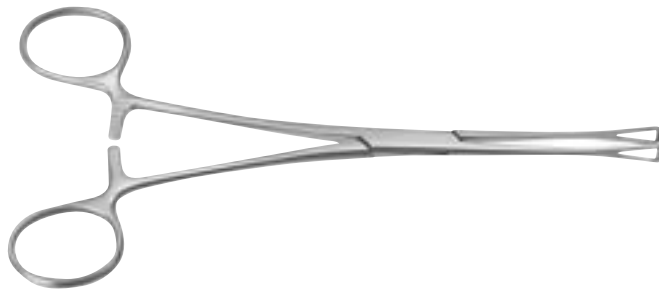

040-358-15

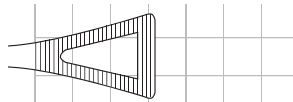

15,0cm; 6"

040-358-20

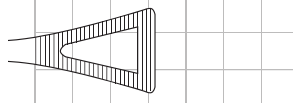

20,0cm; 8"

1/1 0 mm 20 mm

040-376-16

COLLIN

16,0cm; 6 1/4"

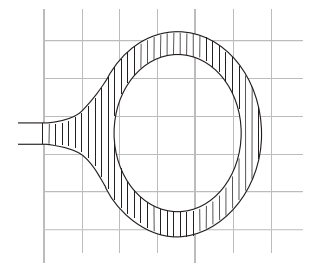
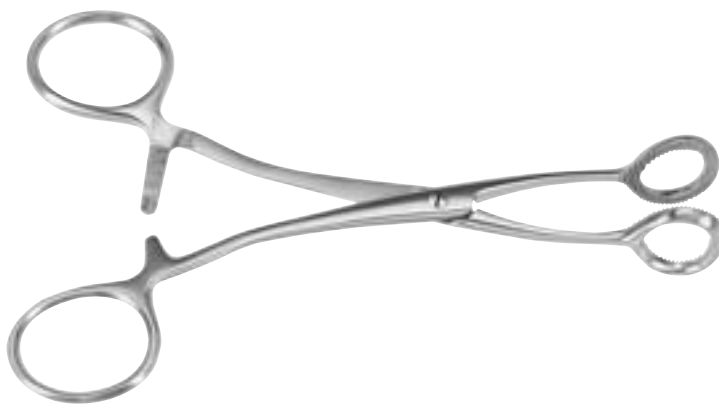

1/1 0 mm 20 mm

040

Arterienklemmen
Haemostatic Forceps



Art.Nr.	Beschreibung Description	Size	Spez.
---------	----------------------------	------	-------

ROCHESTER-CARMALT



040-340-16



16,0cm; 6 1/4"

040-341-16

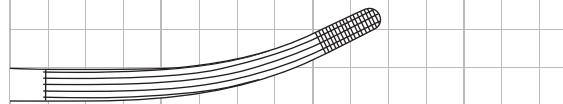

16,0cm; 6 1/4"

040-340-20



20,0cm; 8"

040-341-20

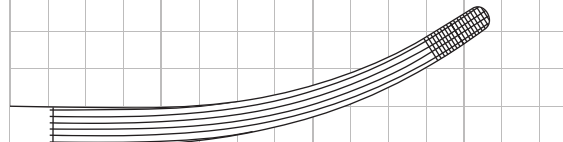

20,0cm; 8"

1/1 0 mm 20 mm 40 mm 60 mm

DIXON-LOVELACE

15,0cm; 6"



040-354-15

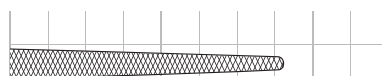

040-356-15



 1x2

1/1 0 mm 20 mm 40 mm

040

Art.Nr.	Beschreibung Description	Size	Spez.
---------	----------------------------	------	-------

BABY-ADSON



040-411-14

14,0cm; 5 1/2"

040-411-18

18,0cm; 7"

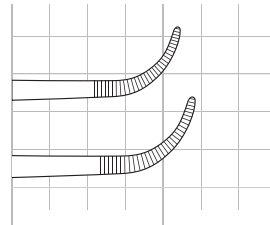

1/1 0 mm 20 mm

ADSON

18,5cm; 7 1/4"

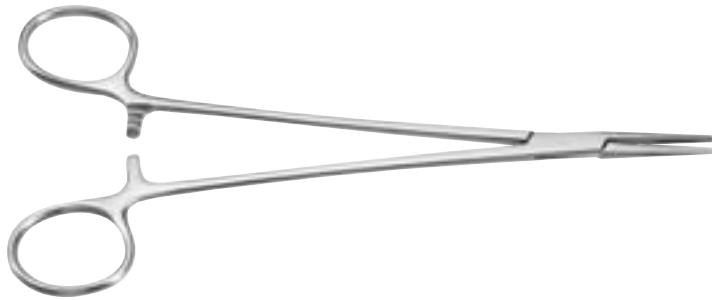

040-414-18

040-415-18

040-412-18

040-413-18

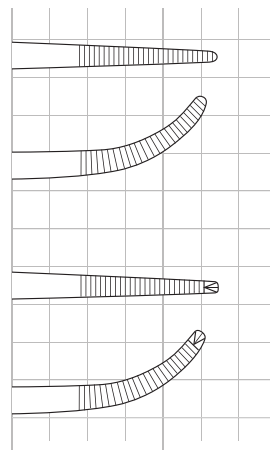

 1x2

 1x2

1/1 0 mm 20 mm

Arterienklemmen
Haemostatic Forceps



Art.Nr.	Beschreibung Description	Size	Spez.
---------	----------------------------	------	-------

HEISS

20,0cm, 8"



040-390-20

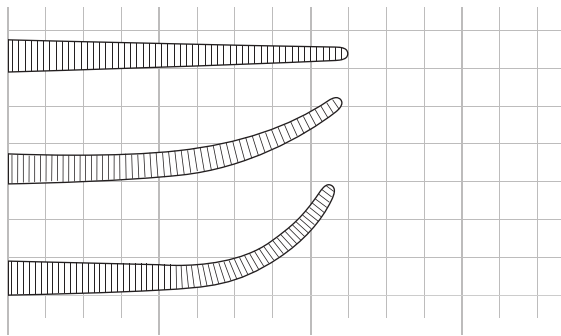

040-391-20

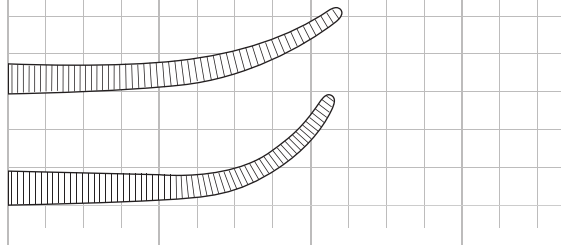

040-393-20

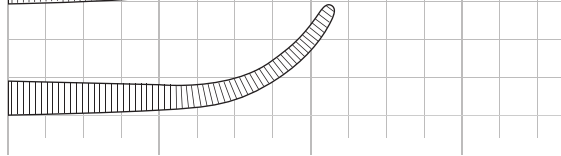

1/1 0 mm 20 mm 40 mm 60 mm

040-419-20

FUCHSIG

20,5cm; 8"

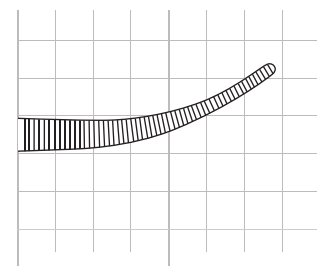

1/1 0 mm 20 mm

040

Art.Nr. Beschreibung | Description Size Spez.

BENGOLEA



040-384-20		20,0cm; 8"	
040-385-20			
040-386-20			1x2
040-387-20			1x2

040-384-26		26,0cm; 10 1/4"	
040-385-26			
040-386-26			1x2
040-387-26			1x2

1/1 0 mm 20 mm 40 mm

Arterienklemmen
Haemostatic Forceps

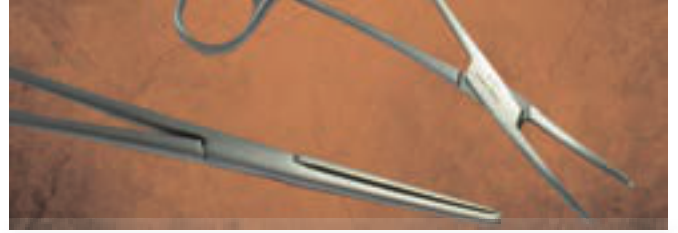

Art.Nr.	Beschreibung Description	Size	Spez.
---------	----------------------------	------	-------

CRAFOORD



040-453-18

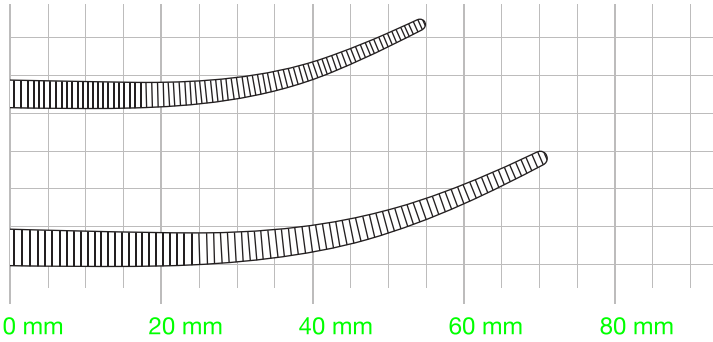

18,0cm; 7"

040-453-24

24,0cm; 9 1/2"

1/1 0 mm 20 mm 40 mm 60 mm 80 mm

SAROT

24,0cm; 9 1/2"



040-450-24

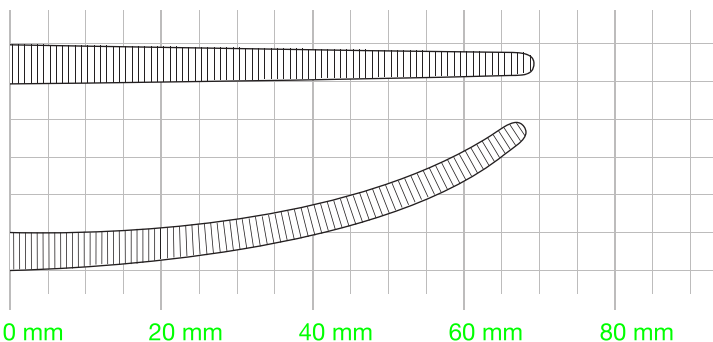

040-451-24

1/1 0 mm 20 mm 40 mm 60 mm 80 mm

040

Art.Nr.	Beschreibung Description	Size	Spez.
---------	----------------------------	------	-------

BIRKETT

19,0cm; 7 1/2"



040-540-19

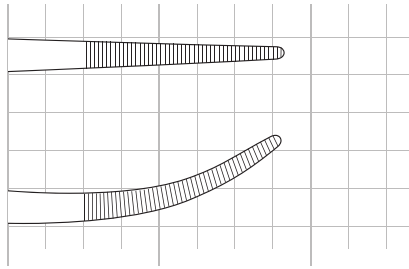

040-541-19

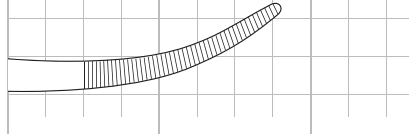

1/1 0 mm 20 mm 40 mm

NEGUS

19,0cm; 7 1/2"



040-533-01

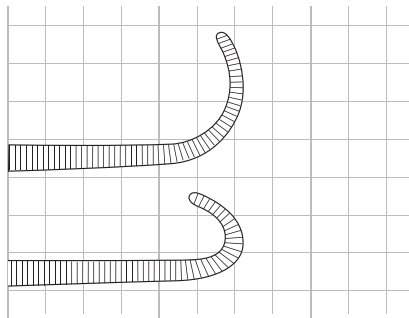

040-533-02

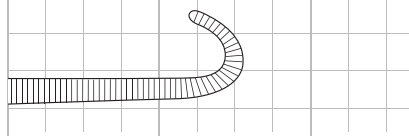

1/1 0 mm 20 mm 40 mm

Arterienklemmen
Haemostatic Forceps

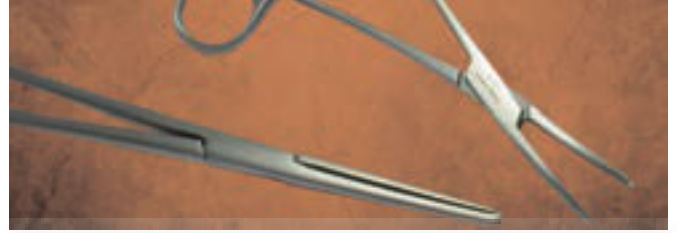

Art.Nr.	Beschreibung Description	Size	Spez.
	ROBERTS	22,0cm; 8 3/4"	

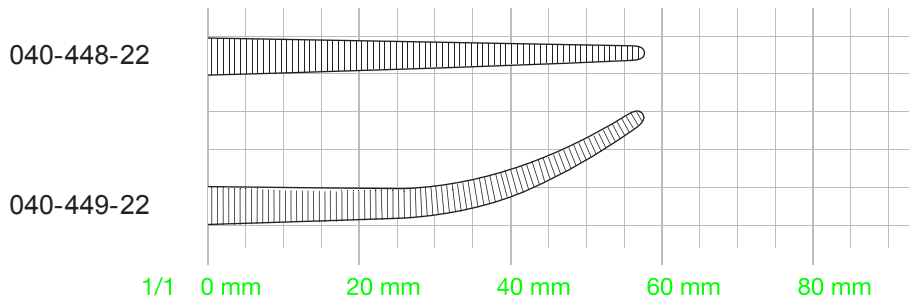

We can help to find a specific product. If you do not find a product in this catalogue please send us the reference catalogue number or an illustration of the instrument you are looking for.



Art.Nr. Beschreibung | Description

OVERHOLT

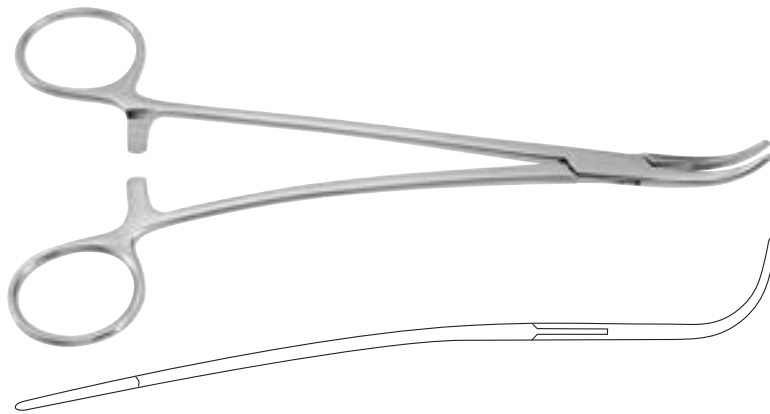

040-423-01		18,5cm; 7 1/4"
040-423-02		20,5cm; 8"
040-423-03		21,0cm; 8 1/4"
040-423-04		21,5cm; 8 1/2"
040-423-05		24,0cm; 9,6"

1/1 0 mm 20 mm 40 mm 60 mm

Präparierklemmen
Dissecting and Ligature Forceps



Art.Nr. Beschreibung | Description

OVERHOLT-FINO



040-426-00		21,5cm; 8 1/2"
040-426-01		21,0cm; 8 1/4"
040-426-02		22,0cm; 8 3/4"
040-426-03		23,0cm; 9"
040-426-06		22,5cm; 9"

1/1 0 mm 20 mm 40 mm

040

Präparierklemmen
Dissecting and Ligature Forceps

Art.Nr. Beschreibung | Description Size Spez.

OVERHOLT

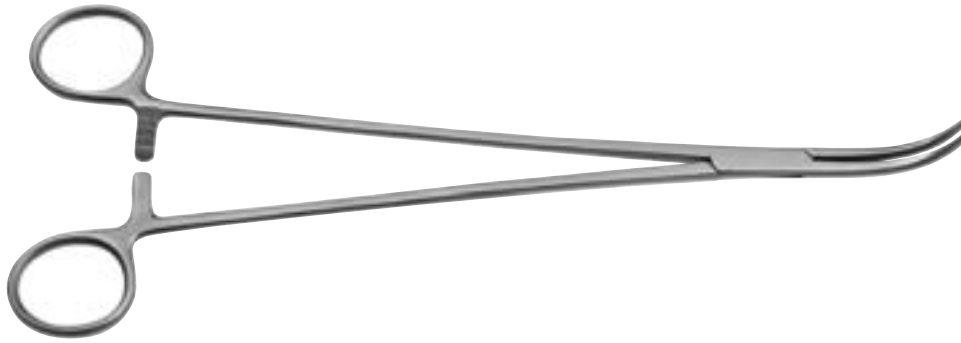

040-427-00

29,5cm; 11 1/2"

040-427-01

29,5cm; 11 1/2"

040-427-03

30,0cm; 11 3/4"

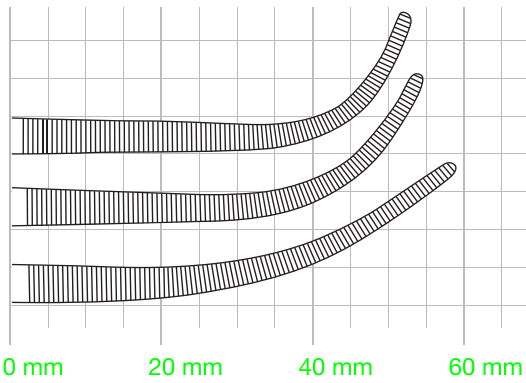

040-428-01

OVERHOLT-MINI

15,0cm; 6"

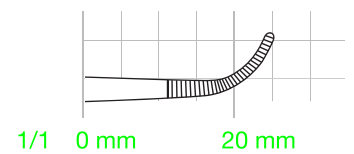

040-428-02

OVERHOLT-MINI

20,0cm; 8"

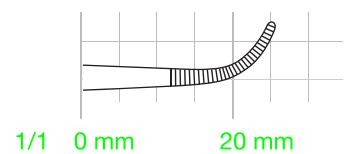

Präparierklemmen
Dissecting and Ligature Forceps



Art.Nr.	Beschreibung Description	Size	Spez.
040-424-14	OVERHOLT-BABY	13,5cm; 5 1/4"	

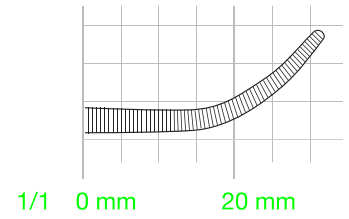

040-471-21	OVERHOLT-MIXTER	21,0cm; 8 1/4"	
------------	-----------------	----------------	--

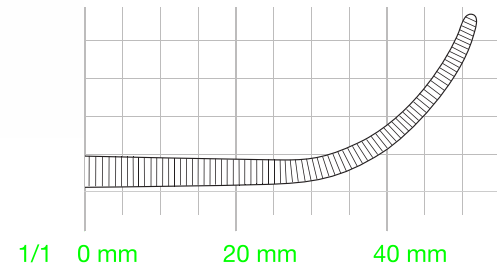

Präparierklemmen
Dissecting and Ligature Forceps

Art.Nr.	Beschreibung Description	Size	Spez.
	RUMEL	23,0cm; 9"	

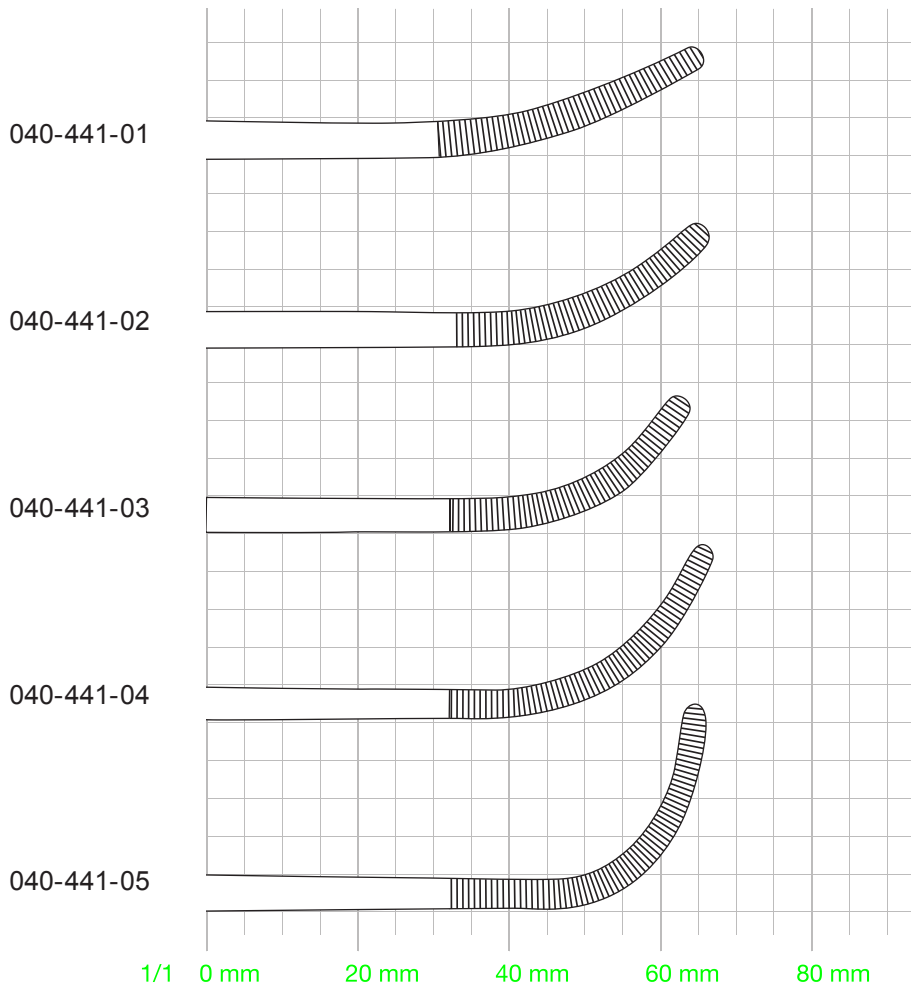

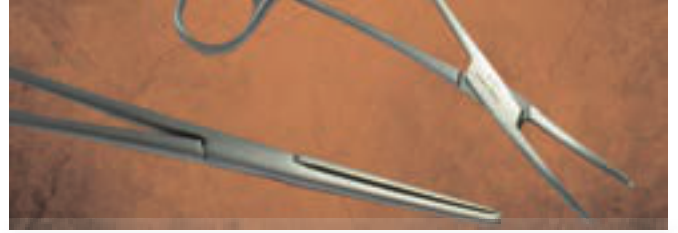

Art.Nr. Beschreibung | Description

OVERHOLT-GEISSENDOERFER



040-421-01	Fig. 1	19,5cm; 7 3/4"
040-421-02	Fig. 2	19,0cm; 7 1/2"
040-421-03	Fig. 3	21,0cm; 8 1/4"
040-421-04	Fig. 4	22,0cm; 8 3/4"
040-421-05	Fig. 5	21,5cm; 8 1/2"
040-421-06	Fig. 6	22,0cm; 8 3/4"
040-421-07	Fig. 7	22,0cm; 8 3/4"

1/1 0 mm 20 mm 40 mm

Art.Nr. Beschreibung | Description

OVERHOLT-GEISSENDOERFER



040-422-01	Fig. 1	27,0cm; 10 3/4"
040-422-02	Fig. 2	26,0cm; 10 1/4"
040-422-03	Fig. 3	27,0cm; 10 3/4"
040-422-04	Fig. 4	27,5cm; 10 3/4"
040-422-05	Fig. 5	27,0cm; 10 3/4"
040-422-06	Fig. 6	28,0cm; 11"
040-422-07	Fig. 7	28,0cm; 11"

1/1 0 mm 20 mm 40 mm

Präparierklemmen
Dissecting and Ligature Forceps



Art.Nr.	Beschreibung Description	Size	Spez.
---------	----------------------------	------	-------

WIKSTROEM

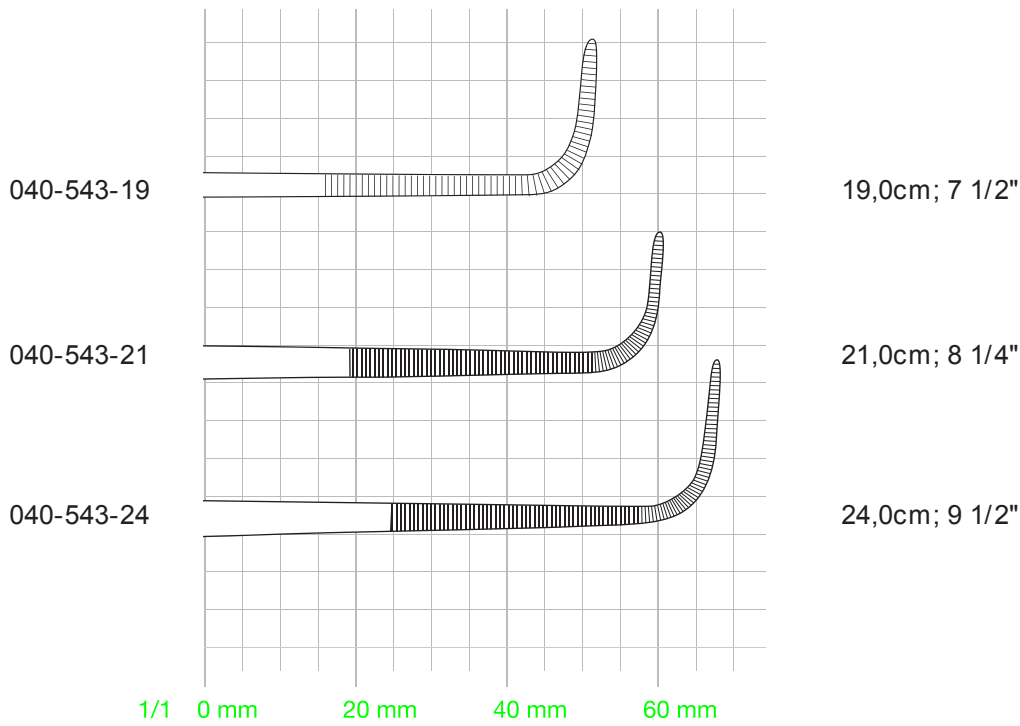

040

Präparierklemmen
Dissecting and Ligature Forceps

Art.Nr.	Beschreibung Description	Size	Spez.
---------	----------------------------	------	-------

MINI-GEMINI





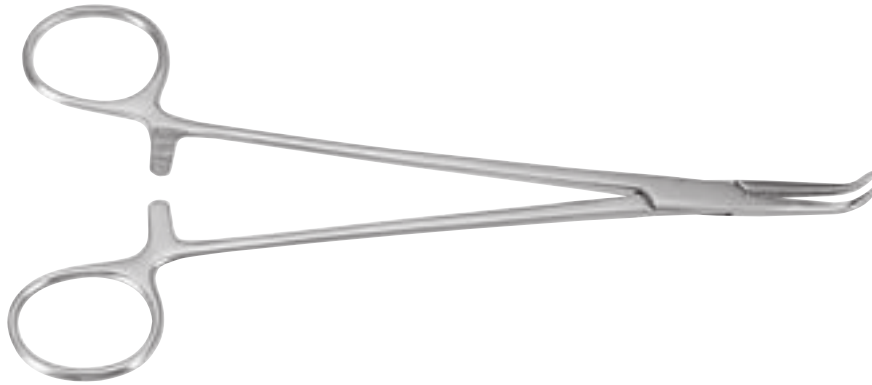

Art.Nr. Beschreibung | Description

GEMINI

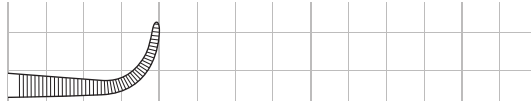
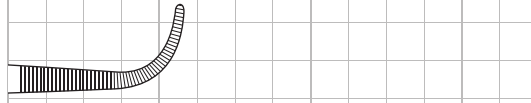

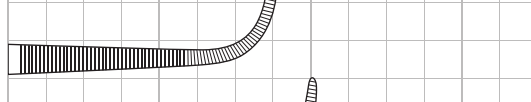
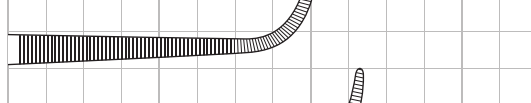
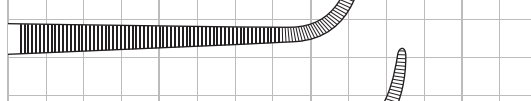
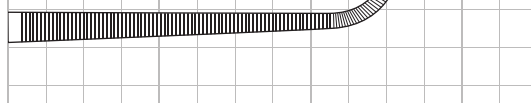
040-431-14		14,0cm; 5 1/2"
040-431-16		16,0cm; 6 1/4"
040-431-18		18,0cm; 7"
040-431-20		20,0cm; 8"
040-431-23		23,0cm; 9"
040-431-25		25,0cm; 9 3/4"
040-431-28		28,0cm; 11"

1/1 0 mm 20 mm 40 mm 60 mm

040

Präparierklemmen
Dissecting and Ligature Forceps

Art.Nr.	Beschreibung Description	Size	Spez.
040-475-18	BABY-MIXTER	18,0cm; 7"	

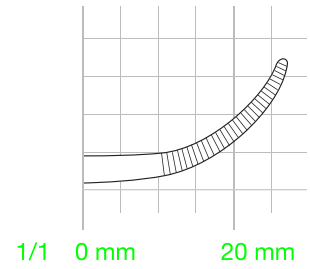

040-497-20	JOHNS HOPKINS	20,0cm; 8"	
------------	---------------	------------	--

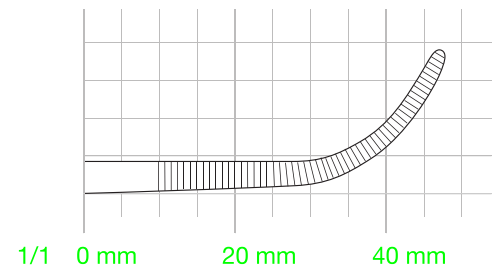
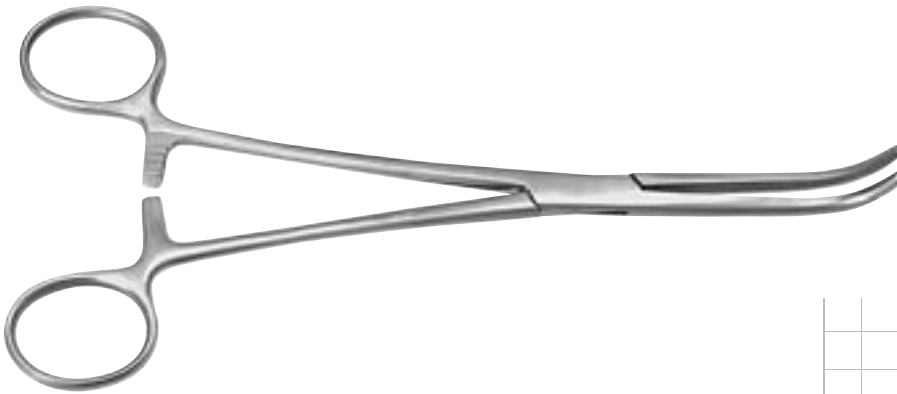

Präparierklemmen
Dissecting and Ligature Forceps



Art.Nr. Beschreibung | Description

MIXTER



040-461-15

15,5cm; 6 1/8"

040-461-19

19,0cm; 7 1/2"

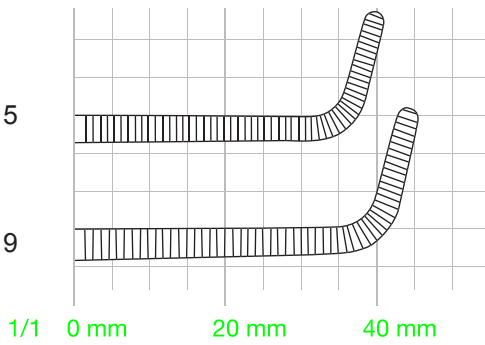

MIXTER-O'SHAUGNESSY



040-477-15

15,5cm; 6 1/8"

040-477-19

19,0cm; 7 1/2"

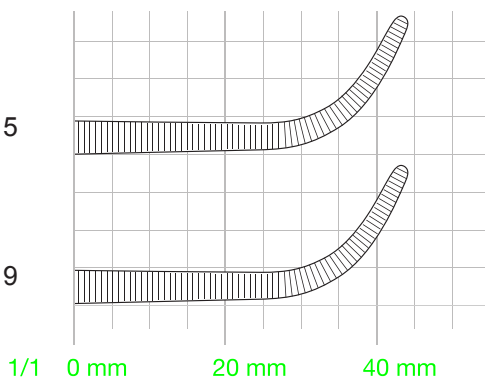

040

Präparierklemmen
Dissecting and Ligature Forceps

Art.Nr.	Beschreibung Description	Size	Spez.
---------	----------------------------	------	-------

BABY-MIXTER

14,0cm; 5 1/2"



040-475-01

040-475-02

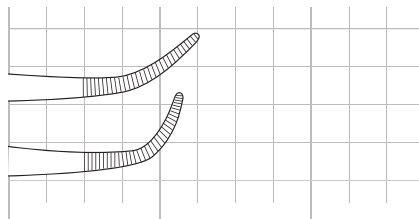

1/1 0 mm 20 mm 40 mm

040-473-22

MIXTER

22,0cm; 8 3/4"

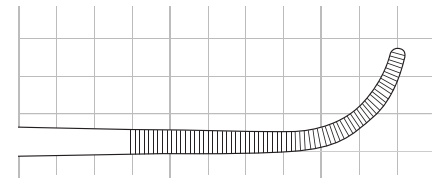

1/1 0 mm 20 mm 40 mm

040-473-23

MIXTER

23,0cm; 9"

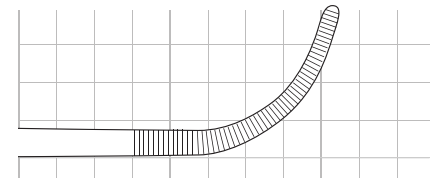

1/1 0 mm 20 mm 40 mm

040

Präparierklemmen
Dissecting and Ligature Forceps

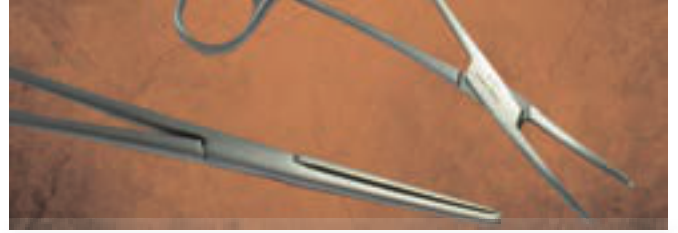

Art.Nr.	Beschreibung Description	Size	Spez.
---------	----------------------------	------	-------

KELLY



040-463-19	Fig. 1		19,0cm; 7 1/2"
040-465-19	Fig. 2		
040-467-19	Fig. 3		
040-463-22	Fig. 1		22,0cm; 8 3/4"
040-465-22	Fig. 2		
040-467-22	Fig. 3		
040-463-24	Fig. 1		24,0cm; 9 1/2"
040-465-24	Fig. 2		
040-467-24	Fig. 3		

1/1 0 mm 20 mm 40 mm 60 mm

040

Präparierklemmen
Dissecting and Ligature Forceps

Art.Nr.	Beschreibung Description	Size	Spez.
	ZENKER	29,5cm; 11 1/2"	



040-455-01

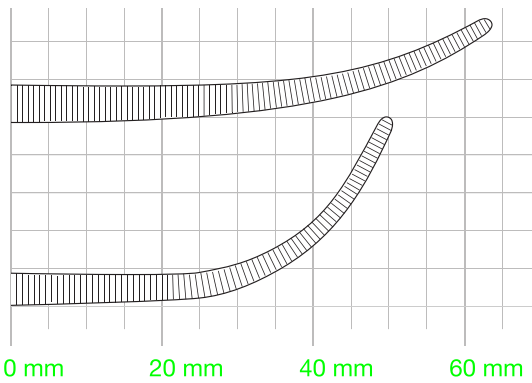

040-455-02

1/1 0 mm 20 mm 40 mm 60 mm

MEEKER

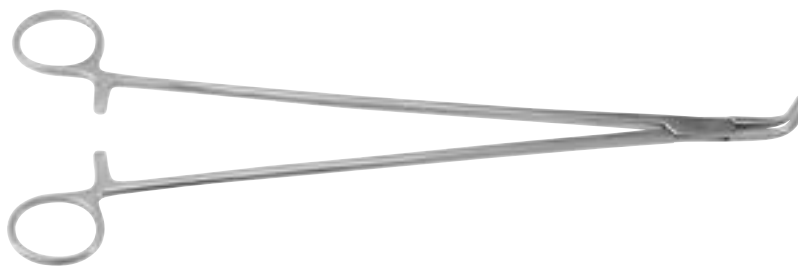

040-459-18

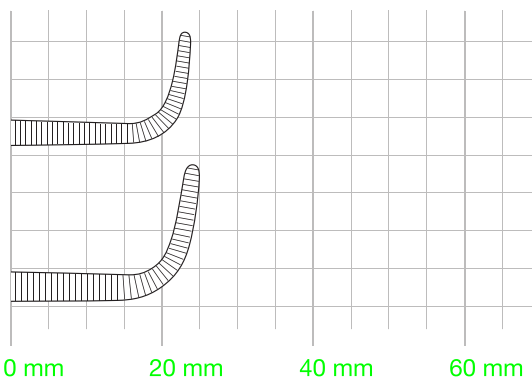

18,0cm; 7"

040-459-28

1/1 0 mm 20 mm 40 mm 60 mm

27,5cm; 10 3/4"

Präparierklemmen; Gallenkanalklemmen
 Dissecting and Ligature Forceps; Bile Duct Clamps



Art.Nr.	Beschreibung Description	Size	Spez.
---------	----------------------------	------	-------

040-457-28	LAWRENCE	27,5cm; 10 3/4"	
------------	----------	-----------------	--

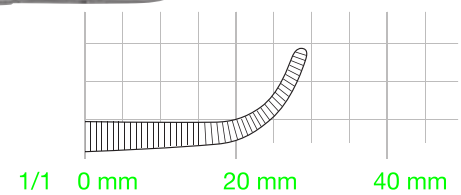
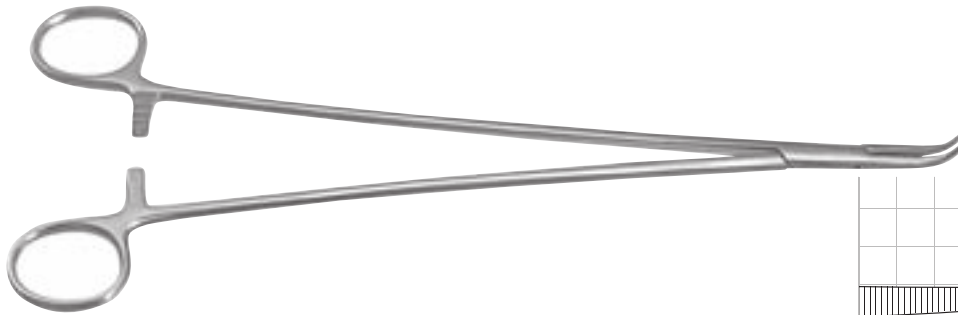

040-529-21	DESJARDINS	21,0cm; 8 1/4"	
------------	------------	----------------	--

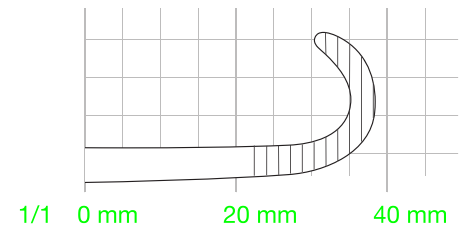

LAHEY

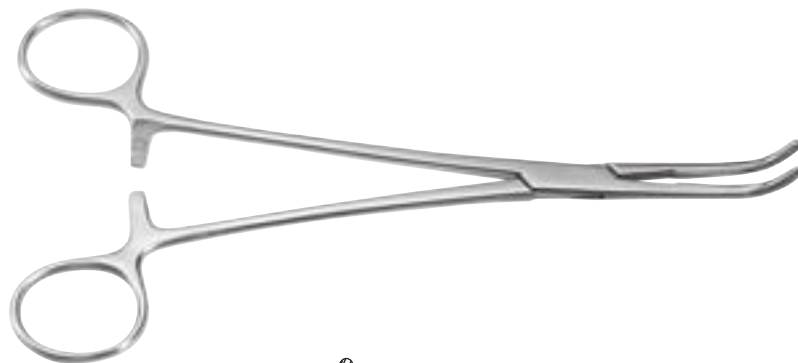

040-501-19		19,0cm; 7 1/2"	
------------	--	----------------	--

040-501-23		23,0cm; 9"	
------------	--	------------	--

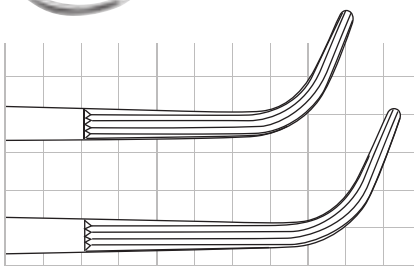

040

Präparierklemmen
Dissecting and Ligature Forceps

Art.Nr.	Beschreibung Description	Size	Spez.
---------	----------------------------	------	-------

MIXTER

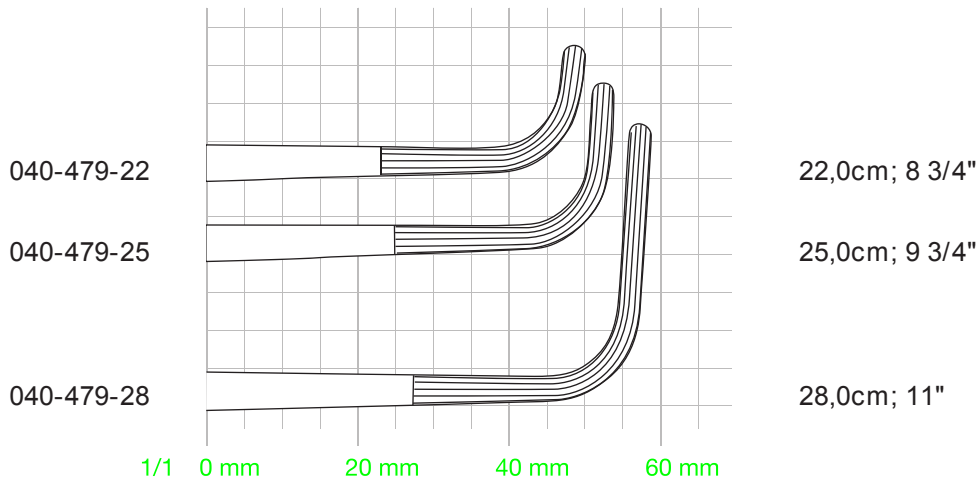

040-503-18	LOWER	18,0cm; 7"
------------	-------	------------

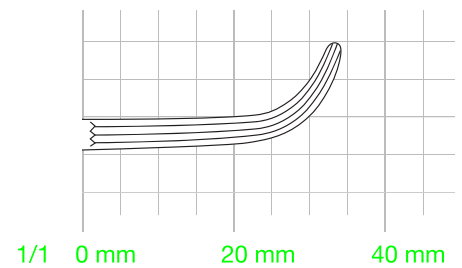

Präparierklemmen
Dissecting and Ligature Forceps



Art.Nr.	Beschreibung Description	Size	Spez.
040-505-24	FINOCCHIETTO	24,0cm; 9 1/2"	

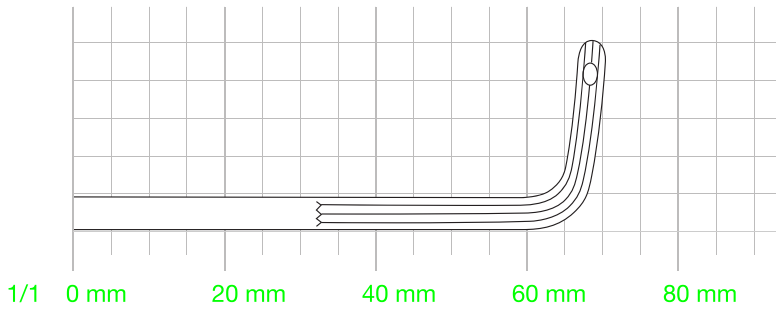

Arterienklemmen; Gallenkanalklemmen
Haemostatic Forceps; Bile Duct Clamps

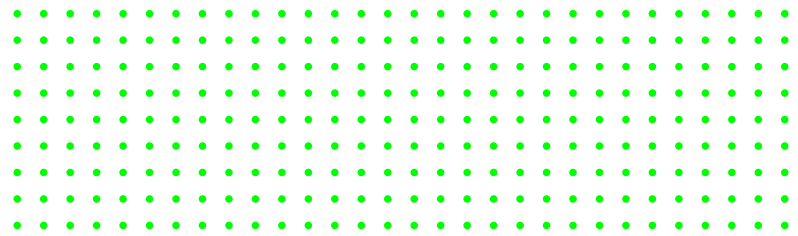

Art.Nr. Beschreibung | Description

GRAY

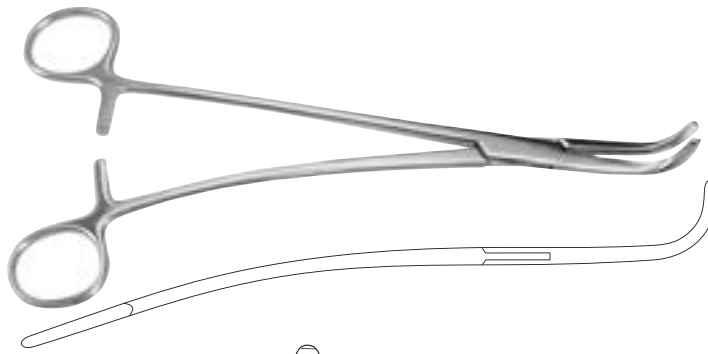

040-523-22		22,0cm; 8 3/4"
040-523-23		23,0cm; 9"
040-525-22		22,0cm; 8 3/4"
040-525-23		23,0cm; 9"

1/1 0 mm 20 mm 40 mm

1x2

CRAFOORD-SELLORS

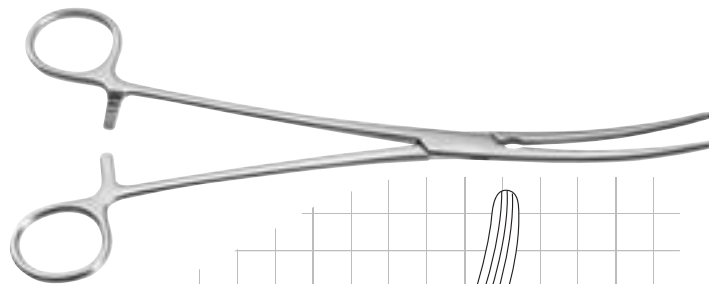

040-456-22		22,0cm; 8 3/4"
040-456-23		23,0cm; 9"
040-456-24		24,0cm; 9 1/2"

1/1 0 mm 20 mm 40 mm 60 mm 80 mm

Nierenstielklemmen
Kidney Pedicle Clamps



Art.Nr.	Beschreibung Description	Size	Spez.
---------	----------------------------	------	-------

GUYON



040-509-20

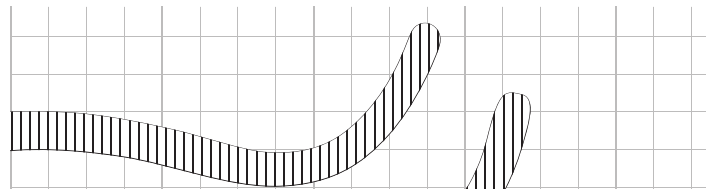

20,0cm; 8"

040-509-22

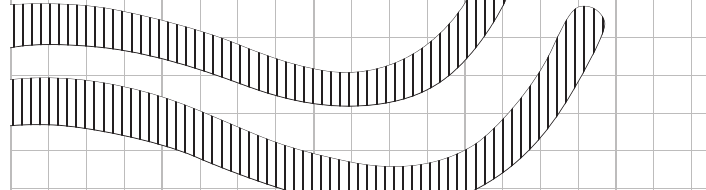

22,0cm; 8 3/4"

040-509-24

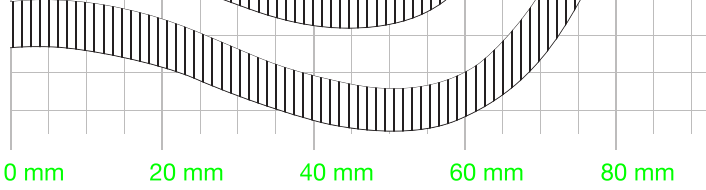

24,0cm; 9 1/2"

1/1 0 mm 20 mm 40 mm 60 mm 80 mm

040-513-23

GUYON

23,0cm; 9"

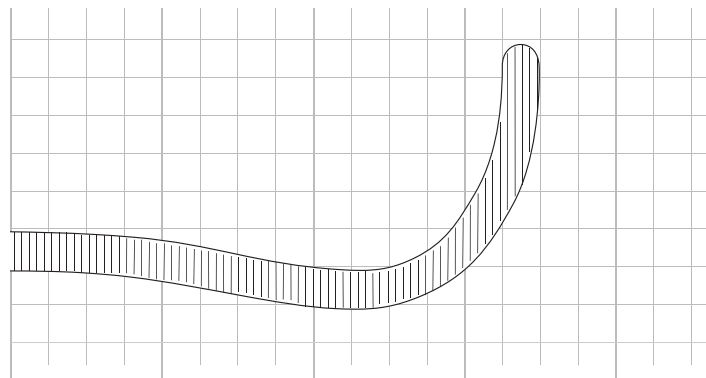

1/1 0 mm 20 mm 40 mm 60 mm 80 mm

040

Nierenstielklemmen
Kidney Pedicle Clamps

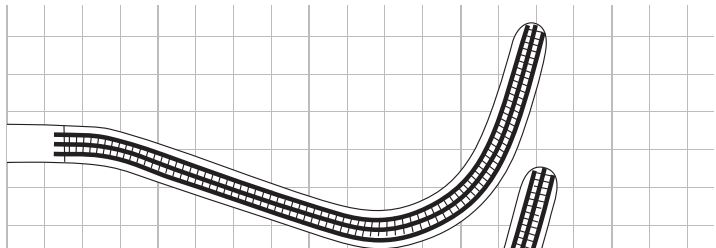
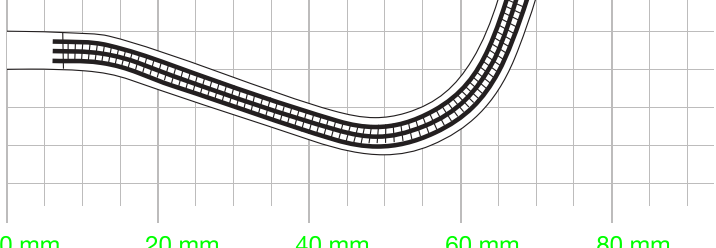
Art.Nr.	Beschreibung Description	Size	Spez.
	<p>GUYON</p> 		<div style="border: 1px solid black; padding: 2px; display: inline-block;"> ATRAUMA </div>
040-519-23		23,0cm; 9"	
040-519-24		24,0cm; 9 1/2"	
1/1	0 mm 20 mm 40 mm 60 mm 80 mm		

Organfasszangen
Organ Grasping Forceps

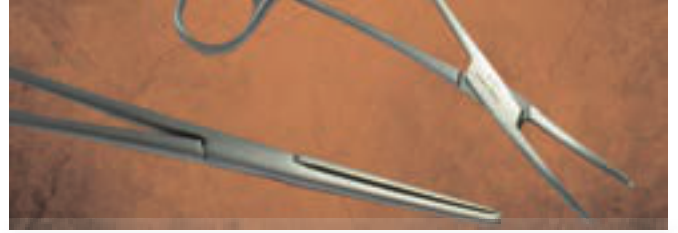

Art.Nr.	Beschreibung Description	Size	Spez.
---------	----------------------------	------	-------



ATRAUMA

040-658-25

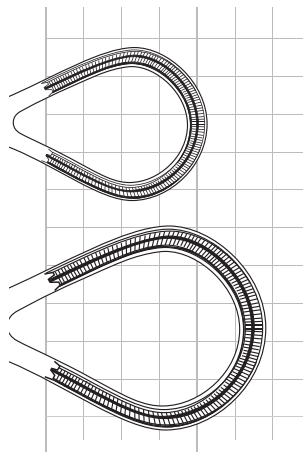

25,0cm; 9 3/4"

040-658-27

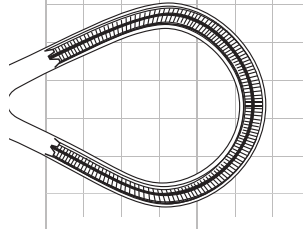

27,0cm; 10 3/4"

1/1 0 mm 20 mm

040-656-15

PRATT

15,0cm; 6"

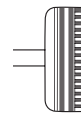

040

Kopfhautklemmen; Arterienklemmen
Scalp flap forceps; Haemostatic Forceps

Art.Nr.	Beschreibung Description	Size	Spez.
---------	----------------------------	------	-------

040-364-14

MARTEL

14,0cm; 5 1/2"

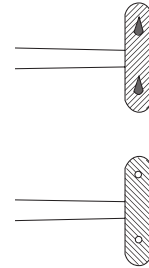

040-366-19

WILLET-MARTEL

19,0cm; 7 1/2"

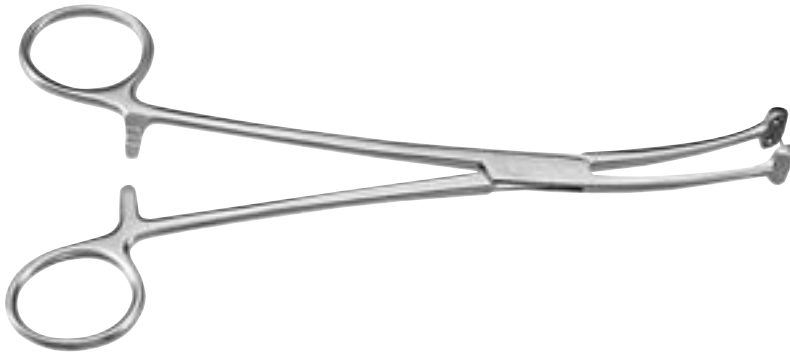

FERGUSSON



040-650-16

16,0cm; 6 1/4"

040-650-20

20,0cm; 8"

040-651-16

16,0cm; 6 1/4"

040-651-20

20,0cm; 8"

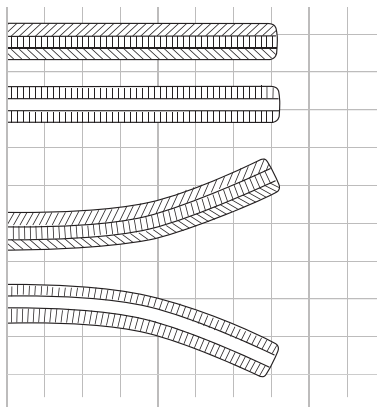



1/1 0 mm 20 mm 40 mm

Peritoneumklemmen
Peritoneum Forceps

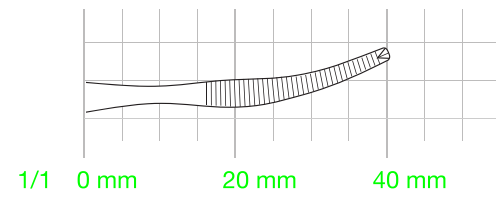

Art.Nr.	Beschreibung Description	Size	Spez.
040-701-14	BABY-MIKULICZ	14,0cm; 5 1/2"	 1x2



040-703-18	MIKULICZ	18,0cm; 7"	 1x2
------------	----------	------------	---

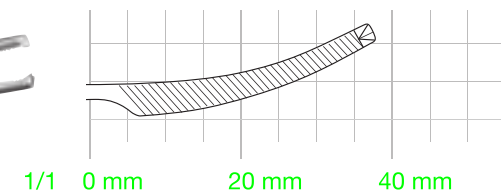

Peritoneumklemmen
Peritoneum Forceps

Art.Nr.	Beschreibung Description	Size	Spez.
040-709-20	MIKULICZ	20,0cm; 8"	 1x2

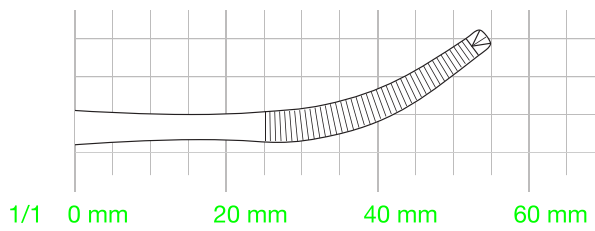

FAURE

20,0cm; 8"

 1x2

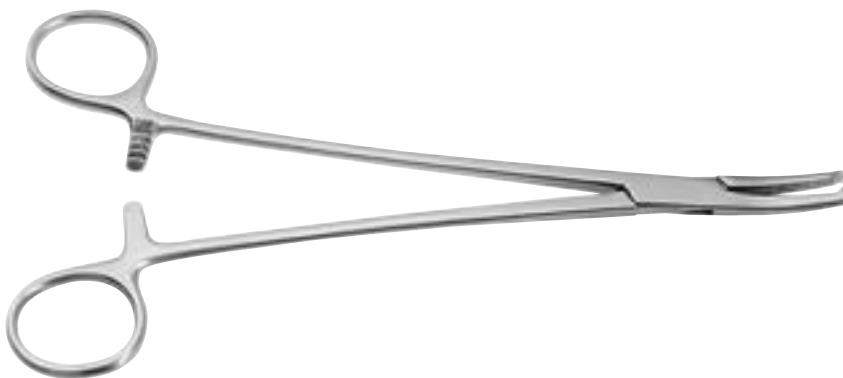

040-721-20

040-723-20

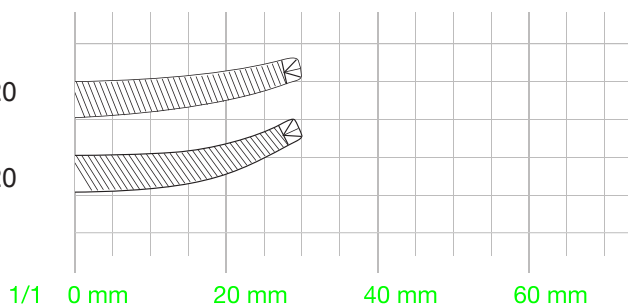

Hysterektomieklemmen
Hysterectomy Forceps



Art.Nr.	Beschreibung Description	Size	Spez.
	PHANEUF	21,5cm; 8 1/2"	 1x2



040-630-21



040-631-21

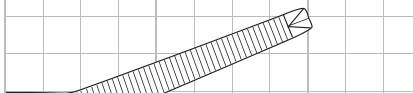

1/1 0 mm 20 mm 40 mm

040-602-25	WERTHEIM	25,0cm; 10"
------------	----------	-------------

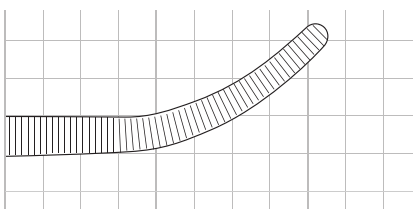
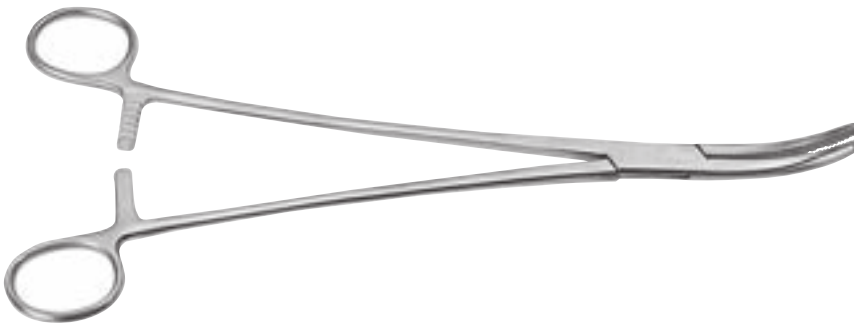

1/1 0 mm 20 mm 40 mm

040

Hysterektomieklemmen
Hysterectomy Forceps

Art.Nr.	Beschreibung Description	Size	Spez.
	WERTHEIM	23,0cm; 9"	 1x2

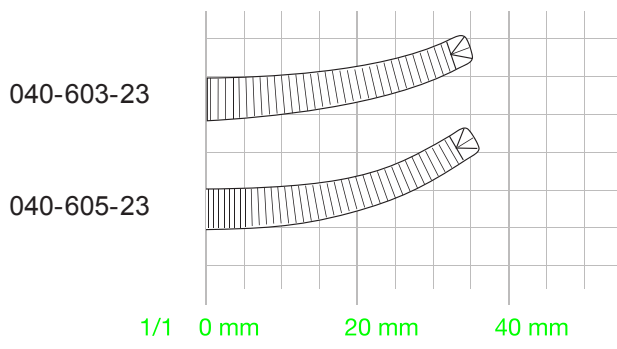
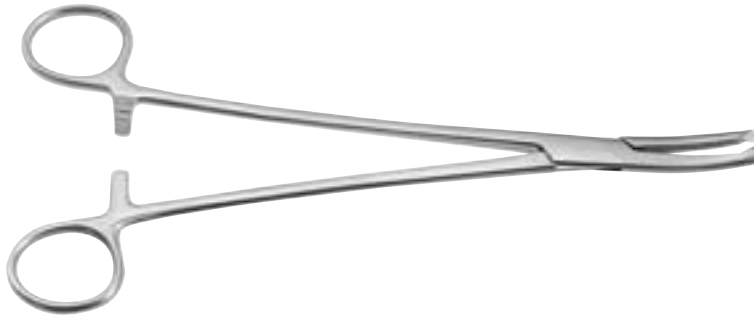

MOYNIHAN

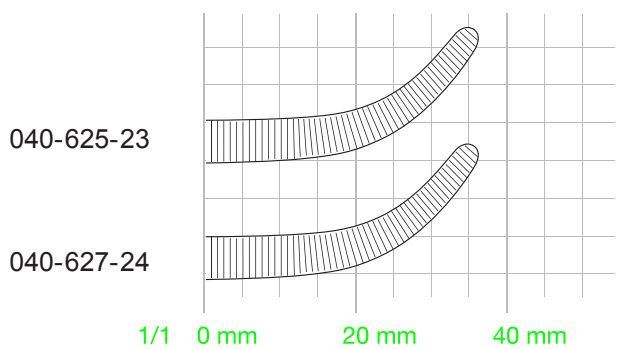
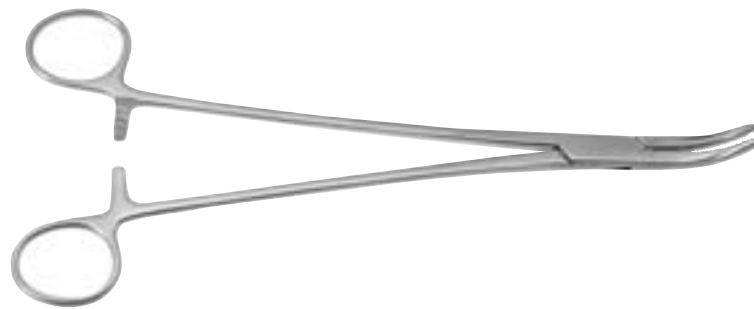

23,0cm; 9"

24,0cm; 9 1/2"

Hysterektomieklappen
Hysterectomy Forceps



Art.Nr. Beschreibung | Description

ROGERS

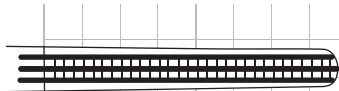
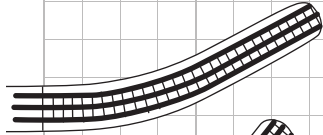
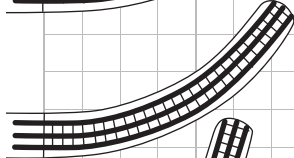
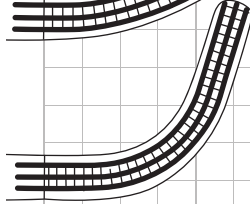
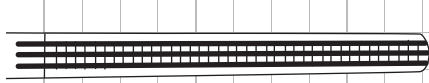
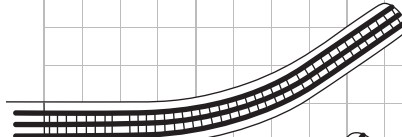
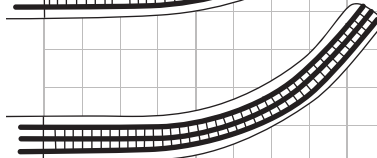

040-580-21	Fig. 1		21,5cm; 8 1/2"
040-581-21	Fig. 2		21,0cm; 8 1/4"
040-583-21	Fig. 3		20,5cm; 8"
040-585-21	Fig. 4		20,0cm; 8"
040-580-24	Fig. 1		25,5cm; 10"
040-581-24	Fig. 2		25,0cm; 9 3/4"
040-583-24	Fig. 3		24,5cm; 8 2/3"

1/1 0 mm 20 mm 40 mm 60 mm

040

Hysterektomieklemmen
Hysterectomy Forceps

Art.Nr.	Beschreibung Description	Size	Spez.
040-629-21	WERTHEIM-CULLEN	21,5cm; 8 1/2"	

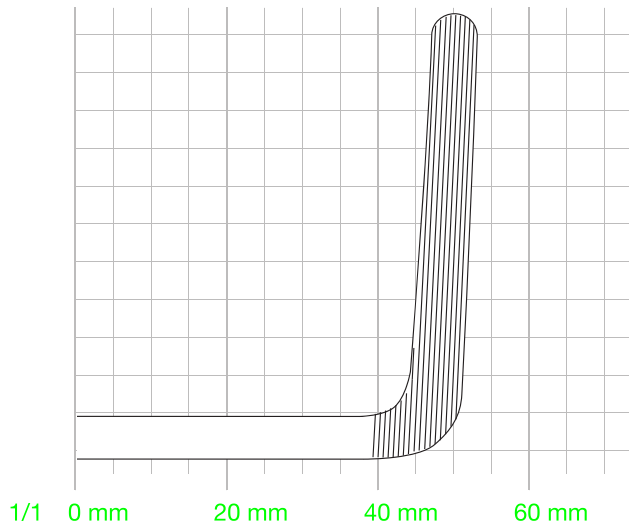

040-607-21	HEANEY	21,0cm; 8 1/4"
------------	--------	----------------

leichtes Modell | light jaws

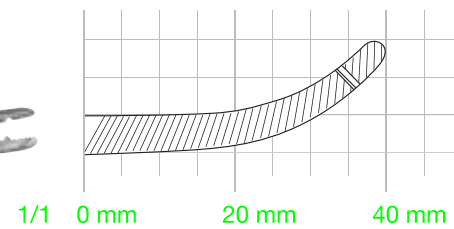
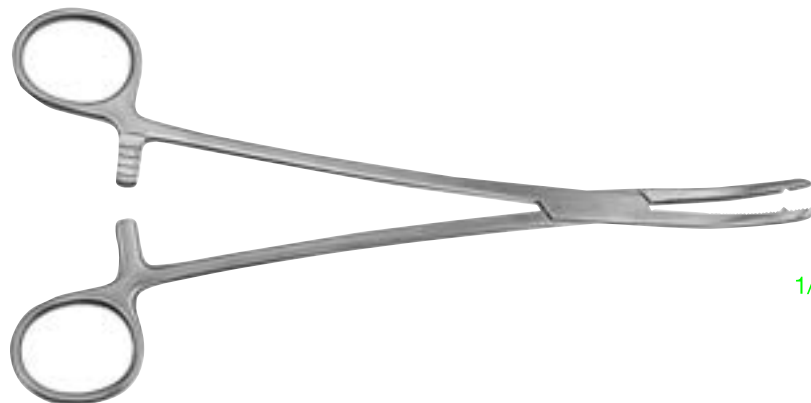

Hysterektomieklemmen
Hysterectomy Forceps

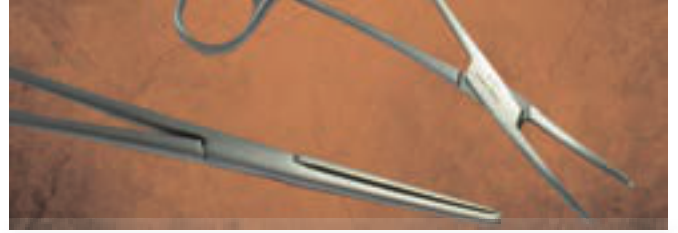

Art.Nr.	Beschreibung Description	Size	Spez.
	HEANEY-BALLANTINE	21,0cm; 8 1/4"	

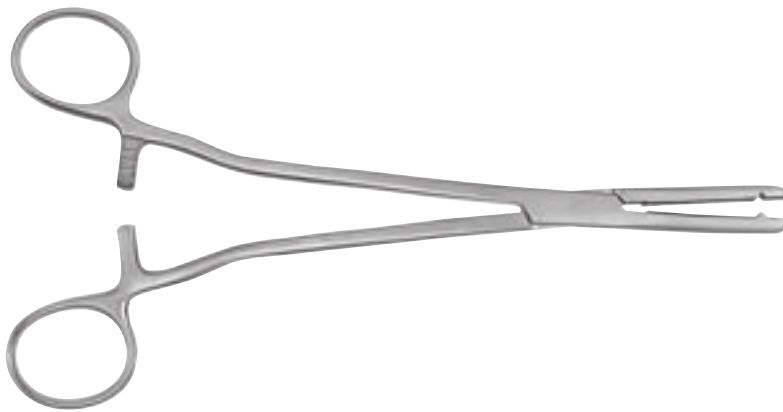

040-614-21

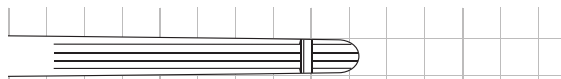

040-615-21

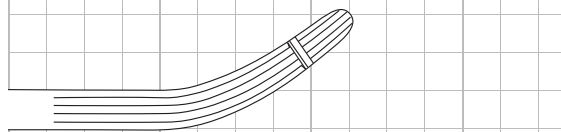

1/1 0 mm 20 mm 40 mm 60 mm

040-617-21	HEANEY-KANTER	21,0cm; 8 1/4"	
------------	---------------	----------------	--

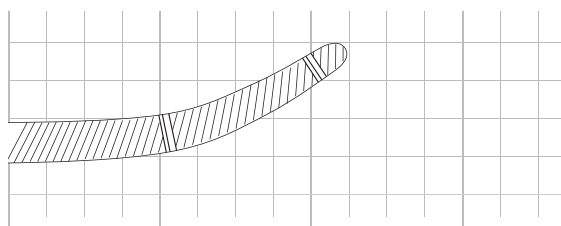

1/1 0 mm 20 mm 40 mm 60 mm

040

Art.Nr. Beschreibung | Description

HEANEY

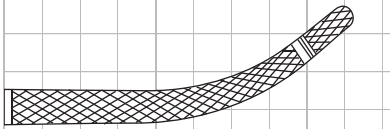
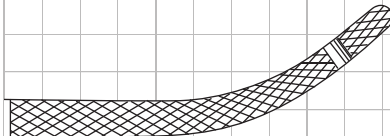
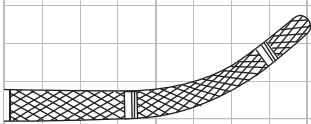
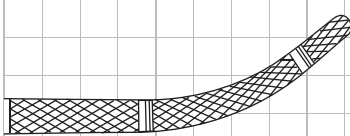
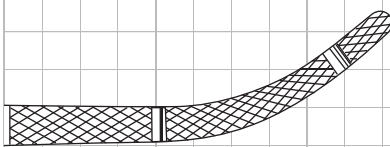

040-611-21		21,0cm; 8 1/4"
040-611-23		23,0cm; 9"
040-613-19		19,5cm; 7 3/4"
040-613-21		21,0cm; 8 1/4"
040-613-23		23,0cm; 9"

1/1 0 mm 20 mm 40 mm 60 mm

Weitere Artikel
further items



Art.Nr.	Beschreibung Description	Size	Spez.
Other items available but not illustrated			
040-165-14	CRILE haemostatic forceps; curved; serrated; fine Model	14,0cm; 5,6"	
040-330-14	COLLER haemostatic forceps straight; serrated	14,0cm; 5,6"	
040-330-16	straight; serrated	16,0cm; 6,4"	
040-331-14	curved; serrated	14,0cm; 5,6"	
040-331-16	curved; serrated	16,0cm; 6,4"	
040-401-16	O'SHAUGNESSY haemostatic forceps curved; serrated	16,0cm; 6,4"	
040-401-18	curved; serrated	18,0cm; 7,2"	
040-401-20	curved; serrated	20,0cm; 8"	
040-401-22	curved; serrated	22,0cm; 8,8"	
040-401-24	curved; serrated	24,0cm; 9,6"	
040-401-26	curved; serrated	26,0cm; 10,4"	
040-401-28	curved; serrated	28,0cm; 11,2"	
040-401-30	curved; serrated	30,0cm; 12"	
040-418-18	NISSEN haemostatic forceps curved; serrated	18,5cm; 7,4"	
040-418-22	curved; serrated	22,0cm; 8,8"	
040-427-06	OVERHOLT ligature forceps; curved; serrated	30,0cm; 12"	
040-440-29	HARRINGTON bronchus forceps; angled; serrated	29,5cm; 11,8"	
040-476-18	MIXTER-SLIM haemostatic forceps curved; serrated	18,0cm; 7,2"	
040-476-23	curved; serrated	23,0cm; 9,2"	
040-482-28	BRIDGE haemostatic forceps straight; serrated	28,0cm; 11,2"	
040-483-28	curved; serrated		
040-499-21	VANDERBILT UNIVERSITY Vessel clamp; curved; serrated	21,5cm; 8,6"	
040-523-24	GRAY Gall Duct clamp; s-shaped; curved; serrated	24,0cm; 9,6"	
040-551-18	Laufe Polypus forceps; curved; serrated	18,5cm; 7,4"	
040-561-20	SHALLCROSS Gall Duct clamp; curved; serrated	20,0cm; 8"	
040-580-27	Hysterectomy forceps straight; serrated	27,0cm; 10,8"	
040-580-30	straight; serrated	30,0cm; 12"	
040-580-35	straight; serrated	35,0cm; 14"	
040-581-27	slightly curved; serrated	27,0cm; 10,8"	
040-581-30	slightly curved; serrated	30,0cm; 12"	
040-581-35	slightly curved; serrated	35,0cm; 14"	

040

Weitere Artikel
further items

Art.Nr.	Beschreibung Description	Size	Spez.
Other items available but not illustrated			
	Hysterectomy forceps		
040-583-27	curved; serrated	27,0cm; 10,8"	
040-583-30	curved; serrated	30,0cm; 12"	
040-583-35	curved; serrated	35,0cm; 14"	
040-585-24	angled; serrated	24,0cm; 9,6"	
040-585-27	angled; serrated	27,0cm; 10,8"	
040-585-30	angled; serrated	30,0cm; 12"	
040-585-35	angled; serrated	35,0cm; 14"	
040-590-21	straight; shanks angled; serrated	21,5cm; 8,6"	
040-590-24	straight; shanks angled; serrated	24,0cm; 9,6"	
040-590-30	straight; shanks angled; serrated	30,0cm; 12"	
040-590-35	straight; shanks angled; serrated	35,0cm; 14"	
040-591-21	slightly curved; shanks angled; serrated	21,5cm; 8,6"	
040-591-24	slightly curved; shanks angled; serrated	24,0cm; 9,6"	
040-591-30	slightly curved; shanks angled; serrated	30,0cm; 12"	
040-591-35	slightly curved; shanks angled; serrated	35,0cm; 14"	
040-593-21	curved; shanks angled; serrated	21,5cm; 8,6"	
040-593-24	curved; shanks angled; serrated	24,0cm; 9,6"	
040-593-30	curved; shanks angled; serrated	30,0cm; 12"	
040-593-35	curved; shanks angled; serrated	35,0cm; 14"	
040-595-21	angled; shanks angled; serrated	21,5cm; 8,6"	
040-595-24	angled; shanks angled; serrated	24,0cm; 9,6"	
040-595-30	angled; shanks angled; serrated	30,0cm; 12"	
040-595-35	angled; shanks angled; serrated	35,0cm; 14"	
040-600-27	WERTHEIM Hysterectomy forceps; curved; serrated	27,0cm; 10,8"	
040-608-20	MAINGOT Hysterectomy forceps; straight; serrated	20,0cm; 8"	
040-619-21	HEANEY-REZAK Hysterectomy forceps straight; 1 tooth; cross serrated	21,0cm; 8,4"	
040-634-24	SEGOND-LANDAU Hysterectomy forceps straight; serrated	24,0cm; 9,6"	
040-637-25	FAURE Hysterectomy forceps; curved; serrated	25,0cm; 10"	
040-638-21	REICH NECHTOW Hysterectomy forceps straight; 1 teeth	21,0cm; 8,4"	
040-639-21	curved; 1 teeth		



Art.Nr.	Beschreibung Description	Size	Spez.
Other items available but not illustrated			
	WERTHEIM-DEBAKEY Parametrium forceps		
040-640-00	straight	21,0cm; 8,4"	
040-641-01	slightly curved	21,0cm; 8,4"	
040-641-02	curved	21,0cm; 8,4"	
040-641-03	strongly curved	21,0cm; 8,4"	
040-642-00	straight	25,0cm; 10"	
040-643-01	slightly curved	24,0cm; 9,6"	
040-643-02	curved	24,0cm; 9,6"	
040-643-03	strongly curved	24,0cm; 9,6"	
040-644-00	straight	27,0cm; 10,8"	
040-645-02	curved	27,0cm; 10,8"	
	MIKULICZ Peritoneal Clamp		
040-705-20	curved; serrated; 1X2 teeth	20,0cm; 8"	
040-707-20	curved; serrated; 1X2 teeth	20,0cm; 8"	
040-711-20	curved; serrated; 1X2 teeth	20,5cm; 8,2"	
040-725-20	SCHINDLER Peritoneal Clamp; straight; serrated; 1X2 teeth	20,0cm; 8"	
	BAINBRIDGE haemostatic forceps		
040-480-15	straight; serrated	15,0cm; 6"	
040-480-18	straight; serrated	18,5cm; 7,4"	
040-481-15	curved; serrated	15,0cm; 6"	
040-481-18	curved; serrated	18,5cm; 7,4"	
040-409-14	MICRO-ADSON haemostatic forceps; curved; serrated	14,0cm; 5,6"	
	TOENNIS haemostatic forceps		
040-442-21	straight; serrated	21,0cm; 8,4"	
040-442-26	straight; serrated	26,0cm; 10,4"	
040-443-21	curved; serrated	21,0cm; 8,4"	
040-443-26	curved; serrated	26,0cm; 10,4"	
040-444-21	straight; serrated; 1X2 teeth	21,0cm; 8,4"	
040-444-26	straight; serrated; 1X2 teeth	26,0cm; 10,4"	
040-445-21	curved; serrated; 1X2 teeth	21,0cm; 8,4"	
040-445-26	curved; serrated; 1X2 teeth	26,0cm; 10,4"	
	KANTROWITZ dissecting forceps		
040-433-20	curved; serrated	20,0cm; 8"	
040-433-24	curved; serrated	24,0cm; 9,6"	
040-433-28	curved; serrated	28,0cm; 11,2"	
040-511-23	STILLE Kidney Pedicle clamp; curved; serrated	23,0cm; 9,2"	
040-517-23	HERRICK Kidney Pedicle clamp; curved; serrated	23,0cm; 9,2"	
040-601-24	WERTHEIM Hysterectomy forceps; curved; 1X2 teeth; strong Model	24,0cm; 9,6"	

Weitere Artikel
further items

Art.Nr.	Beschreibung Description	Size	Spez.
Other items available but not illustrated			
040-606-20	MAINGOT Hysterectomy forceps; curved; 1X2 teeth	20,0cm; 8"	
040-606-25	MAINGOT Hysterectomy forceps; curved; 1X2 teeth	25,0cm; 10"	
040-621-19	LONG Hysterectomy forceps; curved; 1X2 teeth	19,0cm; 7,6"	



Alphabetisches Verzeichnis

A		
ADSON, Arterienklemme.....	040.23	
Arterienklemme, ADSON.....	040.23	
Arterienklemme, BABY-ADSON.....	040.23	
Arterienklemme, BENGOLEA.....	040.25	
Arterienklemme, BIRKETT.....	040.27	
Arterienklemme, CARREL.....	040.2	
Arterienklemme, CRAFOORD.....	040.26	
Arterienklemme, CRILE.....	040.8	
Arterienklemme, CRILE TITAN.....	040.8	
Arterienklemme, CRILE-RANKIN.....	040.10	
Arterienklemme, DANDY.....	040.9	
Arterienklemme, DANDY-MOSQUITO.....	040.8	
Arterienklemme, DIXON-LOVELACE.....	040.22	
Arterienklemme, FERGUSSON.....	040.51	
Arterienklemme, FUCHSIG.....	040.24	
Arterienklemme, GRAY.....	040.47	
Arterienklemme, HALSTED-MOSQUITO.....	040.3- 040.4	
Arterienklemme, HALSTED-MOSQUITO TITAN.....	040.5	
Arterienklemme, HARTMANN.....	040.2	
Arterienklemme, HEISS.....	040.24	
Arterienklemme, KELLY.....	040.6	
Arterienklemme, KELLY TITAN.....	040.7	
Arterienklemme, KELLY-RANKIN.....	040.7	
Arterienklemme, KOCHER DELICATE.....	040.14	
Arterienklemme, KOCHER-NIPPON.....	040.15	
Arterienklemme, KOCHER-OCHSNER.....	040.18- 040.19	
Arterienklemme, KROENLEIN.....	040.10	
Arterienklemme, LERICHE.....	040.9	
Arterienklemme, MICRO-MOSQUITO.....	040.3	
Arterienklemme, NEGUS.....	040.27	
Arterienklemme, PEAN.....	040.10	
Arterienklemme, PEAN DELICATE.....	040.12	
Arterienklemme, PEAN-NIPPON.....	040.13	
Arterienklemme, PROVIDENCE-HOSPITAL.....	040.6	
Arterienklemme, ROBERTS.....	040.28	
Arterienklemme, ROCHESTER-CARMALT.....	040.22	
Arterienklemme, ROCHESTER-PEAN.....	040.16- 040.17	
Arterienklemme, SAROT.....	040.26	
Arterienklemme, SPENCER-WELLS.....	040.11	
Arterienklemme, TERRIER.....	040.2	
B		
BABY-ADSON, Arterienklemme.....	040.23	
BABY-MIKULICZ, Peritoneumklemme.....	040.52	
BABY-MIXTER, Präparierklemme.....	040.39, 040.41	
BENGOLEA, Arterienklemme.....	040.25	
BIRKETT, Arterienklemme.....	040.27	
C		
CARREL, Arterienklemme.....	040.2	
CHAPUT, Gewebefasszange.....	040.20	
COLLIN, Gewebefasszange.....	040.21	
CRAFOORD, Arterienklemme.....	040.26	
CRAFOORD-SELLORS, Gallenkanalklemme.....	040.47	
CRILE TITAN, Arterienklemme.....	040.8	
CRILE, Arterienklemme.....	040.8	
CRILE-RANKIN, Arterienklemme.....	040.10	
D		
DANDY, Arterienklemme.....	040.9	
DANDY-MOSQUITO, Arterienklemme.....	040.8	
DESJARDINS, Präparierklemme.....	040.44	
DIXON-LOVELACE, Arterienklemme.....	040.22	
F		
Fasszange, Gewebe-, COLLIN.....	040.20	
Fasszange, Gewebe-, PENNINGTON.....	040.21	
Fasszange, Gewebe-, CHAPUT.....	040.20	
Fasszange, Gewebe-, COLLIN.....	040.21	
Fasszange, Gewebe-, TUFFIER.....	040.20	
Fasszange, Organ-,.....	040.50	
Fasszange, Organ-, PRATT.....	040.50	
FAURE, Peritoneumklemme.....	040.53	
FERGUSSON, Arterienklemme.....	040.51	
FINOCCHIETTO, Präparierklemme.....	040.46	
FUCHSIG, Arterienklemme.....	040.24	
G		
Gallenkanalklemme, CRAFOORD-SELLORS.....	040.47	
Gallenkanalklemme, LAHEY.....	040.44	
GEMINI, Präparierklemme.....	040.38	
Gewebefasszange, CHAPUT.....	040.20	
Gewebefasszange, COLLIN.....	040.20	
GRAY, Arterienklemme.....	040.47	
GUYON, Nierenstielklemme.....	040.48	
GUYON, Nierenstielklemme, atraumatisch.....	040.49	
H		
HALSTED-MOSQUITO TITAN, Arterienklemme.....	040.4- 040.5	
HALSTED-MOSQUITO, Arterienklemme.....	040.3- 040.4	
HARTMANN, Arterienklemme.....	040.2	
HEANEY, Hysterektomieklammer.....	040.57, 040.59	
HEANEY-BALLENTINE, Hysterektomieklammer.....	040.58	
HEANEY-KANTER, Hysterektomieklammer.....	040.58	
HEISS, Arterienklemme.....	040.24	
Hysterektomieklammer, HEANEY.....	040.57, 040.59	
Hysterektomieklammer, HEANEY-BALLENTINE.....	040.58	
Hysterektomieklammer, HEANEY-KANTER.....	040.58	
Hysterektomieklammer, MOYNIHAN.....	040.55	
Hysterektomieklammer, PHANEUF.....	040.54	
Hysterektomieklammer, ROGERS.....	040.56	
Hysterektomieklammer, WERTHEIM.....	040.54- 040.55	
Hysterektomieklammer, WERTHEIM-CULLEN.....	040.57	
J		
JOHNS HOPKINS, Präparierklemme.....	040.39	
K		
KELLY TITAN, Arterienklemme.....	040.7	
KELLY, Arterienklemme.....	040.6	
KELLY, Präparierklemme.....	040.42	

Alphabetisches Verzeichnis

KELLY-RANKIN, Arterienklemme.....	040.7	Klemme, Präparier-, BABY-MIXTER.....	040.39, 040.41
Klemme, Arterien-, ADSON.....	040.23	Klemme, Präparier-, DESJARDINS.....	040.44
Klemme, Arterien-, BABY-ADSON.....	040.23	Klemme, Präparier-, FINOCCHIETTO.....	040.46
Klemme, Arterien-, BENGOLEA.....	040.25	Klemme, Präparier-, GEMINI.....	040.38
Klemme, Arterien-, BIRKETT.....	040.27	Klemme, Präparier-, JOHNS-HOPKINS.....	040.39
Klemme, Arterien-, CARREL.....	040.2	Klemme, Präparier-, KELLY.....	040.42
Klemme, Arterien-, CRAFOORD.....	040.26	Klemme, Präparier-, LAWRENCE.....	040.44
Klemme, Arterien-, CRILE.....	040.8	Klemme, Präparier-, LOWER.....	040.45
Klemme, Arterien-, CRILE TITAN.....	040.8	Klemme, Präparier-, MEEKER.....	040.43
Klemme, Arterien-, CRILE-RANKIN.....	040.10	Klemme, Präparier-, MINI-GEMINI.....	040.37
Klemme, Arterien-, DANDY.....	040.9	Klemme, Präparier-, MIXTER.....	040.40, 040.41, 040.45
Klemme, Arterien-, DANDY-MOSQUITO.....	040.8	Klemme, Präparier-, MIXTER-O' SHAUGNESSY.....	040.40
Klemme, Arterien-, DIXON-LOVELACE.....	040.22	Klemme, Präparier-, OVERHOLT.....	040.29, 040.31
Klemme, Arterien-, FERGUSSON.....	040.51	Klemme, Präparier-, OVERHOLT-BABY.....	040.32
Klemme, Arterien-, FUCHSIG.....	040.24	Klemme, Präparier-, OVERHOLT-FINO.....	040.30
Klemme, Arterien-, GRAY.....	040.47	Klemme, Präparier-, OVERHOLT-GEISSENDOERFER.....	040.34- 040.36
Klemme, Arterien-, HALSTED-MOSQUITO.....	040.3- 040.4	Klemme, Präparier-, OVERHOLT-MINI.....	040.31
Klemme, Arterien-, HALSTED-MOSQUITO TITAN.....	040.5	Klemme, Präparier-, OVERHOLT-MIXTER.....	040.32
Klemme, Arterien-, HARTMANN.....	040.2	Klemme, Präparier-, RUMEL.....	040.33
Klemme, Arterien-, HEISS.....	040.24	Klemme, Präparier-, WIKSTROEM.....	040.37
Klemme, Arterien-, KELLY.....	040.6	Klemme, Präparier-, ZENKER.....	040.43
Klemme, Arterien-, KELLY TITAN.....	040.7	KOCHER DELICATE, Arterienklemme.....	040.14
Klemme, Arterien-, KELLY-RANKIN.....	040.7	KOCHER-NIPPON, Arterienklemme.....	040.15
Klemme, Arterien-, KOCHER-NIPPON.....	040.15	KOCHER-OCHSNER, Arterienklemme.....	040.18- 040.19
Klemme, Arterien-, KOCHER-OCHSNER.....	040.18- 040.19	Kopfhautklemme, MARTEL.....	040.51
Klemme, Arterien-, KROENLEIN.....	040.10	Kopfhautklemme, WILLET-MARTEL.....	040.51
Klemme, Arterien-, LERICHE.....	040.9	KROENLEIN, Arterienklemme.....	040.10
Klemme, Arterien-, MICRO-MOSQUITO.....	040.3		
Klemme, Arterien-, NEGUS.....	040.27	L	
Klemme, Arterien-, PEAN.....	040.10	LAHEY, Gallenkanalklemme.....	040.44
Klemme, Arterien-, PEAN DELICATE.....	040.12	LAWRENCE, Präparierklemme.....	040.44
Klemme, Arterien-, PEAN-NIPPON.....	040.13	LERICHE, Arterienklemme.....	040.9
Klemme, Arterien-, PROVIDENCE-HOSPITAL.....	040.6	LOWER, Präparierklemme.....	040.45
Klemme, Arterien-, ROBERTS.....	040.28		
Klemme, Arterien-, ROCHESTER-CARMALT.....	040.22	M	
Klemme, Arterien-, ROCHESTER-PEAN.....	040.16- 040.17	MARTEL, Kopfhautklemme.....	040.51
Klemme, Arterien-, SAROT.....	040.26	MEEKER, Präparierklemme.....	040.43
Klemme, Arterien-, SPENCER-WELLS.....	040.11	MICRO-MOSQUITO, Arterienklemme.....	040.3
Klemme, Arterien-, TERRIER.....	040.2	MIKULICZ, Peritoneumklemme.....	040.52
Klemme, Gallenkanal-, CRAFOORD-SELLORS.....	040.47	MINI-GEMINI, Präparierklemme.....	040.37
Klemme, Gallenkanal-, LAHEY.....	040.44	MIXTER, Präparierklemme.....	040.40, 040.41, 040.45
Klemme, Hysterektomie-, HEANEY.....	040.57, 040.59	MIXTER-O' SHAUGNESSY, Präparierklemme.....	040.40
Klemme, Hysterektomie-, HEANEY-BALLENTINE.....	040.58	MOYNIHAN, Hysterektomieklamme.....	040.55
Klemme, Hysterektomie-, HEANEY-KANTER.....	040.58		
Klemme, Hysterektomie-, MOYNIHAN.....	040.55	N	
Klemme, Hysterektomie-, PHANEUF.....	040.54	NEGUS, Arterienklemme.....	040.27
Klemme, Hysterektomie-, ROGERS.....	040.56	Nierenstielklemme, GUYON.....	040.48
Klemme, Hysterektomie-, WERTHEIM.....	040.54- 040.55	Nierenstielklemme, GUYON, atraumatisch.....	040.49
Klemme, Hysterektomie-, WERTHEIM-CULLEN.....	040.57		
Klemme, Kopfhaut-, MARTEL.....	040.51	O	
Klemme, Kopfhaut-, WILLET-MARTEL.....	040.51	Organfasszange.....	040.50
Klemme, Nierenstiel-, GUYON.....	040.48	Organfasszange, PRATT.....	040.50
Klemme, Nierenstiel-, GUYON, atraumatisch.....	040.49	OVERHOLT, Präparierklemme.....	040.29, 040.31
Klemme, Peritoneum-, BABY-MIKULICZ.....	040.52	OVERHOLT-BABY, Präparierklemme.....	040.32
Klemme, Peritoneum-, FAURE.....	040.53	OVERHOLT-FINO, Präparierklemme.....	040.30
Klemme, Peritoneum-, MIKULICZ.....	040.52- 040.53		



Alphabetisches Verzeichnis

OVERHOLT-GEISSENDOERFER,
 Präparierklemme 040.34- 040.36
 OVERHOLT-MINI, Präparierklemme 040.31
 OVERHOLT-MIXTER, Präparierklemme 040.32

P

PEAN DELICATE, Arterienklemme 040.12
 PEAN, Arterienklemme 040.10
 PEAN-NIPPON, Arterienklemme 040.13
 PENNINGTON, Gewebefasszange 040.21
 Peritoneumklemme, BABY-MIKULICZ 040.52
 Peritoneumklemme, FAURE 040.53
 Peritoneumklemme, MIKULICZ 040.52- 040.53
 PHANEUF, Hysterektomieklemme 040.54
 Präparierklemme, OVERHOLT-BABY 040.32
 Präparierklemme, BABY-MIXTER 040.39, 040.41
 Präparierklemme, DESJARDINS 040.44
 Präparierklemme, FINOCCHIETTO 040.46
 Präparierklemme, GEMINI 040.38
 Präparierklemme, JOHNS-HOPKINS 040.39
 Präparierklemme, KELLY 040.42
 Präparierklemme, LAWRENCE 040.44
 Präparierklemme, LOWER 040.45
 Präparierklemme, MEEKER 040.43
 Präparierklemme, MINI-GEMINI 040.37
 Präparierklemme, MIXTER 040.40, 040.41, 040.45
 Präparierklemme, MIXTER-O'SHAUGNESSY 040.40
 Präparierklemme, OVERHOLT 040.29, 040.31
 Präparierklemme, OVERHOLT-FINO 040.30
 Präparierklemme, OVERHOLT-GEISSENDOERFER
 040.34- 040.36
 Präparierklemme, OVERHOLT-MINI 040.31
 Präparierklemme, OVERHOLT-MIXTER 040.32
 Präparierklemme, RUMEL 040.33
 Präparierklemme, WIKSTROEM 040.37
 Präparierklemme, ZENKER 040.43
 PRATT, Organfasszange 040.50
 PROVIDENCE-HOSPITAL, Arterienklemme 040.6

R

ROBERTS, Arterienklemme 040.28
 ROCHESTER-CARMALT, Arterienklemme 040.22
 ROCHESTER-PEAN, Arterienklemme 040.16- 040.17
 ROGERS, Hysterektomieklemme 040.56
 RUMEL, Präparierklemme 040.33

S

SAROT, Arterienklemme 040.26
 SPENCER-WELLS, Arterienklemme 040.11

T

TERRIER, Arterienklemme 040.2
 TUFFIER, Gewebefasszange 040.20

W

WERTHEIM, Hysterektomieklemme 040.54- 040.55
 WERTHEIM-CULLEN, Hysterektomieklemme 040.57
 WIKSTROEM, Präparierklemme 040.37
 WILLET-MARTEL, Kopfhautklemme 040.51

Z

ZENKER, Präparierklemme 040.43

Index, alphabetical

A	
ADSON, haemostatic forceps	040.23
B	
BABY-ADSON, haemostatic forceps.....	040.23
BABY-MIKULICZ, peritoneum forceps.....	040.52
BABY-MIXTER, dissecting and ligature forceps....	040.39, 040.41
BENGOLEA, haemostatic forceps.....	040.25
bile duct clamp, GRAFOORD-SELLORS	040.47
bile duct clamp, LAHEY	040.44
BIRKETT, haemostatic forceps.....	040.27
C	
CARREL, haemostatic forceps.....	040.2
CHAPUT, tissue grasping forceps.....	040.20
clamp, bile duct, CRAFOORD-SELLORS	040.47
clamp, bile duct, LAHEY	040.44
clamp, kidney pedicle, GUYON.....	040.48- 040.49
COLLIN, tissue grasping forceps	040.20- 040.21
CRAFOORD, haemostatic forceps.....	040.26
CRAFOORD-SELLORS, bile duct clamp	040.47
CRILE TITAN, haemostatic forceps.....	040.8
CRILE, haemostatic forceps.....	040.8
CRILE-RANKIN, haemostatic forceps.....	040.10
D	
DANDY, haemostatic forceps.....	040.9
DANDY-MOSQUITO, haemostatic forceps	040.8
DESJARDINS, dissecting and ligature forceps	040.44
dissecting and ligature forceps, BABY-MIXTER....	040.39, 040.41
dissecting and ligature forceps, DESJARDINS	040.44
dissecting and ligature forceps, FINOCCHIETTO	040.46
dissecting and ligature forceps, GEMINI.....	040.38
dissecting and ligature forceps, JOHNS-HOPKINS.....	040.39
dissecting and ligature forceps, KELLY.....	040.42
dissecting and ligature forceps, LAWRENCE.....	040.44
dissecting and ligature forceps, LOWER.....	040.45
dissecting and ligature forceps, MEEKER.....	040.43
dissecting and ligature forceps, MINI-GEMINI.....	040.37
dissecting and ligature forceps, MIXTER .040.40, 040.41, 040.45	
dissecting and ligature forceps, MIXTER-O'SHAUGNESSY.....	040.40
dissecting and ligature forceps, OVERHOLT.....	040.29, 040.31
dissecting and ligature forceps, OVERHOLT-FINO	040.30
dissecting and ligature forceps, OVERHOLT-GEISSENDOERFER.....	040.34- 040.36
dissecting and ligature forceps, OVERHOLT-MINI	040.31
dissecting and ligature forceps, OVERHOLT-MIXTER.....	040.32
dissecting and ligature forceps, RUMEL.....	040.33
dissecting and ligature forceps, WIKSTROEM.....	040.37
dissecting and ligature forceps, ZENKER	040.43
forceps, haemostatic, ADSON	040.23
forceps, haemostatic, BABY-ADSON.....	040.23
forceps, haemostatic, BENGOLEA.....	040.25
forceps, haemostatic, BIRKETT	040.27
forceps, haemostatic, CARREL.....	040.2
forceps, haemostatic, CRAFOORD.....	040.26
forceps, haemostatic, CRILE.....	040.8
forceps, haemostatic, CRILE TITAN.....	040.8
forceps, haemostatic, CRILE-RANKIN	040.10
forceps, haemostatic, DANDY	040.9
forceps, haemostatic, DANDY-MOSQUITO	040.8
forceps, haemostatic, DIXON-LOVELACE	040.22
forceps, haemostatic, FERGUSSON.....	040.51
forceps, haemostatic, FUCHSIG.....	040.24
forceps, haemostatic, GRAY	040.47
forceps, haemostatic, HALSTED.....	040.4
forceps, haemostatic, HALSTED-MOSQUITO	040.3
forceps, haemostatic, HALSTED-MOSQUITO TITAN	040.5
forceps, haemostatic, HARTMANN.....	040.2
forceps, haemostatic, HEISS	040.24
forceps, haemostatic, KELLY	040.6
forceps, haemostatic, KELLY TITAN.....	040.7
forceps, haemostatic, KELLY-RANKIN	040.7
forceps, haemostatic, KOCHER DELICATE	040.14
forceps, haemostatic, KOCHER-NIPPON.....	040.15
forceps, haemostatic, KOCHER-OCHSNER.....	040.18- 040.19
forceps, haemostatic, KROENLEIN.....	040.10
forceps, haemostatic, LERICHE.....	040.9
forceps, haemostatic, MICRO-MOSQUITO	040.3
forceps, haemostatic, NEGUS	040.27
forceps, haemostatic, PEAN	040.10
forceps, haemostatic, PEAN DELICATE.....	040.12
FINOCCHIETTO, dissecting and ligature forceps	040.46
forceps, dissecting and ligature, BABY-MIXTER...040.39, 040.41	
forceps, dissecting and ligature, DESJARDINS	040.44
forceps, dissecting and ligature, FINOCCHIETTO	040.46
forceps, dissecting and ligature, GEMINI.....	040.38
forceps, dissecting and ligature, JOHNS HOPKINS	040.39
forceps, dissecting and ligature, KELLY.....	040.42
forceps, dissecting and ligature, LAWRENCE.....	040.44
forceps, dissecting and ligature, LOWER.....	040.45
forceps, dissecting and ligature, MEEKER.....	040.43
forceps, dissecting and ligature, MINI-GEMINI.....	040.37
forceps, dissecting and ligature, MIXTER 040.40, 040.41, 040.45	
forceps, dissecting and ligature, MIXTER-O'SHAUGNESSY	040.40
forceps, dissecting and ligature, OVERHOLT.....	040.29, 040.31
forceps, dissecting and ligature, OVERHOLT-BABY	040.32
forceps, dissecting and ligature, OVERHOLT-FINO	040.30
forceps, dissecting and ligature, OVERHOLT-GEISSENDOERFER.....	040.34- 040.36
forceps, dissecting and ligature, OVERHOLT-MINI	040.31
forceps, dissecting and ligature, OVERHOLT-MIXTER.....	040.32
forceps, dissecting and ligature, RUMEL.....	040.33
forceps, dissecting and ligature, WIKSTROEM.....	040.37
forceps, dissecting and ligature, ZENKER	040.43
F	
FAURE, peritoneum forceps.....	040.53
FERGUSSON, haemostatic forceps.....	040.51



Index, alphabetical

forceps, haemostatic, PEAN-NIPPON	040.13
forceps, haemostatic, PROVIDENCE-HOSPITAL	040.6
forceps, haemostatic, ROBERTS	040.28
forceps, haemostatic, ROCHESTER-CARMALT	040.22
forceps, haemostatic, ROCHESTER-PEAN	040.16- 040.17
forceps, haemostatic, SAROT	040.26
forceps, haemostatic, SPENCER-WELLS	040.11
forceps, haemostatic, TERRIER	040.2
forceps, hysterectomy, HEANEY	040.57, 040.59
forceps, hysterectomy, HEANEY-BALLANTINE	040.58
forceps, hysterectomy, HEANEY-KANTER	040.58
forceps, hysterectomy, MOYNIHAN	040.55
forceps, hysterectomy, PHANEUF	040.54
forceps, hysterectomy, ROGERS	040.56
forceps, hysterectomy, WERTHEIM	040.54- 040.55
forceps, hysterectomy, WERTHEIM-CULLEN	040.57
forceps, organ grasping	040.50
forceps, organ grasping, PRATT	040.50
forceps, peritoneum, BABY-MIKULICZ	040.52
forceps, peritoneum, FAURE	040.53
forceps, peritoneum, MIKULICZ	040.52- 040.53
forceps, scalp flap, MARTEL	040.51
forceps, scalp flap, WILLET-MARTEL	040.51
forceps, tissue grasping, CHAPUT	040.20
forceps, tissue grasping, COLLIN	040.20- 040.21
forceps, tissue grasping, PENNINGTON	040.21
forceps, tissue grasping, TUFFIER	040.20
FUCHSIG, haemostatic forceps	040.24

G

GEMINI, dissecting and ligature forceps	040.38
GRAY, haemostatic forceps	040.47
GUYON, kidney pedicle clamp	040.48- 040.49

H

haemostatic forceps, ADSON	040.23
haemostatic forceps, BABY-ADSON	040.23
haemostatic forceps, BENGOLEA	040.25
haemostatic forceps, BIRKETT	040.27
haemostatic forceps, CARREL	040.2
haemostatic forceps, CRILE	040.8
haemostatic forceps, CRILE TITAN	040.8
haemostatic forceps, CRILE-RANKIN	040.10
haemostatic forceps, DANDY	040.9
haemostatic forceps, DANDY-MOSQUITO	040.8
haemostatic forceps, DIXON-LOVELACE	040.22
haemostatic forceps, FERGUSSON	040.51
haemostatic forceps, FUCHSIG	040.24
haemostatic forceps, GRAFOORD	040.26
haemostatic forceps, GRAY	040.47
haemostatic forceps, HALSTED-MOSQUITO	040.3- 040.4
haemostatic forceps, HALSTED-MOSQUITO TITAN	040.5
haemostatic forceps, HARTMANN	040.2
haemostatic forceps, HEISS	040.24
haemostatic forceps, KELLY	040.6
haemostatic forceps, KELLY TITAN	040.7

haemostatic forceps, KELLY-RANKIN	040.7
haemostatic forceps, KOCHER DELICATE	040.14
haemostatic forceps, KOCHER-NIPPON	040.15
haemostatic forceps, KOCHER-OCHSNER	040.18- 040.19
haemostatic forceps, KROENLEIN	040.10
haemostatic forceps, LERICHE	040.9
haemostatic forceps, MICRO-MOSQUITO	040.3
haemostatic forceps, NEGUS	040.27
haemostatic forceps, OVERHOLT-BABY	040.32
haemostatic forceps, PEAN	040.10
haemostatic forceps, PEAN DELICATE	040.12
haemostatic forceps, PEAN-NIPPON	040.13
haemostatic forceps, PROVIDENCE-HOSPITAL	040.6
haemostatic forceps, ROBERTS	040.28
haemostatic forceps, ROCHESTER-CARMALT	040.22
haemostatic forceps, ROCHESTER-PEAN	040.16- 040.17
haemostatic forceps, SAROT	040.26
haemostatic forceps, SPENCER-WELLS	040.11
haemostatic forceps, TERRIER	040.2
HALSTED-MOSQUITO TITAN, haemostatic forceps	040.4- 040.5
HALSTED-MOSQUITO, haemostatic forceps	040.3- 040.4
HARTMANN, haemostatic forceps	040.2
HEANEY, hysterectomy forceps	040.57, 040.59
HEANEY-BALLANTINE, hysterectomy forceps	040.58
HEANEY-KANTER, hysterectomy forceps	040.58
HEISS, haemostatic forceps	040.24
hysterectomy forceps, HEANEY	040.59
hysterectomy forceps, HEANEY-BALLANTINE	040.58
hysterectomy forceps, HEANEY-KANTER	040.58
hysterectomy forceps, MOYNIHAN	040.55
hysterectomy forceps, PHANEUF	040.54
hysterectomy forceps, ROGERS	040.56
hysterectomy forceps, WERTHEIM	040.54- 040.55
hysterectomy forceps, WERTHEIM-CULLEN	040.57
hysterectomy, HEANEY	040.57

J

JOHNS-HOPKINS, dissecting and ligature forceps	040.39
--	--------

K

KELLY TITAN, haemostatic forceps	040.7
KELLY, dissecting and ligature forceps	040.42
KELLY, haemostatic forceps	040.6
KELLY-RANKIN, haemostatic forceps	040.7
kidney pedicle clamp, GUYON	040.48- 040.49
KOCHER DELICATE, haemostatic forceps	040.14
KOCHER-NIPPON, haemostatic forceps	040.15
KOCHER-OCHSNER, haemostatic forceps	040.18- 040.19
KROENLEIN, haemostatic forceps	040.10

L

LAHEY, bile duct clamp	040.44
LAWRENCE, dissecting and ligature forceps	040.44
LERICHE, haemostatic forceps	040.9
LOWER, dissecting and ligature forceps	040.45

Index, alphabetical

M

MARTEL, scalp flap forceps.....	040.51
MEEKER, dissecting and ligature forceps.....	040.43
MICRO-MOSQUITO, haemostatic forceps	040.3
MIKULICZ, peritoneum forceps	040.52- 040.53
MINI-GEMINI, dissecting and ligature forceps.....	040.37
MIXTER, dissecting and ligature forceps .	040.40, 040.41, 040.45
MIXTER-O'SHAUGNESSY, dissecting and ligature forceps	040.40
MOYNIHAN, hysterectomy forceps.....	040.55

N

NEGUS, haemostatic forceps	040.27
----------------------------------	--------

O

organ grasping forceps	040.50
organ grasping forceps, PRATT	040.50
OVERHOLT, dissecting and ligature forceps	040.29, 040.31
OVERHOLT-BABY, haemostatic forceps	040.32
OVERHOLT-FINO, dissecting and ligature forceps	040.30
OVERHOLT-GEISSENDOERFER, dissecting and ligature forceps	040.34- 040.36
OVERHOLT-MINI, dissecting and ligature forceps	040.31
OVERHOLT-MIXTER, dissecting and ligature forceps.....	040.32

P

PEAN DELICATE, haemostatic forceps.....	040.12
PEAN, haemostatic forceps	040.10
PEAN-NIPPON, haemostatic forceps	040.13
PENNINGTON, tissue grasping forceps.....	040.21
peritoneum forceps, BABY-MIKULICZ.....	040.52
peritoneum forceps, FAURE.....	040.53
peritoneum forceps, MIKULICZ	040.52- 040.53
PHANEUF, hysterectomy forceps.....	040.54
PRATT, organ grasping forceps.....	040.50
PROVIDENCE-HOSPITAL, haemostatic forceps.....	040.6

R

ROBERTS, haemostatic forceps	040.28
ROCHESTER-CARMALT, haemostatic forceps.....	040.22
ROCHESTER-PEAN, haemostatic forceps	040.16- 040.17
ROGERS, hysterectomy forceps.....	040.56
RUMEL, dissecting and ligature forceps.....	040.33

S

SAROT, haemostatic forceps	040.26
scalp flap forceps, MARTEL	040.51
scalp flap forceps, WILLET-MARTEL	040.51
SPENCER-WELLS, haemostatic forceps.....	040.11

T

TERRIER, haemostatic forceps	040.2
tissue grasping forceps, CHAPUT.....	040.20
tissue grasping forceps, COLLIN	040.20
tissue grasping forceps, PENNINGTON.....	040.21
tissue grasping forceps, TUFFIER.....	040.20
TUFFIER, tissue grasping forceps.....	040.20

W

WERTHEIM, hysterectomy forceps	040.54- 040.55
WERTHEIM-CULLEN, hysterectomy forceps.....	040.57
WIKSTROEM, dissecting and ligature forceps.....	040.37
WILLET-MARTEL, scalp flap forceps	040.51

Z

ZENKER, dissecting and ligature forceps	040.43
---	--------