

skin retractor

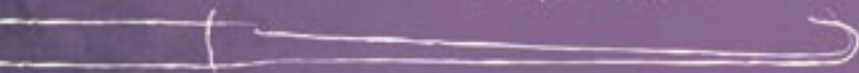

vein retractor



tracheal hooks







Wundhaken
Retractors

062

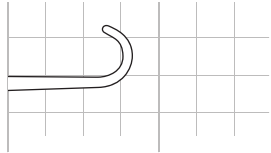

Dura und Venenhaken
 Dura and vein hooks
 Ganchos para dura-madre y venas

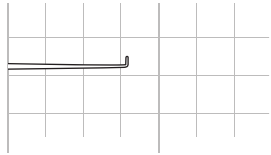

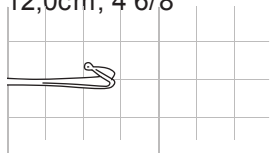
Art.Nr.	Beschreibung Description	Size	Spez.
062-010-16	GRAHAM	16,0cm; 6 2/8"	
			
		1/1 0 mm 20 mm	
062-011-18	SACHS	18,0cm; 7 1/8"	
			
		1/1 0 mm 20 mm	
062-012-01	FISCH	19,0cm; 7 4/8"	
			
		1/1 0 mm 20 mm	
062-012-02	FISCH	19,0cm; 7 4/8"	
			
		1/1 0 mm 20 mm	
062-018-13	MOLDESTAD	12,0cm; 4 6/8"	
			
		1/1 0 mm 20 mm	

062

Dura und Venenhaken; Wundäkchen
 Dura and vein hooks; Hooklets
 Ganchos para dura-madre y venas; Ganchitos

Art.Nr.	Beschreibung Description	Size	Spez.
	BROM	19,0cm; 7 4/8"	



062-020-05

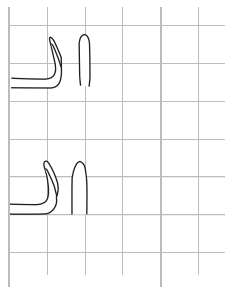

schmal | narrow | estrecho

062-020-07



breit | wide | ancho

1/1 0 mm 20 mm

GRAEFE Schielhaken
 Strabismus hooks
 Ganchos para estrabismo



062-040-13

13,0cm; 5 1/8"

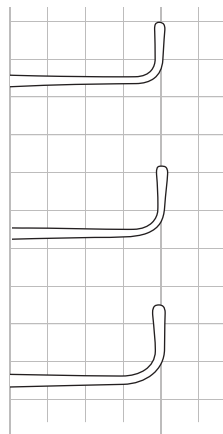

062-040-14

14,0cm; 5 4/8"

062-040-15

14,5cm; 5 6/8"

1/1 0 mm 20 mm

Wundhäkchen
Hooklets
Ganchitos



Art.Nr.	Beschreibung Description	Size	Spez.
---------	----------------------------	------	-------

GILLIES

18,0cm; 7 1/8"



062-050-01

Fig. 1

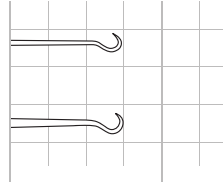

062-050-02

Fig. 2

1/1 0 mm 20 mm

062-054-15

KILNER

14,5cm; 5 6/8"

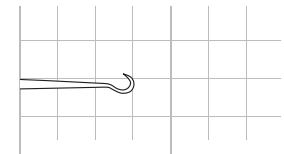

1/1 0 mm 20 mm

KLEINERT-KUTZ

16,0cm; 6 2/8"



062-058-01

Fig. 1

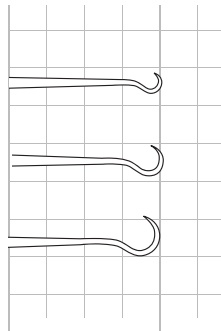

062-058-02

Fig. 2

062-058-03

Fig. 3

1/1 0 mm 20 mm

062-060-13

FRAZIER



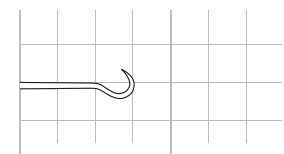





13,0cm; 5 1/8"

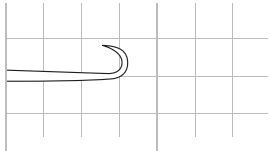

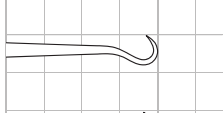
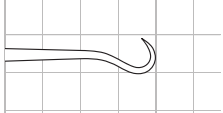
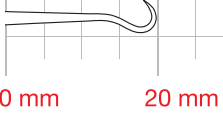
1/1 0 mm 20 mm

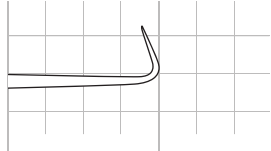
062

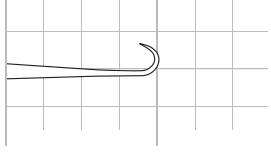
Wundhäkchen
Hooklets
Ganchitos

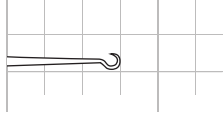
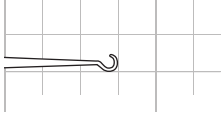
Art.Nr.	Beschreibung Description	Size	Spez.
062-062-16	JOSEPH 	15,5cm; 6 1/8" 	
		1/1 0 mm 20 mm	
		16,0cm; 6 2/8"	
062-070-01	Fig. 1 	062-070-03	Fig. 3 
062-070-02	Fig. 2 	062-070-04	Fig. 4 
	1/1 0 mm 20 mm		1/1 0 mm 20 mm
062-071-16	COTTLE 	16,0cm; 6 2/8" 	
		1/1 0 mm 20 mm	
062-074-16	O'CONNOR 	16,0cm; 6 2/8" 	
		1/1 0 mm 20 mm	
	GRAEFE 	12,0cm; 4 3/4"	
062-076-01	spitz sharp agudo 	062-076-02	stumpf blunt romo 
	1/1 0 mm 20 mm		1/1 0 mm 20 mm

Wundhäkchen
Hooklets
Ganchitos



Art.Nr.	Beschreibung Description	Size	Spez.
	GRAEFE	16,0cm; 6 2/8"	
062-078-01	Fig. 1 1/1 0 mm 20 mm	062-078-02	Fig. 2 1/1 0 mm 20 mm
	GUTHRIE	16,0cm; 6 2/8"	
062-080-01	Fig. 1 1/1 0 mm 20 mm	062-080-02	Fig. 2 1/1 0 mm 20 mm
062-081-13	ROLLET	13,0cm; 5 1/8"	
	Knapp	13,0cm; 5 1/8"	
062-082-01	Fig.1 spitz sharp agudo	062-082-02	Fig. 2 stumpf blunt romo
062-083-12	GUTHRIE	12,5cm; 5"	
062-083-13	GUTHRIE	13,0cm; 5 1/8"	
062-087-15	FREER	15,0cm; 5 7/8"	

062

Wundhäkchen; Trachealhaken
 Hooklets; Tracheal Hooks
 Ganchitos; Ganchos traqueales

Art.Nr.	Beschreibung Description	Size	Spez.
---------	----------------------------	------	-------

062-086-01 JOSEPH 16,0cm; 6 2/8"



JOSEPH 16,0cm; 6 2/8"



062-086-02 2 mm 062-086-07 7 mm



062-086-05 5 mm 062-086-10 10 mm



Trachealhäkchen flexibel flexible flexibles 15,5cm; 6 1/8"



062-088-02 062-089-02



062-088-03 spitz sharp 062-089-03 stumpf blunt agudo romo

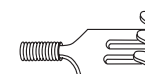
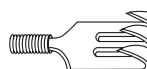

062-088-04 062-089-04

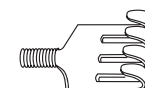
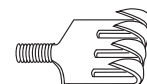

16,5cm; 6 4/8"





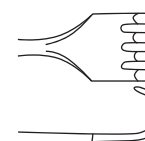
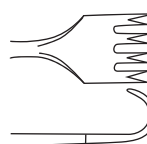

062-090-04 spitz sharp 062-091-04 stumpf blunt agudo romo

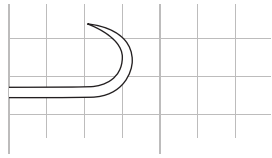

Trachealhaken
Tracheal Hooks
Ganchos traqueales



Art.Nr.	Beschreibung Description	Size	Spez.
062-092-15	NEWS 	14,5cm; 5 6/8"  1/1 0 mm 20 mm	
062-093-15	JACKSON 	15,0cm; 5 7/8"	
062-094-03	JACKSON 	18,0cm; 7 1/8"	
062-096-13	ROSE 	13,0cm; 5 1/8"	
062-097-11	LUER 	11,0cm; 4 3/8"	

062

Trachealhaken
 Tracheal Hooks
 Ganchos traqueales

Art.Nr.	Beschreibung Description	Size	Spez.
062-098-01	BOSE links left izquierdo	16,0cm; 6 2/8"	



062-098-02	BOSE rechts right derecho	16,0cm; 6 2/8"	
------------	------------------------------------	----------------	--



	ITERSON	17,0cm; 6 6/8"	
--	---------	----------------	--



062-099-01	Fig. 1	
------------	--------	---

062-099-02	Fig. 2	
------------	--------	---

Trachealhaken
Tracheal Hooks
Ganchos traqueales



Art.Nr.	Beschreibung Description	Size	Spez.
---------	----------------------------	------	-------

16,5cm; 6 4/8"



scharf
sharp
agudo



062-101-01

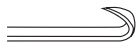

062-101-03

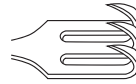

062-101-02

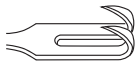

062-101-04



halbscharf
semi-sharp
semi-agudo



062-103-01

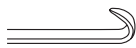

062-103-03



062-103-02



062-103-04

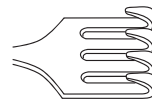

stumpf
blunt
romo



062-102-01



062-102-02



062-102-03



062-102-04

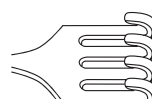

062

Trachealhaken
 Tracheal Hooks
 Ganchos traqueales

Art.Nr. Beschreibung | Description Size Spez.

16,5cm; 6 4/8"



scharf
 sharp
 agudo



062-121-01



062-121-03



062-121-02

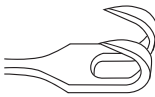

062-121-04

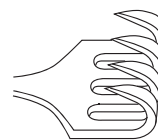

halbscharf
 semi-sharp
 semi-agudo



062-123-01



062-123-03



062-123-02



062-123-04

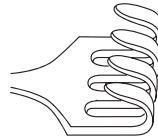

stumpf
 blunt
 romo



062-122-01



062-122-03



062-122-02



062-122-04

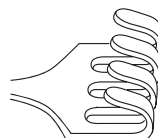

Nervhaken
 Nerv Hooks
 Ganchos para nerviós



Art.Nr. Beschreibung | Description Size Spez.

CUSHING

19,0cm; 7 4/8"



062-140-01

4,0 mm

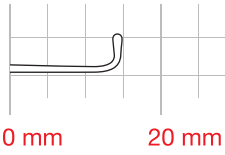

062-140-02

6,0 mm

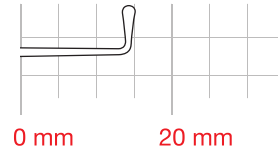

CUSHING

28,0cm; 11"



062-141-01

4,0 mm

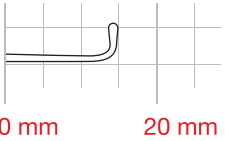

062-141-02

6,0 mm

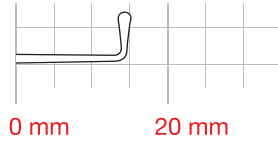

ADSON

20,0cm; 7 7/8"



062-142-20

stumpf
blunt
romo

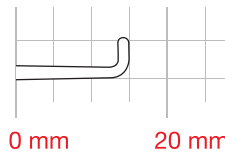

062-143-20

spitz
sharp
agudo

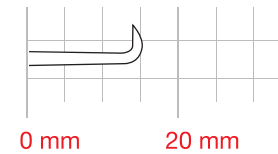

062-144-20

DANDY

21,5cm; 8 4/8"

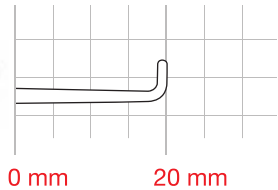

062-145-01

DANDY

21,5cm; 8 4/8"

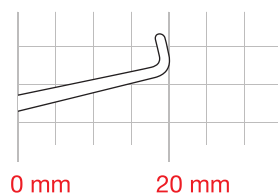

Art.Nr.	Beschreibung Description	Size	Spez.
---------	----------------------------	------	-------

062-145-02	DANDY	21,5cm; 8 4/8"	
------------	-------	----------------	--



	KRAYENBÜHL	18,5cm; 7 2/8"	
--	------------	----------------	--

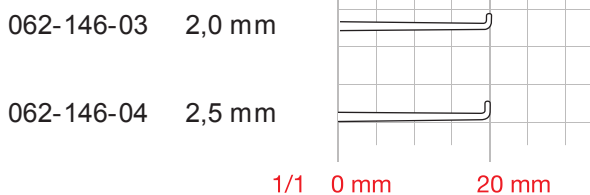
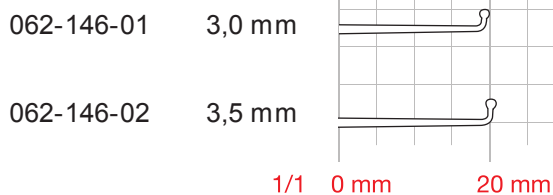

	GRONINGEN	26,0cm; 10 7/8"	
--	-----------	-----------------	--

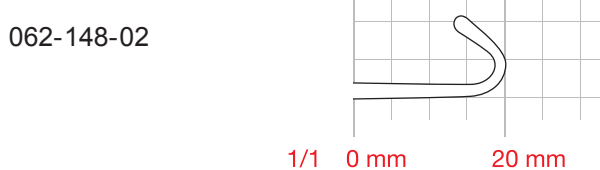
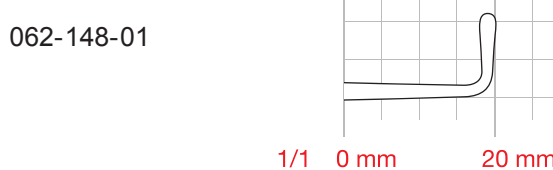

062-149-20	CRILE	20,0cm; 7 7/8"	
------------	-------	----------------	--





Art.Nr.	Beschreibung Description	Size	Spez.
---------	----------------------------	------	-------

MEYERDING

18,0cm; 7 1/8"

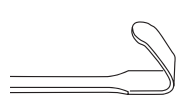
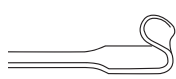

062-150-01	18 x 7 mm 	062-150-04	10 x 3 mm 
062-150-02	16 x 5 mm 	062-150-05	7 x 4 mm 
062-150-03	7 x 4 mm 	062-150-06	4 x 10 mm 

SENN-GREEN

16,0cm; 6 2/8"



062-160-10	10 x 6 mm 	062-160-20	20 x 6 mm 
------------	---	------------	---

LANGENBECK-GREEN

16,0cm; 6 2/8"



062-162-01	16 x 6 mm 	062-162-02	24 x 6 mm 
------------	---	------------	---

062

Art.Nr.	Beschreibung Description	Size	Spez.
---------	----------------------------	------	-------

MINI-LANGENBECK

16,0cm; 6 2/8"



062-164-01

10 x 6 mm



062-164-02

17 x 5 mm

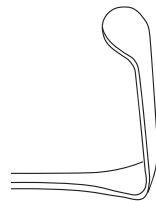

062-164-03

20 x 6 mm

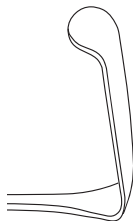







062-164-04

22 x 8 mm

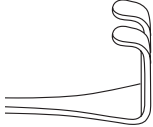

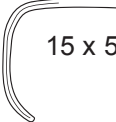
Wundhaken
Retractors
Separadores

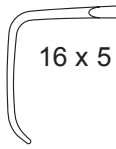

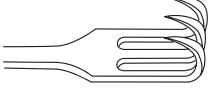
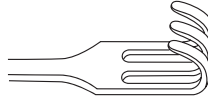
Art.Nr.	Beschreibung Description	Size	Spez.
062-166-16		16,0cm; 6 2/8"	 14 x 8 mm
062-170-14	RAGNELL-DAVIS 	14,0cm; 5 4/8"	 8 x 4 mm  15 x 5,5 mm
062-174-15	RAGNELL 	15,0cm; 5 7/8"	 8 x 3 mm  16 x 5 mm
	SENN-MILLER 	16,0cm; 6 2/8"	
062-180-16	20 x 7 scharf sharp agudo		
062-181-16	20 x 7 stumpf blunt romo		

062

Art.Nr. Beschreibung | Description Size Spez.

DESMARRES

13,0cm; 5 1/8"



062-200-08

8 mm



062-200-14

14 mm



062-200-10

10 mm



062-200-16

16 mm

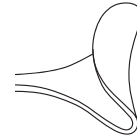

062-200-12

12 mm



062-200-18

18 mm

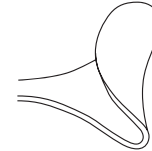

CUSHING

20,0cm; 7 7/8"



062-210-08

8 mm



062-210-14

14 mm

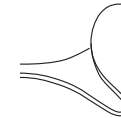

062-210-10

10 mm



062-210-16

16 mm

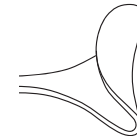

062-210-12

12 mm



062-210-18

18 mm

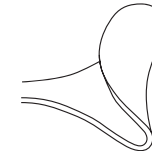



Art.Nr. Beschreibung | Description Size Spez.

CUSHING

24,0cm; 9 4/8"



062-212-08	8 mm		062-212-14	14 mm	
062-212-10	10 mm		062-212-16	16 mm	
062-212-12	12 mm		062-212-18	18 mm	

GIL-VERNET

24,0cm; 9 4/8"



062-230-08	8 mm		062-230-17	17 mm	
062-230-11	11 mm		062-230-20	20 mm	
062-230-13	13 mm		062-230-23	23 mm	
062-230-15	15 mm				

062

Art.Nr.	Beschreibung Description	Size	Spez.
---------	----------------------------	------	-------

062-250-20	CUSHING	20,5cm; 8 1/8"	
------------	---------	----------------	--

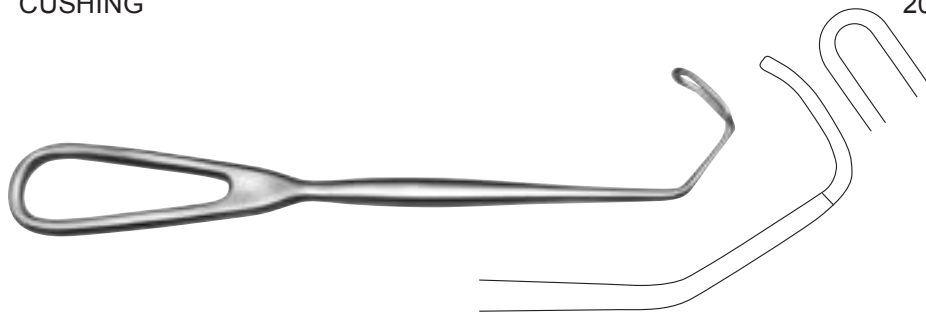

062-300-12	FARABEUF	12,0cm; 4 4/8"	
------------	----------	----------------	--

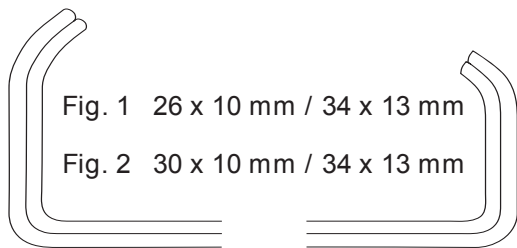

Fig. 1 26 x 10 mm / 34 x 13 mm

Fig. 2 30 x 10 mm / 34 x 13 mm

SET

062-302-15	FARABEUF	15,0cm; 5 7/8"	
------------	----------	----------------	--

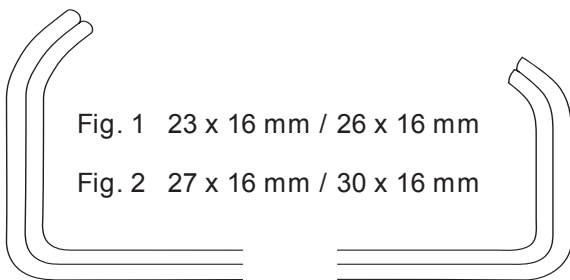

Fig. 1 23 x 16 mm / 26 x 16 mm

Fig. 2 27 x 16 mm / 30 x 16 mm

SET

062-310-00	ROUX Fig.1 - 3	17,0cm; 6 6/8"	
------------	----------------	----------------	--



SET





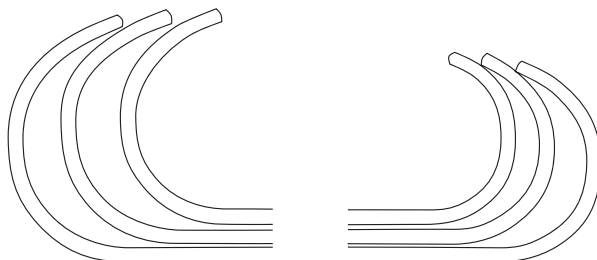

062-310-01	Fig. 1 22 x 21 mm / 27 x 29 mm; 14,5cm; 5 6/8"		
------------	--	--	--

062-310-02	Fig. 2 25 x 26 mm / 30 x 38 mm; 16,0cm; 6 2/8"		
------------	--	--	--

062-310-03	Fig. 3 28 x 29 mm / 33 x 43 mm; 17,0cm; 6 6/8"		
------------	--	--	--



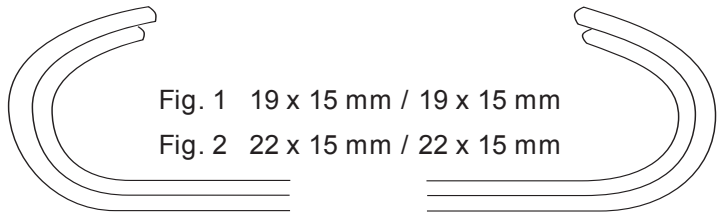

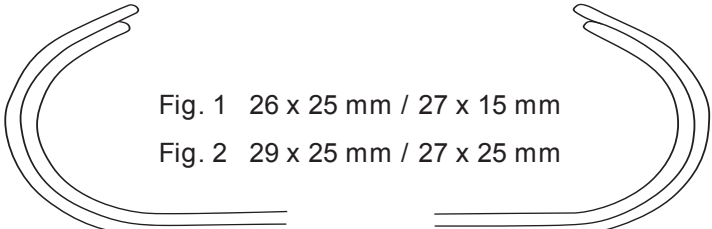
Art.Nr.	Beschreibung Description	Size	Spez.
062-340-06	MINI-ROUX  	14,0cm; 5 4/8"	
062-342-13	BABY-ROUX  	12,5cm; 4 7/8"	
062-350-00	PARKER  	14,0cm; 5 4/8"	SET
062-351-00	PARKER  	18,5cm; 7 2/8"	SET

062

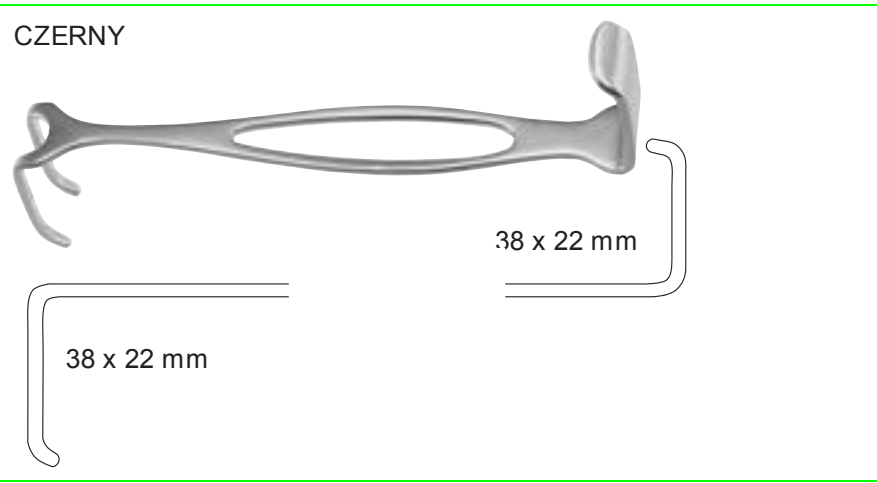
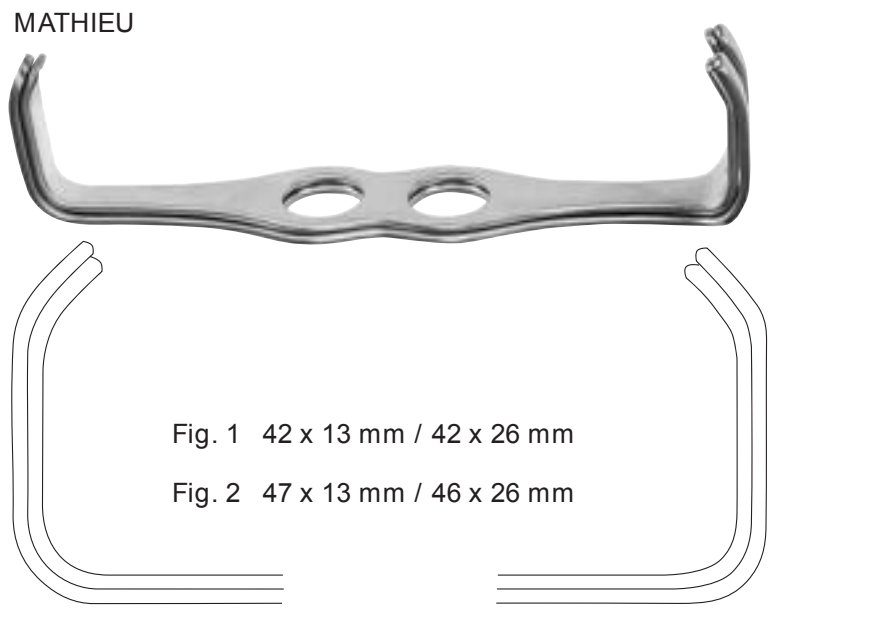
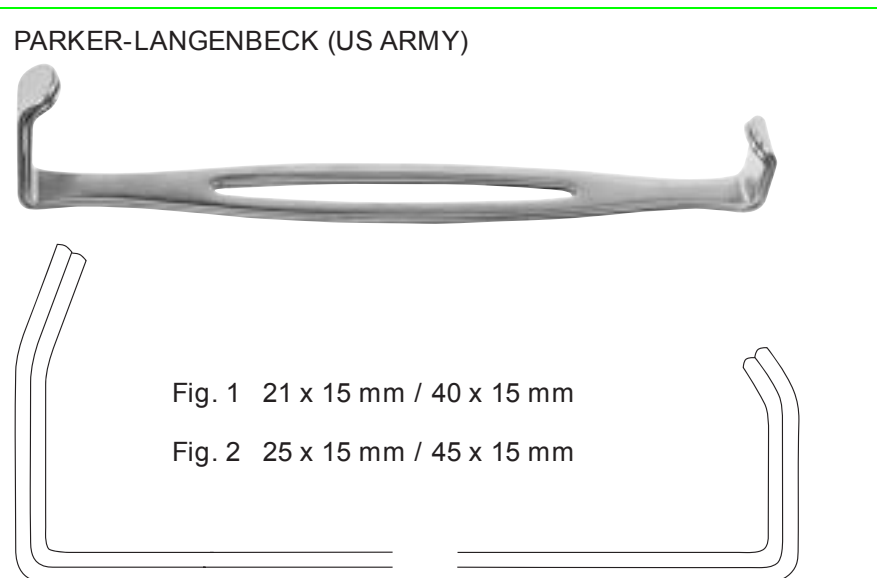
Art.Nr.	Beschreibung Description	Size	Spez.
062-360-00	<p data-bbox="261 448 391 504">CZERNY</p> 	17,5cm; 6 7/8"	
062-380-00	<p data-bbox="261 929 391 985">MATHIEU</p>  <p data-bbox="414 1344 829 1377">Fig. 1 42 x 13 mm / 42 x 26 mm</p> <p data-bbox="414 1400 829 1433">Fig. 2 47 x 13 mm / 46 x 26 mm</p>	20,0cm; 7 7/8"	SET
062-390-00	<p data-bbox="261 1556 734 1612">PARKER-LANGENBECK (US ARMY)</p>  <p data-bbox="414 1926 829 1960">Fig. 1 21 x 15 mm / 40 x 15 mm</p> <p data-bbox="414 1982 829 2016">Fig. 2 25 x 15 mm / 45 x 15 mm</p>	21,0cm; 8 4/8"	SET

Wundhaken
Retractors
Separadores



Art.Nr.	Beschreibung Description	Size	Spez.
062-396-19	GOELET	19,0cm; 7 4/8"	

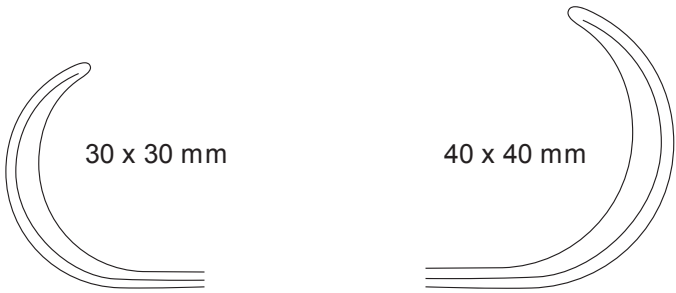

062

Weitere Artikel
further items
más artículos

Art.Nr.	Beschreibung Description	Size	Spez.
Other items available but not illustrated			
062-048-18	GILLIES Skin Hook; sharp	18,0cm; 7,2"	
062-063-15	TOENNIS Hook; sharp	15,0cm; 6"	
062-084-16	KNAPP Hook; 4 teeth; sharp	16,0cm; 6,4"	
062-085-02	fine Hook; 2 teeth	13,5cm; 5,4"	
	Hook	16,5cm; 6,6"	
062-111-01	1 teeth; sharp; serrated handle		
062-111-02	2 teeth; sharp; serrated handle		
062-111-03	3 teeth; sharp; serrated handle		
062-111-04	4 teeth; sharp; serrated handle		
062-112-01	1 teeth; blunt; serrated handle		
062-112-02	2 teeth; blunt; serrated handle		
062-112-03	3 teeth; blunt; serrated handle		
062-112-04	4 teeth; blunt; serrated handle		
	BABY SENN-MILLER Retractor	15,0cm; 6"	
062-178-15	3 teeth; sharp; double ended		
062-179-15	3 teeth; blunt; double ended		
062-184-18	COPE Retractor; double ended	18,0cm; 7,2"	
	DESMARRES Retractor	16,0cm; 6,4"	
062-204-08	8mm width of blade		
062-204-10	10mm width of blade		
062-204-12	12mm width of blade		
062-204-14	14mm width of blade		
062-204-16	16mm width of blade		
062-204-18	18mm width of blade		
	CUSHING Vein Retractor	25,0cm; 10"	
062-216-14	11X14mm; with hollow handle		
062-216-18	13X18mm; with hollow handle		
062-216-22	15X22mm; with hollow handle		
	TAYLOR Spinal Retractor	16,5cm; 6,6"	
062-252-07	75X30mm		
062-252-10	100X30mm		
	FARABEUF Retractor	12,0cm; 4,8"	
062-300-01	Fig. 1; 30X10 and 30X13mm		
062-300-02	Fig. 2; 26X10 and 34X13mm		
	FARABEUF Retractor	15,0cm; 6"	
062-302-01	Fig. 1; 23X16 and 26X16mm		
062-302-02	Fig. 2; 27X16 and 30X16mm		

Weitere Artikel
further items
más artículos



Art.Nr.	Beschreibung Description	Size	Spez.
Other items available but not illustrated			
062-304-15	COLLIN Retractor; Set	15,0cm; 6"	
062-310-04	ROUX Retractor Fig. 4; 29X24 and 45X28mm	18,0cm; 7,2"	
062-320-01 062-320-02 062-320-03	HEANEY Retractor Fig. 1; 45X25mm Fig. 2; 73X28mm Fig. 3; 82X28mm	27,0cm; 10,8"	
062-322-01 062-322-02 062-322-03	HEANEY Retractor Fig. 1; 45X25mm Fig. 2; 73X28mm Fig. 3; 82X28mm	16,5cm; 6,6"	
062-330-01	ROUX Retractor Fig. 1; s-curved	14,0cm; 5,6"	
062-350-01 062-350-02	PARKER Retractor Fig. 1; 19X15 and 19X15mm Fig. 2; 22X15 and 22X15mm	13,5cm; 5,4"	
062-351-01 062-351-02	PARKER Retractor Fig. 1 Fig. 2	18,0cm; 7,2"	
062-370-16 062-370-20 062-370-25	CANNY RYAL retractor 16x25mm 19x28mm 25x32mm	19,0cm; 7,5"	
062-380-01 062-380-02	MATHIEU Retractor Fig. 1; 42X13 and 42X26mm Fig. 2; 47X13 and 46X26mm	20,0cm; 8"	
062-390-01 062-390-02	PARKER-LANGENBECK Retractor Fig. 1; 21X24 and 40X15mm Fig. 2; 25X24 and 45X15mm	21,0cm; 8,4"	

062

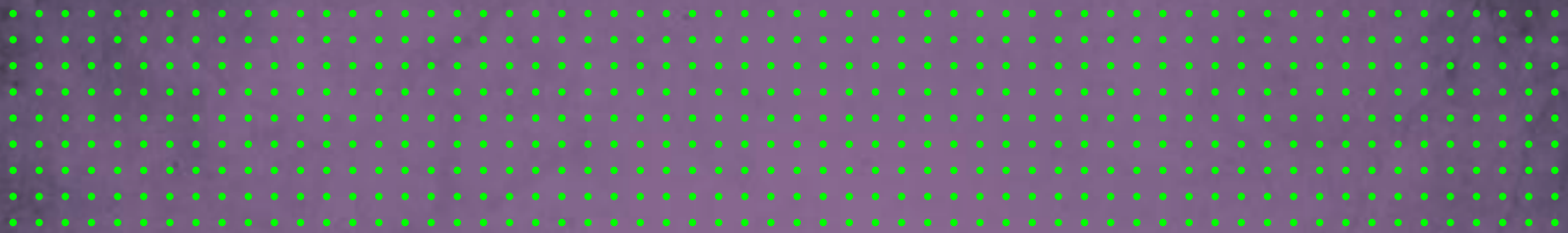

skin retractor

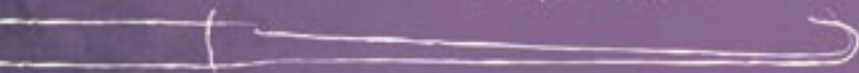

vein retractor



tracheal hooks



Wundhaken
Retractors

064





Art.Nr. Beschreibung | Description Size Spez.

VOLKMANN

22,0cm; 8 5/8"



scharf | sharp | agudo

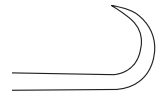

064-001-01



064-001-04



064-001-02



064-001-06



064-001-03



064-001-08

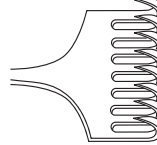

stumpf | blunt | romo

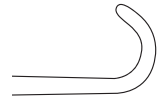

064-002-01



064-002-04



064-002-02



064-002-06

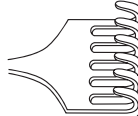

064-002-03

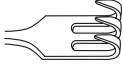

064-002-08

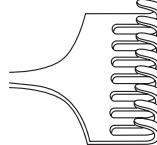

halbscharf | semi-sharp | semi-agudo

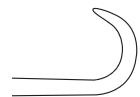

064-003-01



064-003-04



064-003-02



064-003-06

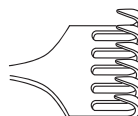

064-003-03



064-003-08

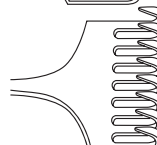

064

Art.Nr. Beschreibung | Description Size Spez.

KOCHER

22,0cm; 8 5/8"



scharf | sharp | agudo

064-011-01



064-011-04

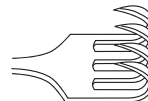

064-011-02

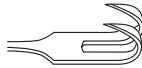

064-011-06

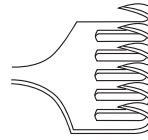

064-011-03



064-011-08

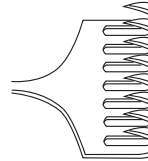

stumpf | blunt | romo

064-012-01



064-012-04



064-012-02



064-012-06

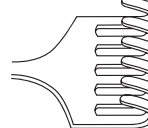

064-012-03



064-012-08

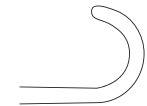
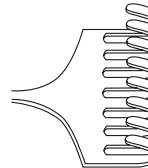

halbscharf | semi-sharp | semi-agudo

064-013-01



064-013-04



064-013-02



064-013-06

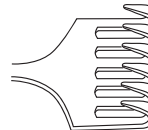

064-013-03



064-013-08

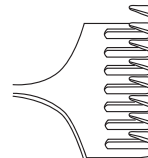

Wundhaken
Retractors
Separadores



Art.Nr.	Beschreibung Description	Size	Spez.
---------	----------------------------	------	-------

VOLKMANN

21,5cm; 8 4/8"



064-004-01

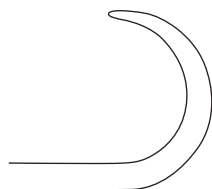

064-005-01

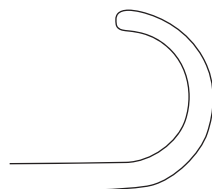

064-006-01

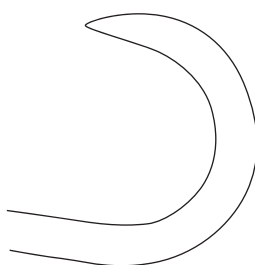

064

Art.Nr.	Beschreibung Description	Size	Spez.
---------	----------------------------	------	-------

KOERTE

24,5cm; 9 5/8"



064-021-24

26 x 40 mm

scharf
sharp
agudo

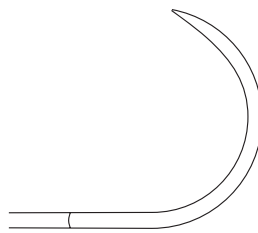

064-022-24

26 x 40 mm

stumpf
blunt
romo

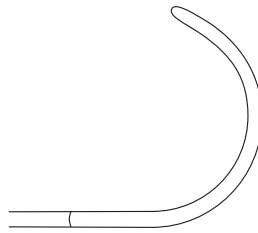

064-027-02

WASSMUND

22,5cm; 8 7/8"

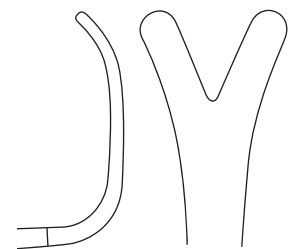

33 x 20 mm



Art.Nr. Beschreibung | Description Size Spez.

OLLIER

24,5cm; 9 5/8"



064-028-30
36 x 30 mm

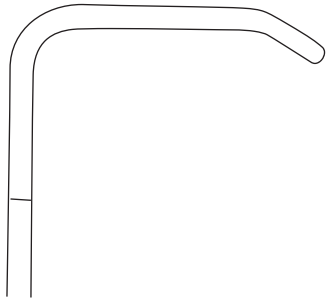

064-028-60
36 x 60 mm

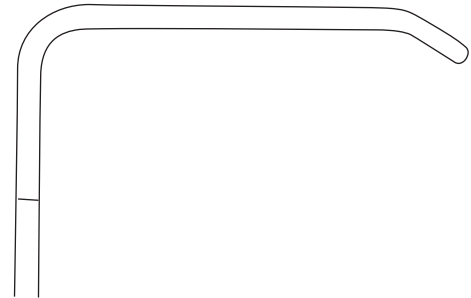

ISRAEL

24,5cm; 9 5/8"



064-032-04

40 x 40 mm

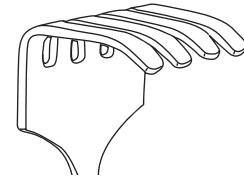
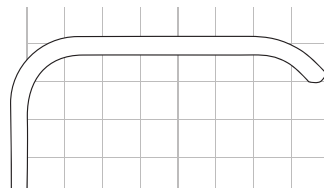

064-032-05

45 x 50 mm

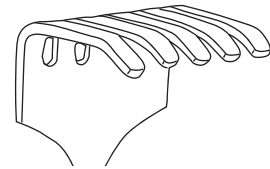
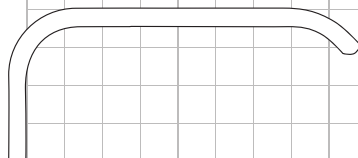

064-032-06

50 x 60 mm

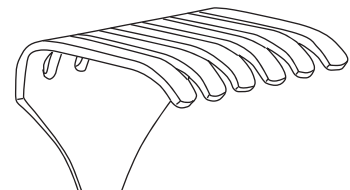
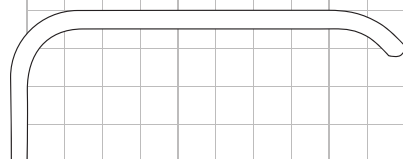

064-032-07

70 x 70 mm

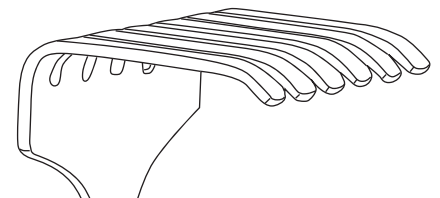
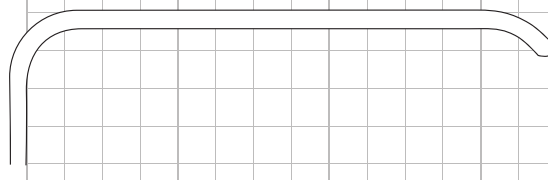

1/1 0 mm 20 mm 40 mm 60 mm

064

Art.Nr.	Beschreibung Description	Size	Spez.
---------	----------------------------	------	-------

LANGENBECK

21,0cm; 8 2/8"



064-100-55

55 x 20 mm

064-100-60

60 x 20 mm

064-100-63

63 x 20 mm

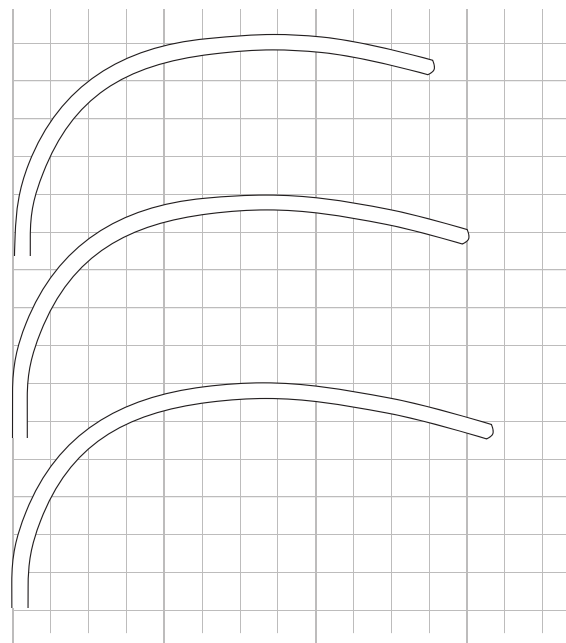

1/1 0 mm 20 mm 40 mm 60 mm

064-115-65

LANGENBECK

21,0cm; 8 2/8"

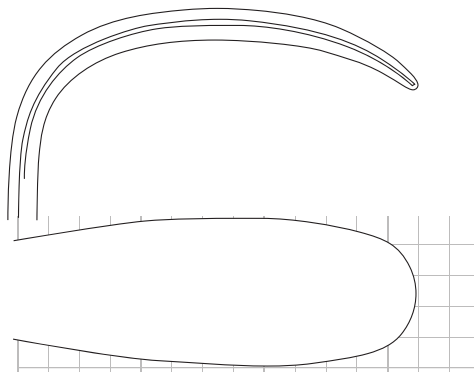

1/1 0 mm 20 mm 40 mm 60 mm

65 x 20 mm



Art.Nr.	Beschreibung Description	Size	Spez.
064-125-85	LANGENBECK	22,5cm; 8 7/8"	

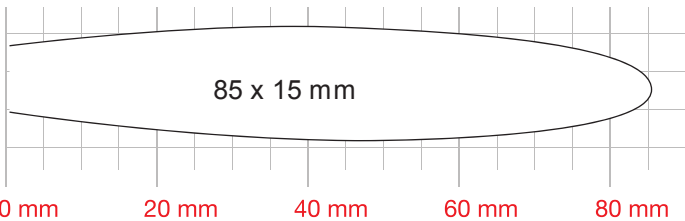
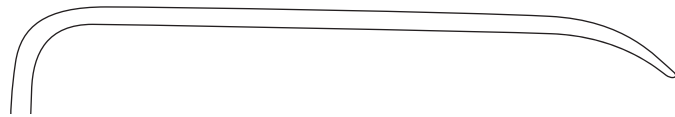

1/1 0 mm 20 mm 40 mm 60 mm 80 mm

064-160-19	LAHEY	19,5cm; 7 5/8"	
------------	-------	----------------	--

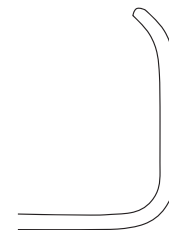

28 x 6 mm

064-164-20	LITTLE	20,0cm; 8"	
------------	--------	------------	--

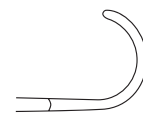

12 x 14 mm

064

Art.Nr.	Beschreibung Description	Size	Spez.
	LANGENBECK	22,0cm; 8 5/8"	



064-110-30

30 x 11 mm

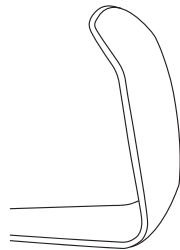

064-110-40

40 x 11 mm

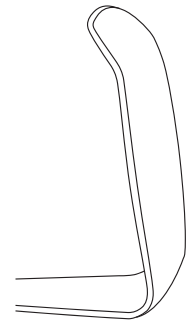

064-110-31

30 x 14 mm

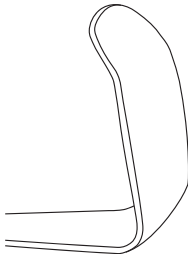

064-110-32

30 x 16 mm

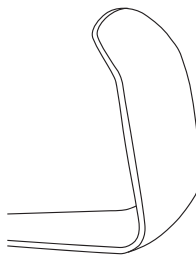

064-110-50

50 x 11 mm

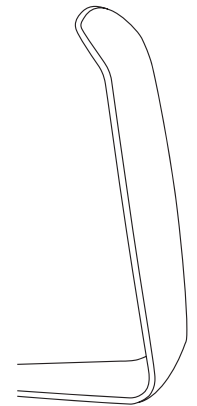

Wundhaken
 Retractors
 Separadores



Art.Nr.	Beschreibung Description	Size	Spez.
---------	----------------------------	------	-------

LANGENBECK

22,0cm; 8 5/8"



064-120-30

30 x 11 mm

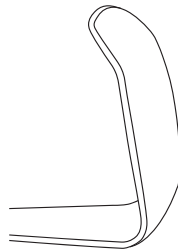

064-120-40

40 x 11 mm

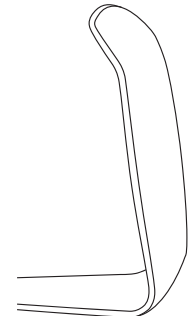

064-120-31

30 x 14 mm

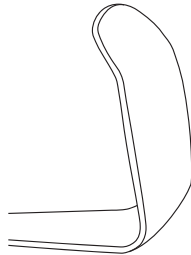

064-120-32

30 x 16 mm

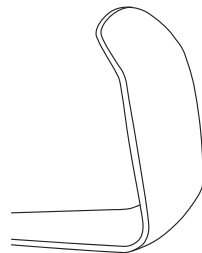

064-120-50

50 x 11 mm

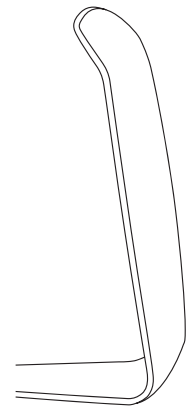

064

Art.Nr. Beschreibung | Description Size Spez.

KOCHER-LANGENBECK

21,5cm; 8 4/8"

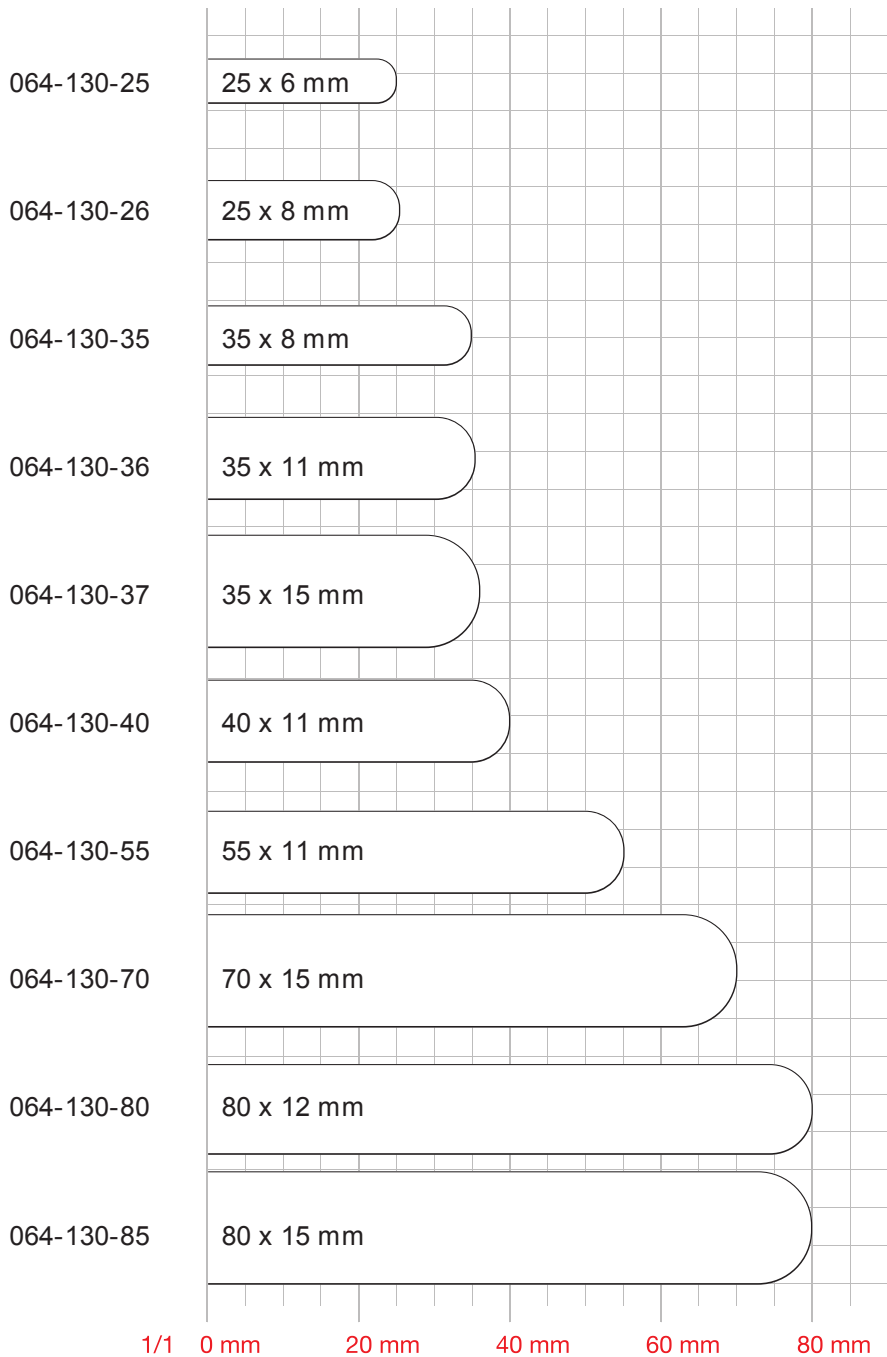

1/1 0 mm 20 mm 40 mm 60 mm 80 mm

Wundhaken
 Retractors
 Separadores



Art.Nr.	Beschreibung Description	Size	Spez.
---------	----------------------------	------	-------

KOCHER

23,0cm ; 9"

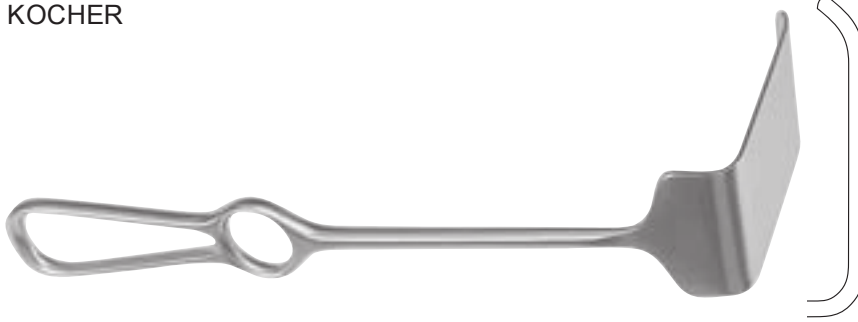

064-140-18

40 x 18 mm

064-140-20

60 x 20 mm

064-140-25

60 x 25 mm

064-140-30

75 x 30 mm

064-140-40

75 x 40 mm

1/1 0 mm 20 mm 40 mm 60 mm 80 mm

064

Art.Nr.	Beschreibung Description	Size	Spez.
---------	----------------------------	------	-------

SAUERBRUCH

22,5cm; 8 7/8"

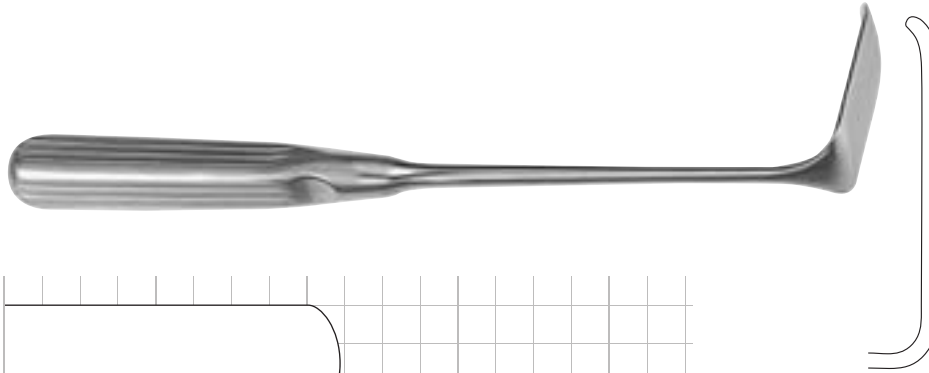

064-150-44

44 x 16 mm

064-150-55

55 x 22 mm

064-150-72

72 x 19 mm

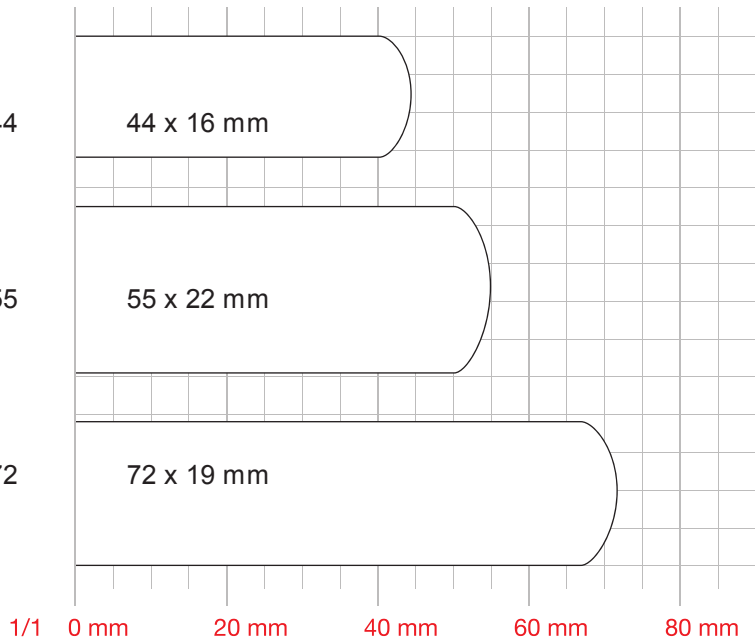

KOCHER

21,5cm; 8 4/8"



064-170-01

22 x 12 mm

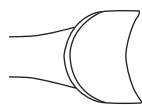

064-170-02

24 x 14 mm

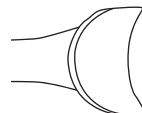



Art.Nr.	Beschreibung Description	Size	Spez.
KOCHER			
064-175-01	22,0cm; 8 5/8" 40 x 10 mm	064-175-03	23,0cm; 9" 40 x 20 mm
064-175-02	23,0cm; 9" 40 x 15 mm		
MIDDELDORPF			
064-180-01	22,0cm; 8 5/8" 14 x 17 mm	064-180-03	24,0cm; 9 4/8" 26 x 31 mm
064-180-02	23,0cm; 9" 20 x 22 mm		
MIDDELDORPF			
064-182-01	22,0cm; 8 5/8" 14 x 17 mm	064-182-03	24,0cm; 9 4/8" 26 x 31 mm
064-182-02	23,0cm; 9" 20 x 22 mm		

064

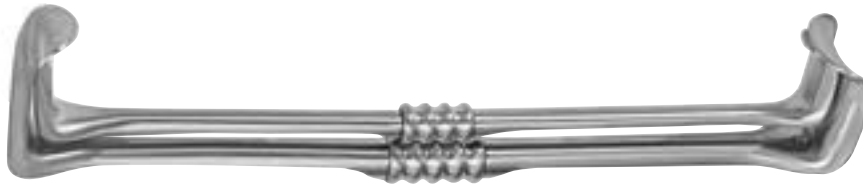

Art.Nr.	Beschreibung Description	Size	Spez.
064-200-00	RICHARDSON-EASTMAN Fig. 1 - 2	28,0cm; 11"	SET



064-200-01	Fig. 1: 25x20mm / 30x28mm; 26,0cm; 10 2/8"
064-200-02	Fig. 2: 43x38mm / 63x44mm; 28,0cm; 11"

	RICHARDSON (KELLY)	24,0cm; 9 4/8"
--	--------------------	----------------

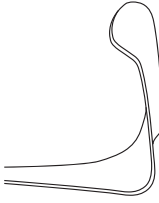

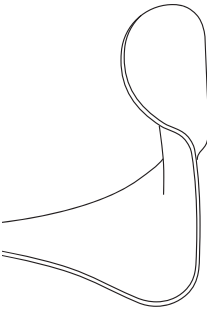
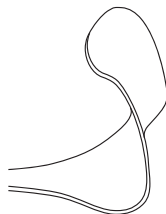
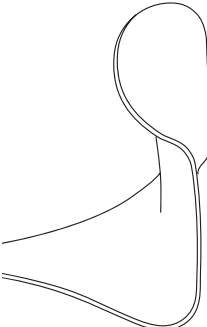
064-210-02	28 x 20 mm		064-210-05	52 x 22 mm	
064-210-03	36 x 28 mm		064-210-06	65 x 50 mm	
064-210-04	44 x 38 mm		064-210-07	70 x 65 mm	



Art.Nr.	Beschreibung Description	Size	Spez.
064-230-50	DOYEN	24,0cm; 9 4/8"	



50 x 85 mm

064-250-70	KOCHER	23,5cm; 9 2/8"	
------------	--------	----------------	--

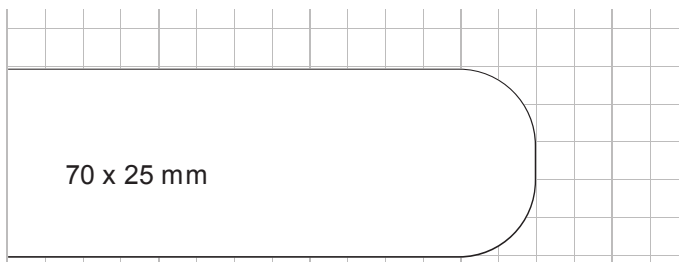

1/1 0 mm 20 mm 40 mm 60 mm 80 mm

064

Art.Nr.	Beschreibung Description	Size	Spez.
---------	----------------------------	------	-------

KOCHER

25,0cm; 9 7/8"



064-250-81

80 x 42 mm

064-250-82

80 x 50 mm

064-250-83

80 x 60 mm

1/1 0 mm 20 mm 40 mm 60 mm 80 mm



Art.Nr.	Beschreibung Description	Size	Spez.
	FRITSCH	24,0cm; 9 4/8"	

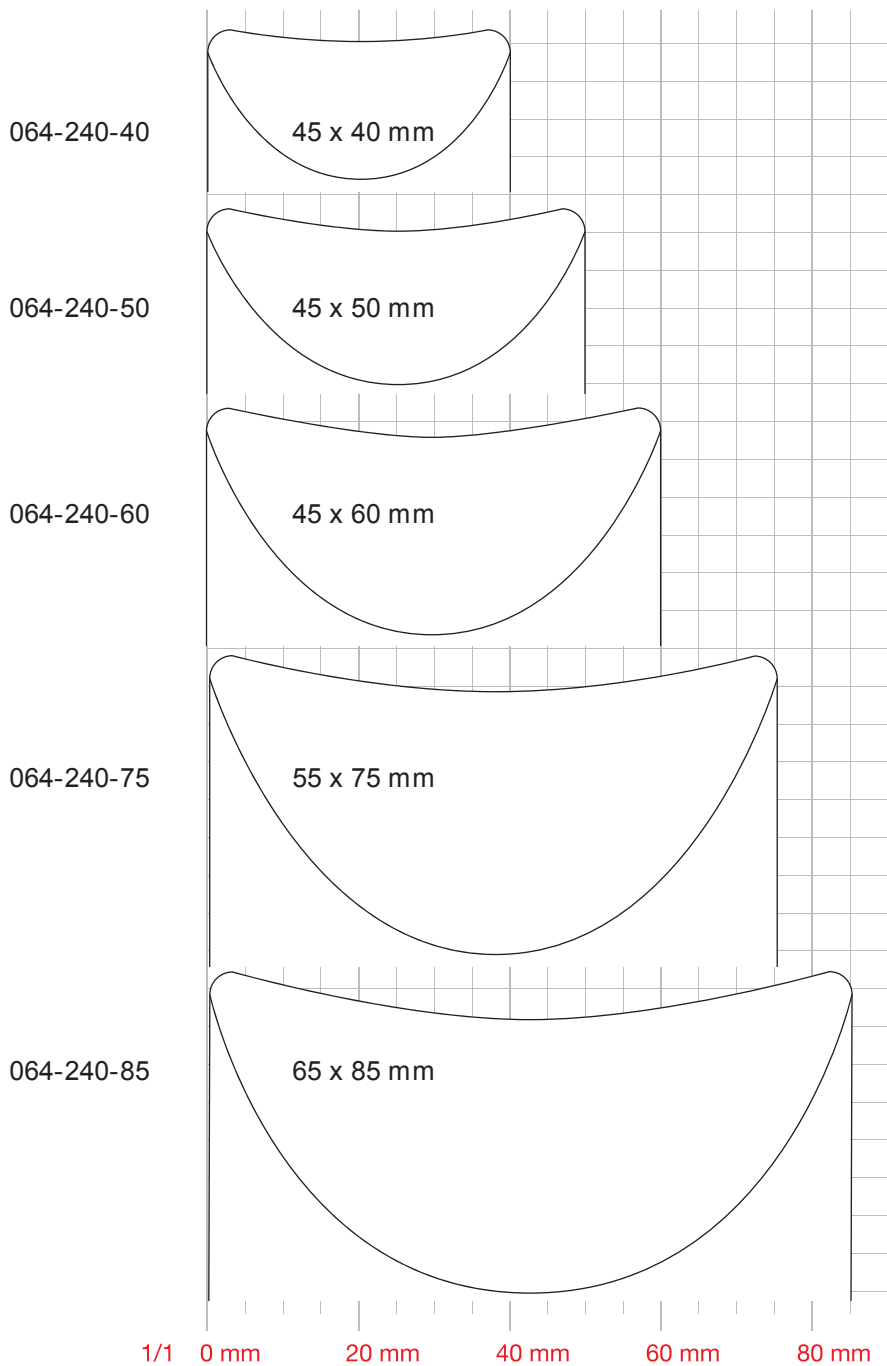

064

1/1 0 mm 20 mm 40 mm 60 mm 80 mm

Art.Nr.	Beschreibung Description	Size	Spez.
---------	----------------------------	------	-------

SIMON

28,0cm; 11"



064-260-01

115 x 22 mm

064-260-02

115 x 27 mm

1/1 0 mm 20 mm 40 mm 60 mm 80 mm 100 mm 120 mm

064-264-25

MARTIN

26,5cm; 10 3/8"

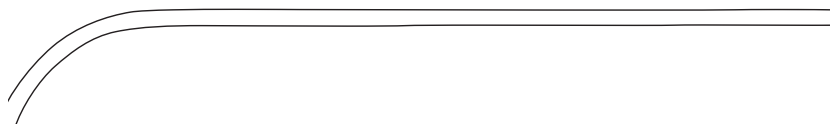

110 x 27 mm

1/1 0 mm 20 mm 40 mm 60 mm 80 mm 100 mm 120 mm



Art.Nr.	Beschreibung Description	Size	Spez.
064-394-25	SAUERBRUCH	25,5cm; 10"	

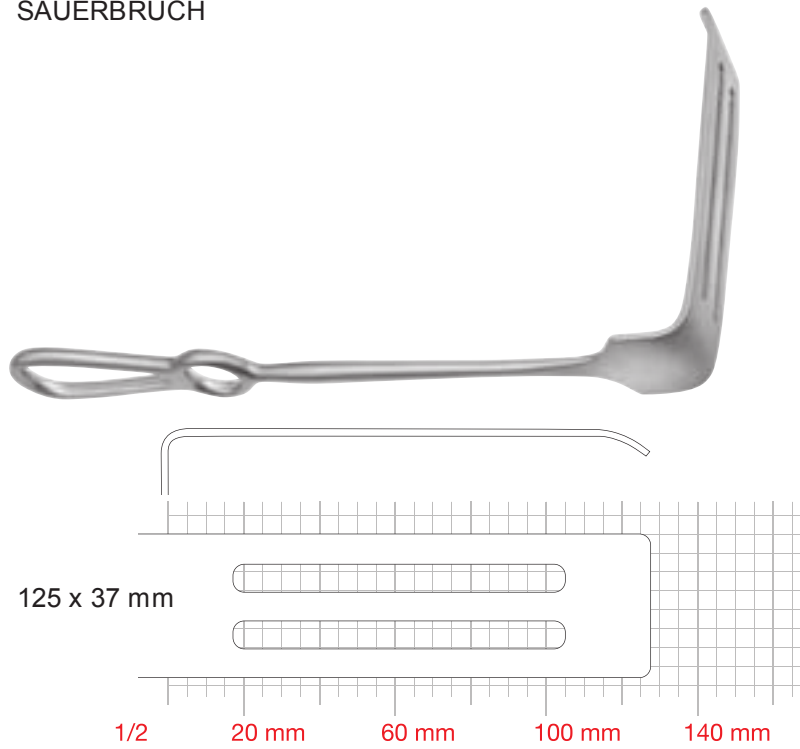

064-272-90	MIKULICZ	26,0cm; 10 7/8"	
------------	----------	-----------------	--

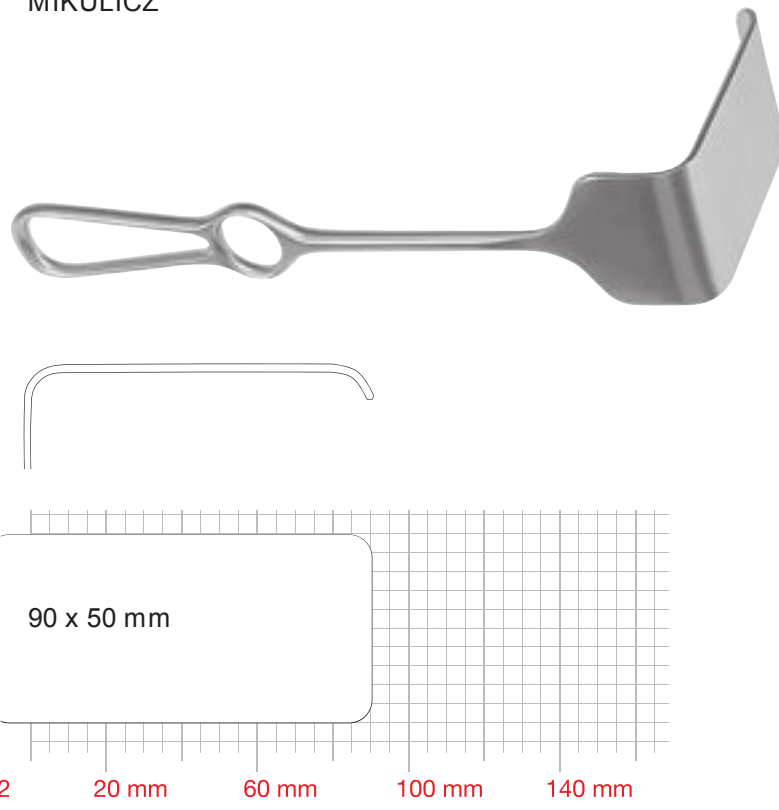

064

Art.Nr.	Beschreibung Description	Size	Spez.
---------	----------------------------	------	-------

MIKULICZ

25,0cm; 9 7/8"

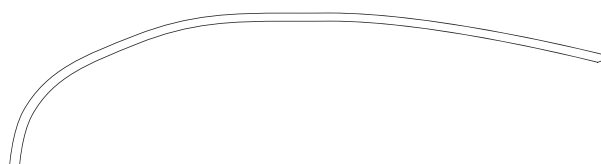

064-274-01

85 x 35 mm

064-274-02

120 x 50 mm

064-274-03

150 x 50 mm

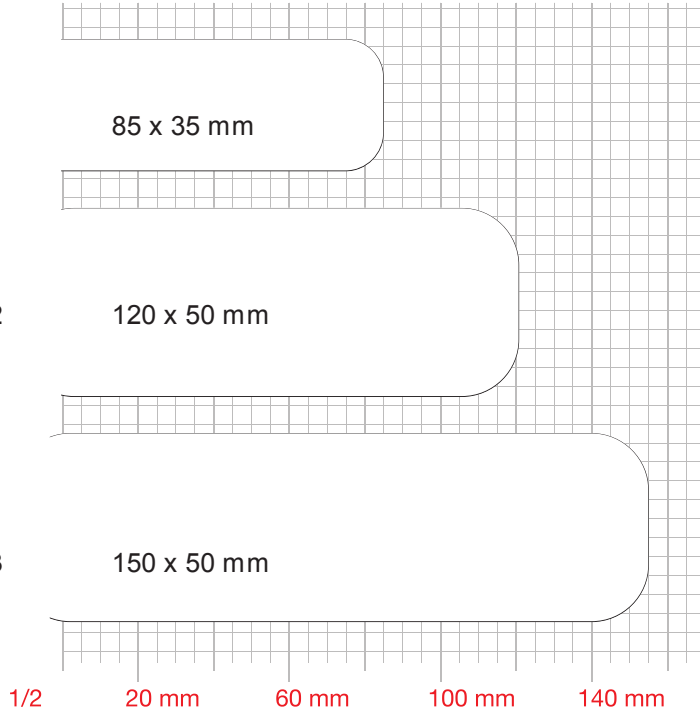

Wundhaken
Retractors
Separadores



Art.Nr.	Beschreibung Description	Size	Spez.
---------	----------------------------	------	-------

KELLY

28,0cm; 11"

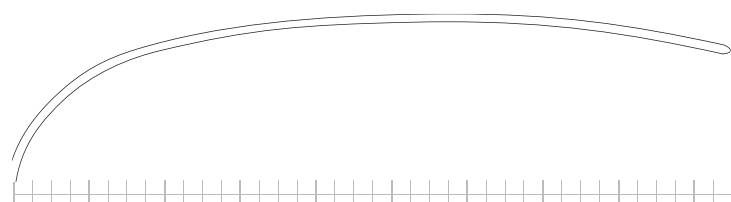

064-280-61

160 x 38 mm

064-280-62

160 x 57 mm

064-280-91

190 x 38 mm

064-280-92

190 x 57 mm

1/2 20 mm 60 mm 100 mm 140 mm 180 mm

064

Art.Nr. Beschreibung | Description Size Spez.

ZENKER

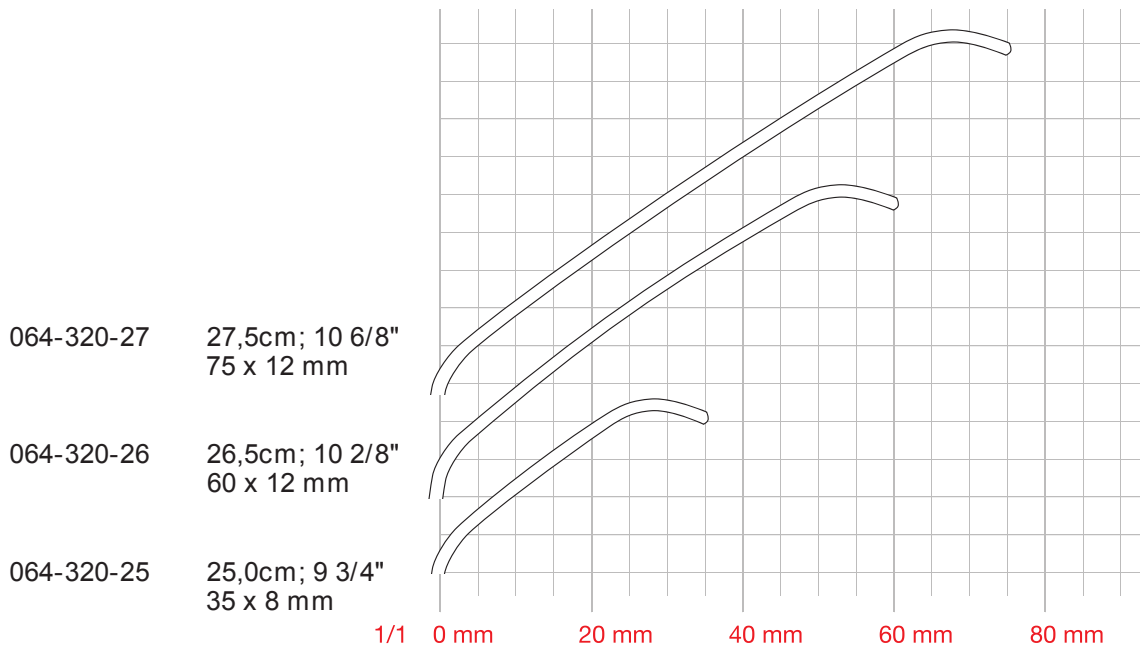

MEYERDING

22,5cm; 8 7/8"

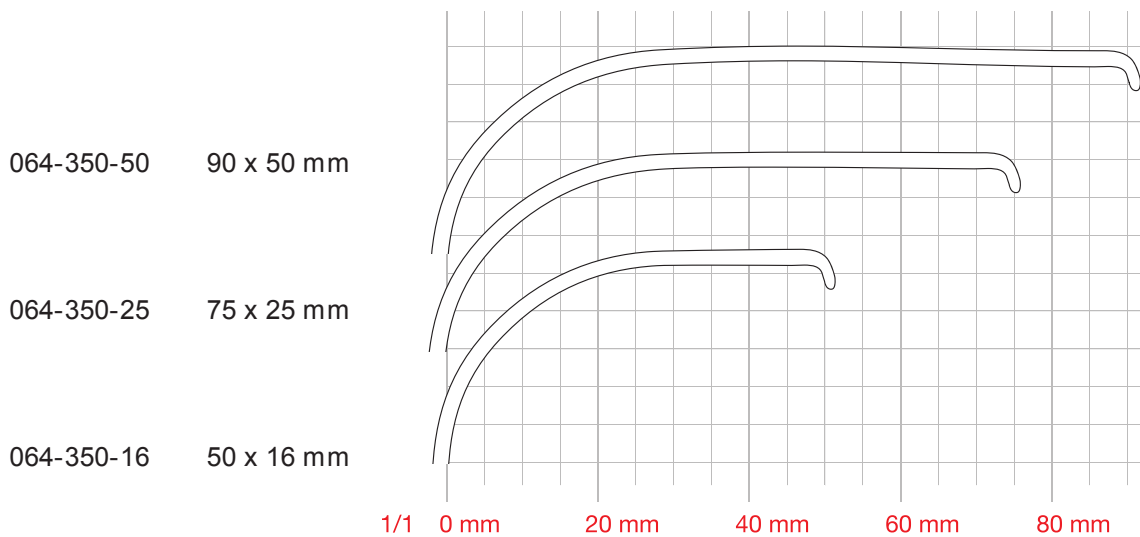

Wundhaken
Retractors
Separadores



Art.Nr.	Beschreibung Description	Size	Spez.
	CORYLLOS	24,0cm; 9 4/8"	

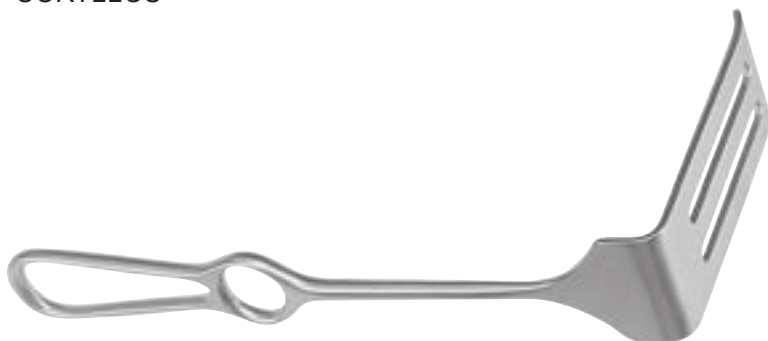

064-390-01

82 x 22 mm

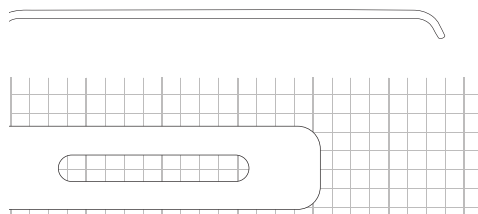

064-390-02

108 x 43 mm

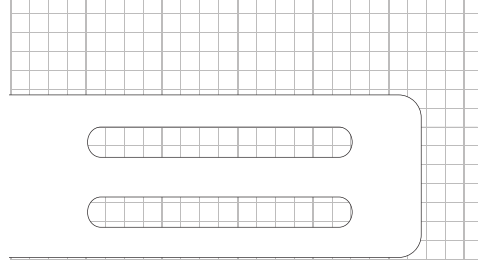

064-390-03

115 x 65 mm

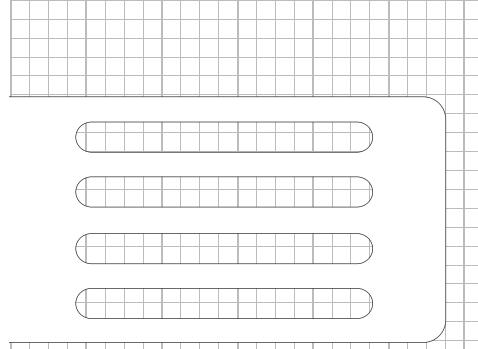

1/2 20 mm 60 mm 100 mm

064

Art.Nr.	Beschreibung Description	Size	Spez.
	BRUNNER	25,5cm; 10"	

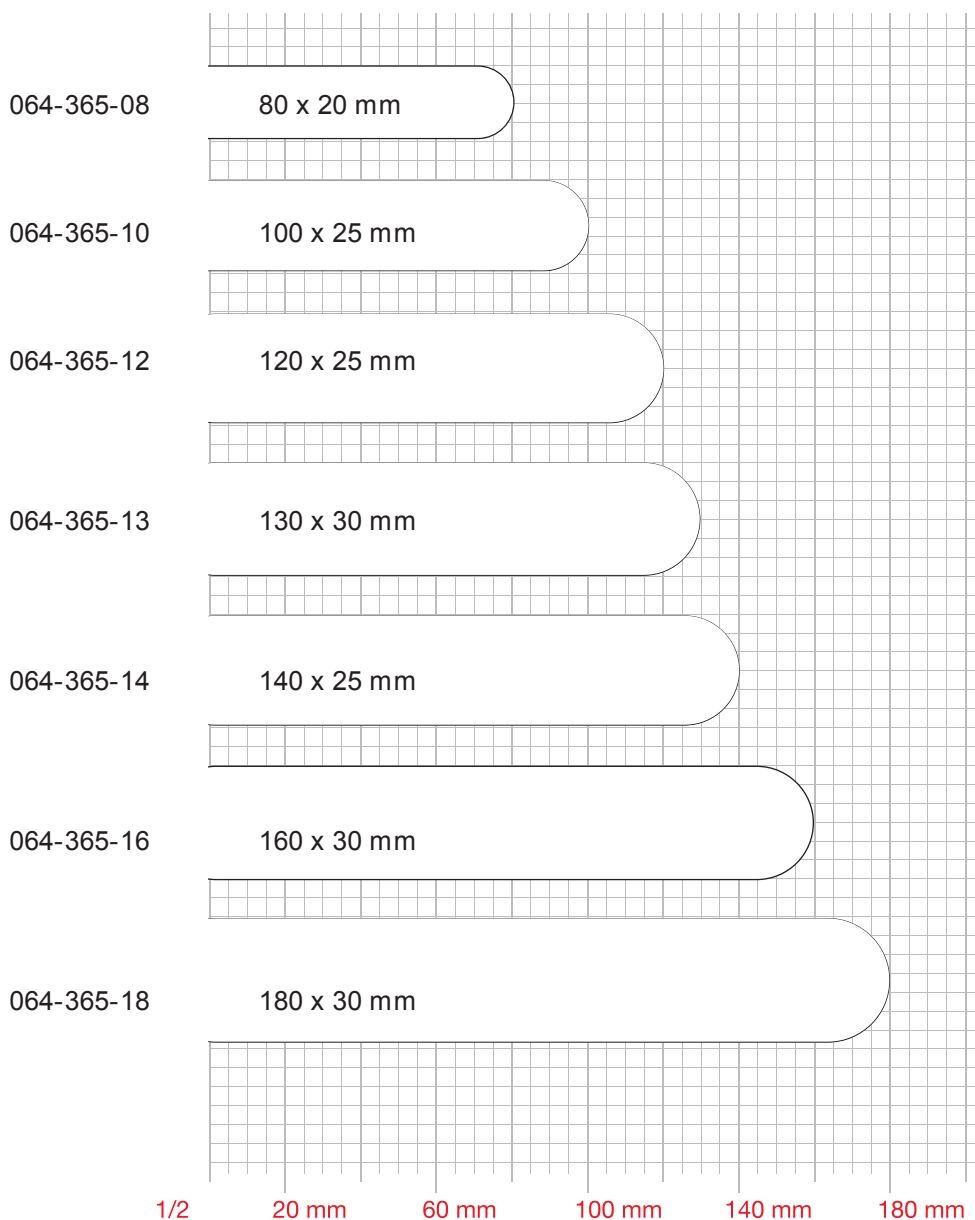

Wundhaken
Retractors
Separadores



Art.Nr.	Beschreibung Description	Size	Spez.
	BRUNNER	25,5cm; 10"	



064-370-08

80 x 20 mm

064-370-10

100 x 20 mm

064-370-12

120 x 25 mm

064-370-14

140 x 25 mm

064-370-16

160 x 30 mm

064-370-18

180 x 30 mm

1/2 20 mm 60 mm 100 mm 140 mm 180 mm

064

Art.Nr.	Beschreibung Description	Size	Spez.
---------	----------------------------	------	-------

HARRINGTON

33,0cm; 13"



064-500-62

127 x 62 mm

064-500-40

127 x 40 mm

1/1 0 mm 20 mm 40 mm 60 mm 80 mm 100 mm 120 mm 140 mm



Art.Nr.	Beschreibung Description	Size	Spez.
---------	----------------------------	------	-------

DEAVER

064-602-18

18,0cm; 7 7/8"
19,0 mm



064-602-22

21,5cm; 8 4/8"
22,0 mm



064-602-23

23,0cm; 9 5/8"
25,0 mm



064

Art.Nr.	Beschreibung Description	Size	Spez.
---------	----------------------------	------	-------

DEAVER

064-604-30

30,5cm; 12"
25,0 mm



064-604-33

33,5cm; 13 2/8"
25,0 mm



064-604-36

34,5cm; 13 5/8"
25,0 mm





Art.Nr.	Beschreibung Description	Size	Spez.
---------	----------------------------	------	-------

DEAVER

064-610-38

32,0cm; 12 5/8"
 38,0 mm



064-610-50

31,5cm; 12 3/8"
 50,0 mm



064-610-75

31,5cm; 12 3"
 75,0 mm



064

Art.Nr.	Beschreibung Description	Size	Spez.
	DEAVER GRIP	31,5cm; 12 3/8"	

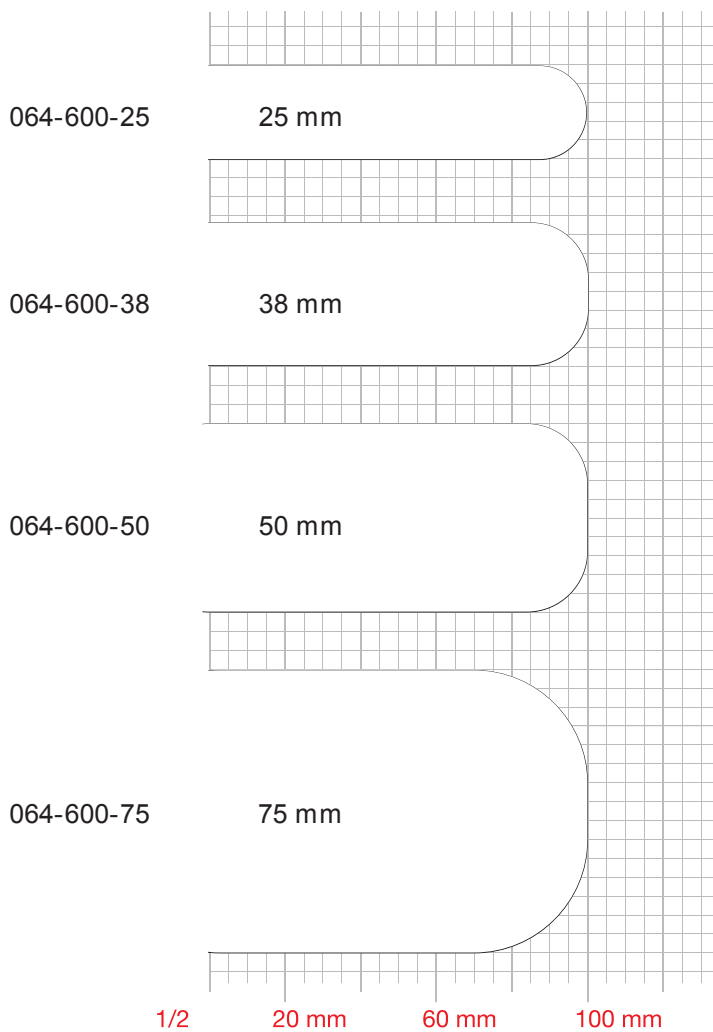

Wundhaken
Retractors
Separadores



Art.Nr.	Beschreibung Description	Size	Spez.
064-622-31	KÜMMEL	31,0cm; 12 2/8"	

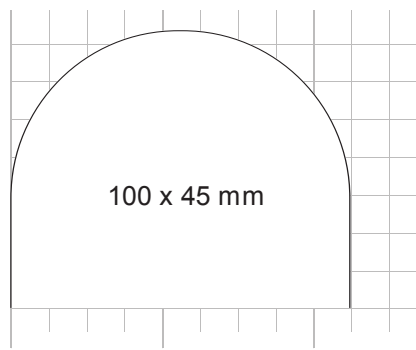

1/1 0 mm 20 mm 40 mm

064-700-30	ALLISON	Lungenspatel Lung spatula Espátula para el pulmón	29,5cm; 11 5/8" 40 mm
------------	---------	---	--------------------------



064-700-32	ALLISON	Lungenspatel Lung spatula Espátula para el pulmón	33,0cm; 13" 54 mm
------------	---------	---	----------------------



064

Art.Nr.	Beschreibung Description	Size	Spez.
	DAVIDSON Scapula-Haken Scapula retractor Separador para scápula	19,0cm; 7 4/8"	

064-710-50 75 x 50 mm

064-710-90 75 x 90 mm



CRAWFORD	Aortahaken Aorta Retractors Separadores para áorta	19,0cm; 7 4/8"	
----------	--	----------------	--

064-808-01 15 x 15 mm

064-808-02 15 x 23 mm



Atriumhaken
 Atrium Retractor
 Separador para altrio



Art.Nr.	Beschreibung Description	Size	Spez.
---------	----------------------------	------	-------

064-806-01	COOLEY rechts right derecho	25,0cm; 9 7/8"	
------------	--------------------------------------	----------------	--



064-806-02	COOLEY rechts; gerieft right; serrated derecho; estriado	25,0cm; 9 7/8"	
------------	---	----------------	--



064-806-03	COOLEY links left izquierdo	27,5cm; 10 7/8"	
------------	--------------------------------------	-----------------	--



064

Peluishaken
 Peluis Retractor
 Separadores para peluis

Art.Nr.	Beschreibung Description	Size	Spez.
---------	----------------------------	------	-------

ST MARKS



064-720-02 33,0cm; 13"

180 x 60 mm

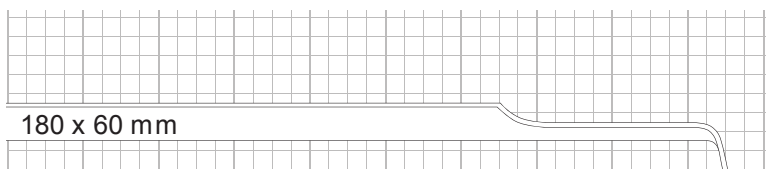

064-721-02 33,0cm; 13"

180 x 60 mm

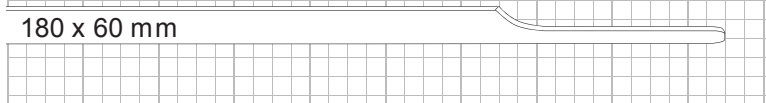

064-720-01 29,0cm; 11 1/2"

130 x 60 mm

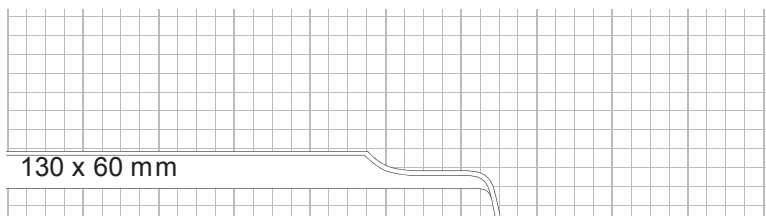

064-721-01 29,0cm; 11 1/2"

130 x 60 mm

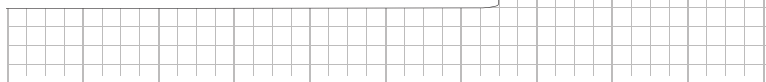

1/2 20 mm 60 mm 100 mm 140 mm 180 mm

064

Aortahaken
Aorta Retractors
Separadores para aorta



Art.Nr.	Beschreibung Description	Size	Spez.
	ROSS	25,5cm; 10"	

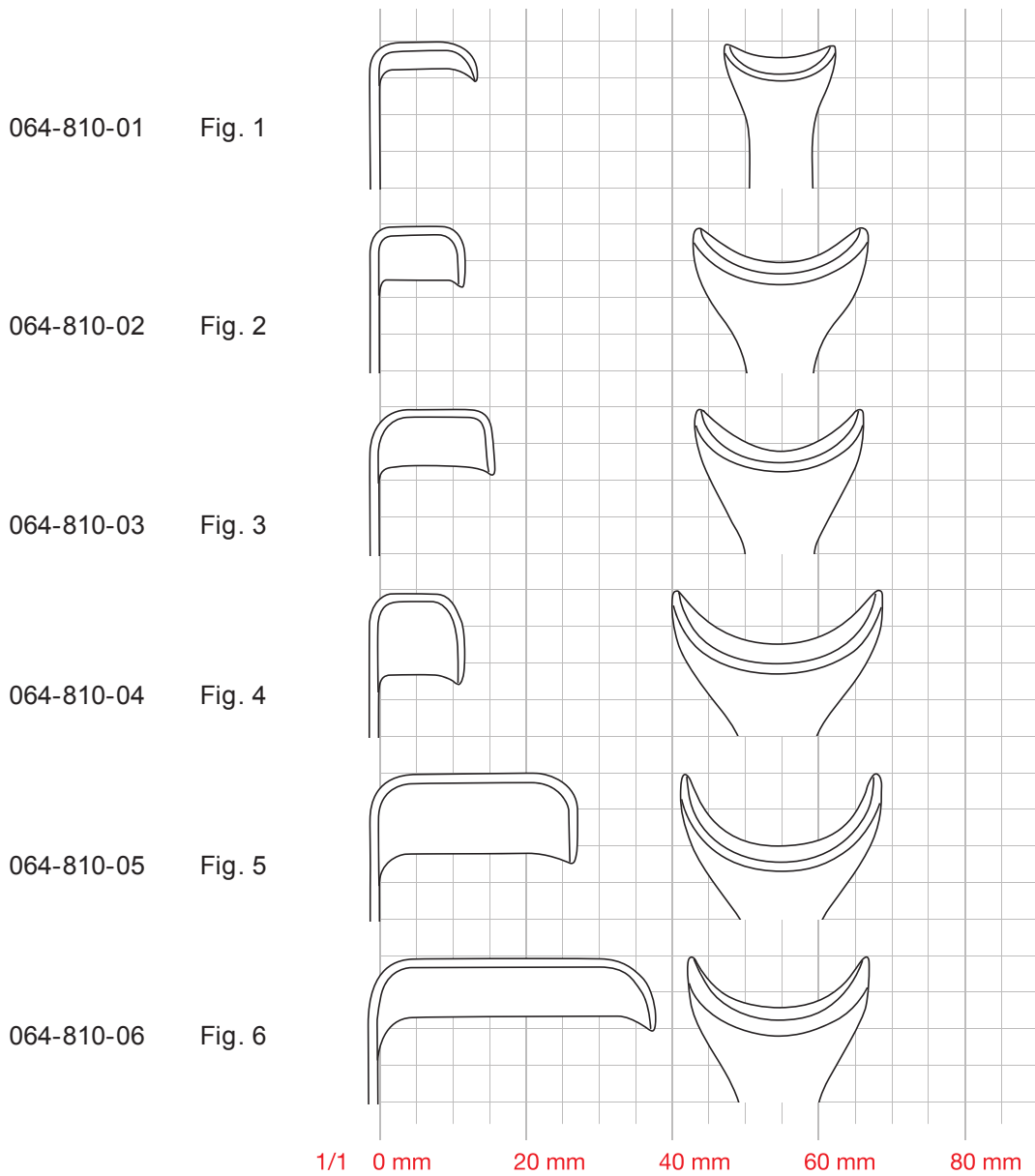

064

Weitere Artikel
further items
más artículos

Art.Nr.	Beschreibung Description	Size	Spez.
Other items available but not illustrated			
064-000-01	VOLKMANN Retractor; 1 teeth; sharp	24,5cm; 9,8"	
064-033-06	ISRAEL Retractor; 6 teeth; blunt; 70X70mm	25,0cm; 10"	
	LANGENBECK-STILLE Retractor	21,0cm; 8,4"	
064-121-07	20X7mm		
064-121-10	30X10mm		
064-121-15	30X15mm		
064-121-20	30X20mm		
064-121-45	45X20mm		
064-121-60	60X20mm		
064-130-22	KOCHER-LANGENBECK Retractor; 22X6mm	21,5cm; 8,6"	
	KOCHER-LANGENBECK	22,0cm; 8,8"	
064-146-25	25X7mm; curved down		
064-146-31	31X10mm; curved down		
064-146-42	42X11mm; curved down		
	OBWEGESER Retractor	22,0cm; 8,8"	
064-146-55	55X12mm; curved down		
064-147-25	25X7mm; curved up		
064-147-31	31X10mm; curved up		
064-147-42	42X11mm; curved up		
064-147-55	55X12mm; curved up		
	MIDDELDORPF Retractor	25,0cm; 10"	
064-192-01	40X45mm		
064-192-02	40X50mm		
064-192-03	55X70mm		
	KELLY Retractor	24,0cm; 9,6"	
064-212-01	40X50mm; Loop Handle		
064-212-02	50X65mm; Loop Handle		
064-212-03	65X70mm; Loop Handle		
064-212-04	75X90mm; Loop Handle		
	Caspar nerve root retractor	24,0cm; 9,6"	
064-215-04	4mm		
064-215-06	6mm		
064-215-08	8mm		
064-215-10	10mm		
	LOVE (MORSE) Retractor	25,0cm; 10"	
064-218-10	10mm width of blade		
064-218-15	15mm width of blade		
064-218-20	20mm width of blade		
064-218-30	30mm width of blade		
064-218-40	40mm width of blade		
064-218-50	50mm width of blade		

Weitere Artikel
further items
más artículos



Art.Nr.	Beschreibung Description	Size	Spez.
Other items available but not illustrated			
064-220-01	DOYEN-STILLE Retractor 120X52mm width of blade	22,0cm; 8,8"	
064-220-02	105X30mm width of blade		
064-220-03	90X28mm width of blade		
064-221-01	Retractor 110X35mm width of blade	22,0cm; 8,8"	
064-221-02	140X35mm width of blade		
064-221-03	110X55mm width of blade		
064-224-01	HOESEL Retractor 60X20mm width of blade	25,0cm; 10"	
064-224-02	80X30mm width of blade		
064-224-03	100X30mm width of blade		
064-224-04	120X30mm width of blade		
064-224-05	140X30mm width of blade		
064-224-06	140X40mm width of blade		
064-224-07	220X40mm width of blade		
064-234-23	TUFFIER Retractor; 64X60mm width of blade	23,0cm; 9,2"	
064-250-71	KOCHER Retractor; 70X25mm	22,0cm; 8,8"	
064-262-28	MODELL TÜBINGEN Retractor 95X20mm width of blade	28,0cm; 11,2"	
064-290-38	MORRIS Retractor 70X38mm width of blade	24,5cm; 9,8"	
064-290-51	70X50mm width of blade		
064-354-20	KADER Retractor 20mm width of blade	27,0cm; 10,8"	
064-354-30	30mm width of blade		
064-354-40	40mm width of blade		
064-360-08	BRUNNER Retractor 80X20mm; straight blade	25,0cm; 10"	
064-360-10	100X20mm; straight blade		
064-360-12	120X25mm; straight blade		
064-360-14	140X25mm; straight blade		
064-360-16	160X30mm; straight blade		
064-360-18	180X30mm; straight blade		
064-500-64	HARRINGTON Retractor; 175X64mm	32,0cm; 12,8"	
064-600-00	DEAVER Retractor 100mm	30,5cm; 12,2"	
064-600-26	25mm	33,0cm; 13,2"	
064-602-19	19mm	18,0cm; 7,2"	
064-602-25	25mm	23,0cm; 9,2"	
064-610-30	38mm	30,0cm; 12"	

064

Weitere Artikel
further items
más artículos

Art.Nr.	Beschreibung Description	Size	Spez.
Other items available but not illustrated			
064-620-28	KOERTE Retractor; 100X45mm	28,0cm; 11,2"	
064-622-33	KUEMMEL Retractor; 45mm; flexible	33,0cm; 13,2"	
	Retractor	41,0cm; 16,4"	
064-630-30	245X30mm; flexible		
064-630-40	245X40mm; flexible		
064-630-50	245X50mm; flexible		
064-630-60	245X60mm; flexible		
064-630-70	245X60mm; flexible		
	COOLEY-STRUCK Atrium Retractor	24,0cm; 9,6"	
064-800-01	45X30mm; toothed		
064-800-02	45X35mm; toothed		



Alphabetisches Verzeichnis

A	
ADSON, Nerv- und Gefäßhaken.....	062.12
ALLISON, Lungenspatel.....	064.32
Aortahaken, CRAWFORD.....	064.33
Aortahaken, ROSS.....	064.36
Atriumhaken, COOLEY.....	064.34
B	
BABY-ROUX, Wundhaken.....	062.20
BOSE, Trachealhaken.....	062.9
BROM, Venenhaken.....	062.3
BRUNNER, Wundhaken.....	064.25, 064.26
C	
COOLEY, Atriumhaken.....	064.34
CORYLLOS, Wundhaken.....	064.24
COTTLE, Hauthäkchen.....	062.5
CRAWFORD, Aortahaken.....	064.33
CRILE, Nerv- und Gefäßhaken.....	062.13
CUSHING, Nerv- und Gefäßhaken.....	062.12
CUSHING, Nervhaken.....	062.12
CUSHING, Wundhaken.....	062.17- 062.19
CZERNY, Wundhaken.....	062.21
D	
DANDY, Nerv- und Gefäßhaken.....	062.12, 062.13
DAVIDSON, Scapula-Haken.....	064.33
DEAVER GRIP, Wundhaken.....	064.31
DEAVER, Wundhaken.....	064.28- 064.30
DESMARRES, Wundhaken.....	062.17
DOYEN, Wundhaken.....	064.16
Durahaken, FISCH.....	062.2
Durahaken, GRAHAM.....	062.2
Durahaken, SACHS.....	062.2
F	
FARABEUF, Wundhaken.....	062.19
FISCH, Durahaken.....	062.2
FRAZIER, Hauthäkchen.....	062.4
FREER, Wundhaken.....	062.6
FRITSCH, Wundhaken.....	064.18
G	
GILLIES, Hauthäkchen.....	062.4
GIL-VERNET, Wundhaken.....	062.18
GOELET, Wundhaken.....	062.22
GRAEFE, Hauthäkchen.....	062.5, 062.6
GRAEFE, Schielhaken.....	062.3
GRAHAM, Durahaken.....	062.2
GRONINGEN, Nerv- und Gefäßhaken.....	062.13
GUTHRIE, Hauthäkchen.....	062.6
H	
HARRINGTON, Wundhaken.....	064.27
Hauthäkchen.....	062.5
Hauthäkchen, COTTLE.....	062.5
Hauthäkchen, FRAZIER.....	062.4
Hauthäkchen, GILLIES.....	062.4
Hauthäkchen, GRAEFE.....	062.5, 062.6
Hauthäkchen, GUTHRIE.....	062.6
Hauthäkchen, JOSEPH.....	062.5, 062.7
Hauthäkchen, KILNER.....	062.4
Hauthäkchen, KLEINERT-KUTZ.....	062.4
Hauthäkchen, O'CONNOR.....	062.5
I	
ISRAEL, Wundhaken.....	064.6
ITERSON, Trachealhaken.....	062.9
J	
JACKSON, Trachealhaken.....	062.8
JOSEPH, Hauthäkchen.....	062.5, 062.7
K	
KELLY, Wundhaken.....	064.22
KILNER, Hauthäkchen.....	062.4
KLEINERT-KUTZ, Hauthäkchen.....	062.4
KNAPP, Wundhaken.....	062.6
KOCHER, Wundhaken.....	064.3, 064.12- 064.17
KOCHER-LANGENBECK, Wundhaken.....	064.11
KOERTE, Wundhaken.....	064.5
KRÄHENBÜHL, Nerv- und Gefäßhaken.....	062.13
KÜMMEL, Wundhaken.....	064.32
L	
LAHEY, Wundhaken.....	064.8
LANGENBECK, Wundhaken.....	064.7- 064.10
LANGENBECK-GREEN, Wundhaken.....	062.14
LITTLE, Wundhaken.....	064.8
LUER, Trachealhaken.....	062.8
Lungenspatel, ALLISON.....	064.32
M	
MARTIN, Wundhaken.....	064.19
MATHIEU, Wundhaken.....	062.21
MEYERDING, Wundhaken.....	062.14, 064.23
MIDDELDORPF, Wundhaken.....	064.14
MIKULICZ, Wundhaken.....	064.20, 064.21
MINI-LANGENBECK, Wundhaken.....	062.15
MINI-ROUX, Wundhaken.....	062.20
MOLDESTAD, Venenhaken.....	062.2
N	
Nerv- und Gefäßhaken, ADSON.....	062.12
Nerv- und Gefäßhaken, CUSHING.....	062.12
Nerv- und Gefäßhaken, DANDY.....	062.12, 062.13
Nerv- und Gefäßhaken, GRONINGEN.....	062.13
Nerv- und Gefäßhaken, KRÄHENBÜHL.....	062.13
Nervhaken, CUSHING.....	062.12
NEWS, Trachealhaken.....	062.8

Alphabetisches Verzeichnis

O

O'CONNOR, Hauthäkchen062.5
OLLIER, Wundhaken064.6

P

PARKER, Wundhaken062.20
PARKER-LANGENBECK, Wundhaken062.21
Pelvishaken, ST. MARKS064.35

R

RAGNELL, Wundhaken062.16
RAGNELL-DAVIS, Wundhaken062.16
RICHARDSON (KELLY), Wundhaken064.15
RICHARDSON-EASTMAN, Wundhaken064.15
ROLLET, Wundhaken062.6
ROSE, Trachealhaken062.8
ROSS, Aortahaken064.36
ROUX, Wundhaken062.19

S

SACHS, Durahaken062.2
SAUERBRUCH, Wundhaken064.13, 064.20
Scapula-Haken, DAVIDSON064.33
Schielhaken, GRAEFE062.3
SENN-GREEN, Wundhaken062.14
SENN-MILLER, Wundhaken062.16
SIMON, Wundhaken064.19
ST. MARKS, Pelvishaken064.35

T

Trachealhaken062.7, 062.10, 062.11
Trachealhaken, BOSE062.9
Trachealhaken, ITERSON062.9
Trachealhaken, JACKSON062.8
Trachealhaken, LUER062.8
Trachealhaken, NEWS062.8
Trachealhaken, ROSE062.8

V

Venenhaken, BROM062.3
Venenhaken, MOLDESTAD062.2
VOLKMANN, Wundhaken064.2- 064.4

W

WASSMUND, Wundhaken064.5
Wundhaken, BABY-ROUX062.20
Wundhaken, BRUNNER064.25, 064.26
Wundhaken, CORYLLOS064.24
Wundhaken, CUSHING062.17- 062.19
Wundhaken, CZERNY062.21
Wundhaken, DEAVER064.28- 064.31
Wundhaken, DEAVER GRIP064.31
Wundhaken, DESMARRES062.17
Wundhaken, DOYEN064.16
Wundhaken, FARABEUF062.19
Wundhaken, FREER062.6

Wundhaken, FRITSCH064.18
Wundhaken, GIL-VERNET062.18
Wundhaken, GOELET062.22
Wundhaken, HARRINGTON064.27
Wundhaken, ISRAEL064.6
Wundhaken, KELLY064.22
Wundhaken, KNAPP062.6
Wundhaken, KOCHER064.3, 064.12- 064.17
Wundhaken, KOCHER-LANGENBECK064.11
Wundhaken, KOERTE064.5
Wundhaken, KÜMMEL064.32
Wundhaken, LAHEY064.8
Wundhaken, LANGENBECK064.7- 064.10
Wundhaken, LANGENBECK-GREEN062.14
Wundhaken, LITTLE064.8
Wundhaken, MARTIN064.19
Wundhaken, MATHIEU062.21
Wundhaken, MEYERDING062.14, 064.23
Wundhaken, MIDDELDORPF064.14
Wundhaken, MIKULICZ064.20, 064.21
Wundhaken, MINI-LANGENBECK062.15
Wundhaken, MINI-ROUX062.20
Wundhaken, OLLIER064.6
Wundhaken, PARKER062.20
Wundhaken, PARKER-LANGENBECK062.21
Wundhaken, RAGNELL062.16
Wundhaken, RAGNELL-DAVIS062.16
Wundhaken, RICHARDSON (KELLY)064.15
Wundhaken, RICHARDSON-EASTMAN064.15
Wundhaken, ROLLET062.6
Wundhaken, ROUX062.19
Wundhaken, SAUERBRUCH064.13, 064.20
Wundhaken, SENN-GREEN062.14
Wundhaken, SENN-MILLER062.16
Wundhaken, SIMON064.19
Wundhaken, VOLKMANN064.2, 064.4
Wundhaken, WASSMUND064.5
Wundhaken, ZENKER064.23

Z

ZENKER, Wundhaken064.23



Index, alphabetical

- A**
- ADSON, nerv and vessel hooklet062.12
- ALLISON, lung spatula064.32
- aorta retractor, CRAWFORD.....064.33
- aorta retractor, ROSS064.36
- atrium retractor, COOLEY064.34
- B**
- BABY-ROUX, retractor062.20
- BOSE, tracheal hook062.9
- BROM, vein hook062.3
- BRUNNER, retractor.....064.25, 064.26
- C**
- COOLEY, atrium retractor.....064.34
- CORYLLOS, retractor.....064.24
- COTTLE, skin hooklet.....062.5
- CRAWFORD, aorta retractor064.33
- CRILE, nerv and vessel hooklet062.13
- CUSHING, nerv and vessel hooklet062.12
- CUSHING, nerv hook062.12
- CUSHING, retractor.....062.17- 062.19
- CZERNY, retractor062.21
- D**
- DANDY, nerv and vessel hooklet.....062.12, 062.13
- DAVIDSON, scapula retractor064.33
- DEAVER GRIP, retractor064.31
- DEAVER, retractor064.28- 064.31
- DESMARRES, retractor.....062.17
- DOYEN, retractor064.16
- dura hook, FISCH.....062.2
- dura hook, GRAHAM.....062.2
- dura hook, SACHS062.2
- F**
- FARABEUF, retractor062.19
- FISCH, dura hook.....062.2
- FRAZIER, skin hooklet.....062.4
- FREER, retractor062.6
- FRITSCH, retractor.....064.18
- G**
- GILLIES, skin hooklet062.4
- GIL-VERNET, retractor.....062.18
- GOELET, retractor062.22
- GRAEFE, skin hooklet062.5, 062.6
- GRAEFE, strabismus hook.....062.3
- GRAHAM, dura hook.....062.2
- GRONINGEN, nerv and vessel hooklet062.13
- GUTHRIE, skin hooklet.....062.6
- H**
- HARRINGTON, retractor064.27
- I**
- ISRAEL, retractor.....064.6
- ITERSON, tracheal hook062.9
- J**
- JACKSON, tracheal hook.....062.8
- JOSEPH, skin hooklet062.5, 062.7
- K**
- KELLY, retractor.....064.22
- KILNER, skin hooklet.....062.4
- KLEINERT-KUTZ, skin hooklet062.4
- KNAPP, retractor.....062.6
- KOCHER, retractor.....064.3, 064.12- 064.17
- KOCHER-LANGENBECK, retractor064.11
- KOERTE, retractor.....064.5
- KRÄHENBÜHL, nerv and vessel hooklet062.13
- KÜMMEL, retractor064.32
- L**
- LAHEY, retractor.....064.8
- LANGENBECK, retractor.....064.7- 064.10
- LANGENBECK-GREEN, retractor062.14
- LITTLE, retractor.....064.8
- LUER, tracheal hook062.8
- lung spatula, ALLISON064.32
- M**
- MARTIN, retractor064.19
- MATHIEU, retractor062.21
- MEYERDING, retractor.....062.14, 064.23
- MIDDELDORPF, retractor.....064.14
- MIKULICZ, retractor064.20, 064.21
- MINI-LANGENBECK, retractor.....062.15
- MINI-ROUX, retractor.....062.20
- MOLDESTAD, vein hook062.2
- N**
- nerv and vessel hooklet, ADSON062.12
- nerv and vessel hooklet, CUSHING062.12
- nerv and vessel hooklet, DANDY062.12, 02.13
- nerv and vessel hooklet, GRONINGEN062.13
- nerv and vessel hooklet, KRÄHENBÜHL062.13
- nerv hook, CUSHING062.12
- NEWS, tracheal hook062.8
- O**
- O'CONNOR, skin hooklet.....062.5
- OLLIER, retractor.....064.6
- P**
- PARKER, retractor.....062.20
- PARKER-LANGENBECK, retractor062.21
- pelvis retractor, ST. MARKS064.35
- R**
- RAGNELL, retractor.....062.16

Index, alphabetical

RAGNELL-DAVIS, retractor.....	062.16
retractor, BABY-ROUX.....	062.20
retractor, BRUNNER.....	064.25, 064.26
retractor, CORYLLOS.....	064.24
retractor, CUSHING.....	062.17- 062.19
retractor, CZERNY.....	062.21
retractor, DEAVER.....	064.28- 064.31
retractor, DEAVER GRIP.....	064.31
retractor, DESMARRÉS.....	062.17
retractor, DOYEN.....	064.16
retractor, FARABEUF.....	062.19
retractor, FREER.....	062.6
retractor, FRITSCH.....	064.18
retractor, GIL-VERNET.....	062.18
retractor, GOELET.....	062.22
retractor, HARRINGTON.....	064.27
retractor, ISRAEL.....	064.6
retractor, KELLY.....	064.22
retractor, KNAPP.....	062.6
retractor, KOCHER.....	064.3, 064.12- 064.17
retractor, KOCHER-LANGENBECK.....	064.11
retractor, KOERTE.....	064.5
retractor, KÜMMEL.....	064.32
retractor, LAHEY.....	064.8
retractor, LANGENBECK.....	064.7- 064.10
retractor, LANGENBECK-GREEN.....	062.14
retractor, LITTLE.....	064.8
retractor, MARTIN.....	064.19
retractor, MATHIEU.....	062.21
retractor, MEYERDING.....	062.14, 064.23
retractor, MIDDELDORPF.....	064.14
retractor, MIKULICZ.....	064.20, 064.21
retractor, MINI-LANGENBECK.....	062.15
retractor, MINI-ROUX.....	062.20
retractor, OLLIER.....	064.6
retractor, PARKER.....	062.20
retractor, PARKER-LANGENBECK.....	062.21
retractor, RAGNELL.....	062.16
retractor, RAGNELL-DAVIS.....	062.16
retractor, RICHARDSON (KELLY).....	064.15
retractor, RICHARDSON-EASTMAN.....	064.15
retractor, ROLLET.....	062.6
retractor, ROUX.....	062.19
retractor, SAUERBRUCH.....	064.13, 064.20
retractor, SENN-GREEN.....	062.14
retractor, SENN-MILLER.....	062.16
retractor, SIMON.....	064.19
retractor, VOLKMANN.....	064.2, 064.4
retractor, WASSMUND.....	064.5
retractor, ZENKER.....	064.23
RICHARDSON (KELLY), retractor.....	064.15
RICHARDSON-EASTMAN, retractor.....	064.15
ROLLET, retractor.....	062.6
ROSE, tracheal hook.....	062.8
ROSS, aorta retractor.....	064.36
ROUX, retractor.....	062.19

S

SACHS, dura hook.....	062.2
SAUERBRUCH, retractor.....	064.13, 064.20
scapula retractor, DAVIDSON.....	064.33
SENN-GREEN, retractor.....	062.14
SENN-MILLER, retractor.....	062.16
SIMON, retractor.....	064.19
skin hooklet.....	062.5
skin hooklet, COTTLE.....	062.5
skin hooklet, FRAZIER.....	062.4
skin hooklet, GILLIES.....	062.4
skin hooklet, GRAEFE.....	062.5
skin hooklet, GUTHRIE.....	062.6
skin hooklet, JOSEPH.....	062.7
skin hooklet, KILNER.....	062.4
skin hooklet, KLEINERT-KUTZ.....	062.4
skin hooklet, O'CONNOR.....	062.5
ST. MARKS, pelvis retractor.....	064.35
strabismus hook, GRAEFE.....	062.3

T

tracheal hook.....	062.7, 062.10, 062.11
tracheal hook, BOSE.....	062.9
tracheal hook, ITERSON.....	062.9
tracheal hook, JACKSON.....	062.8
tracheal hook, LUER.....	062.8
tracheal hook, NEWS.....	062.8
tracheal hook, ROSE.....	062.8

V

vein hook, BROM.....	062.3
vein hook, MOLDESTAD.....	062.2
VOLKMANN, retractor.....	064.2- 064.4

W

WASSMUND, retractor.....	064.5
--------------------------	-------

Z

ZENKER, retractor.....	064.23
------------------------	--------



Indice, alfabético

A

ADSON, ganchito para nervios y vasos062.12
ALLISON, espátula para el pulmón064.32

B

BABY-ROUX, separador062.20
BOSE, gancho traqueales062.9
BROM, vein hooks062.3
BRUNNER, separador064.25, 064.26

C

COOLEY, separador para atrio064.34
CORYLLOS, separador064.24
COTTLE, ganchito de piel062.5
CRAWFORD, separador para aorta064.33
CRILE, ganchito para nervios y vasos062.13
CUSHING, ganchito para nervios y vasos062.12
CUSHING, gancho para nervios062.12
CUSHING, separador062.17- 062.19
CZERNY, separador062.21

D

DANDY, ganchito para nervios y vasos062.12, 062.13
DAVIDSON, separador para scápula064.33
DEAVER GRIP, separador064.31
DEAVER, separador064.28- 064.31
DESMARRES, separador062.17
divaricatore per aorta, ROSS064.36
DOYEN, separador064.16

E

espátula para el pulmón, ALLISON064.32

F

FARABEUF, separador062.19
FISCH, gancho para duramadre062.2
FRAZIER, ganchito de piel062.4
FREER, retractor062.6
FRITSCH, separador064.18

G

ganchito de piel062.5
ganchito de piel, COTTLE062.5
ganchito de piel, FRAZIER062.4
ganchito de piel, GILLIES062.4
ganchito de piel, GRAEFE062.6
ganchito de piel, GUTHRIE062.6
ganchito de piel, JOSEPH062.5
ganchito de piel, KILNER062.4
ganchito de piel, KLEINERT-KUTZ062.4
ganchito de piel, O'CONNOR062.5
ganchito de piel, GUTHRIE062.6
ganchito de piel, JOSEPH062.7
ganchito para nervios y vasos, ADSON062.12
ganchito para nervios y vasos, CUSHING062.12
ganchito para nervios y vasos, DANDY062.12

ganchito para nervios y vasos, DANDY062.12
ganchito para nervios y vasos, DANDY062.13
ganchito para nervios y vasos, GRONINGEN062.13
ganchito para nervios y vasos, KRÄHENBÜHL062.13
gancho para duramadre, FISCH062.2
gancho para duramadre, GRAHAM062.2
gancho para duramadre, SACHS062.2
gancho para estrabismo, GRAEFE062.3
gancho para nervios, CUSHING062.12
gancho traqueales062.7
gancho traqueales062.10
gancho traqueales062.11
gancho traqueales, BOSE062.9
gancho traqueales, ITERSÓN062.9
gancho traqueales, JACKSON062.8
gancho traqueales, LUER062.8
gancho traqueales, NEWS062.8
gancho traqueales, ROSE062.8
GILLIES, ganchito de piel062.4
GILLIES, ganchito de piel062.4
GIL-VERNET, separador062.18
GOELET, separador062.22
GRAEFE, ganchito de piel062.5, 062.6
GRAEFE, gancho para estrabismo062.3
GRAHAM, gancho para duramadre062.2
GRONINGEN, ganchito para nervios y vasos062.13
GUTHRIE, ganchito de piel062.6

H

HARRINGTON, separador064.27

I

ISRAEL, separador064.6
ITERSÓN, gancho traqueales062.9

J

JACKSON, gancho traqueales062.8
JOSEPH, ganchito de piel062.5, 062.7

K

KELLY, separador064.22
KILNER, ganchito de piel062.4
KLEINERT-KUTZ, ganchito de piel062.4
KNAPP, retractor062.6
KOCHER, separador064.3, 064.12- 064.17
KOCHER-LANGENBECK, separador064.11
KOERTE, separador064.5
KRÄHENBÜHL, ganchito para nervios y vasos062.13
KÜMMEL, separador064.32

L

LAHEY, separador064.8
LANGENBECK, separador064.7- 064.10
LANGENBECK-GREEN, separador062.14
LITTLE, separador064.8
LUER, gancho traqueales062.8

Indice, alfabético

M

MARTIN, separador.....	064.19
MATHIEU, separador.....	062.21
MEYERDING, separador.....	062.14, 064.23
MIDDELDORPF, separador.....	064.14
MIKULICZ, separador.....	064.20, 064.21
MINI-LANGENBECK, separador.....	062.15
MINI-ROUX, separador.....	062.20
MOLDESTAD, vein hooks.....	062.2

N

NEWS, gancho traqueales.....	062.8
------------------------------	-------

O

O'CONNOR, gancho de piel.....	062.5
OLLIER, separador.....	064.6

P

PARKER, separador.....	062.20
PARKER-LANGENBECK, separador.....	062.21

R

RAGNELL, separador.....	062.16
RAGNELL-DAVIS, separador.....	062.16
retractor, FREER.....	062.6
retractor, KNAPP.....	062.6
retractor, ROLLET.....	062.6
RICHARDSON (KELLY), separador.....	064.15
RICHARDSON-EASTMAN, separador.....	064.15
ROLLET, retractor.....	062.6
ROSE, gancho traqueales.....	062.8
ROSS, divaricatore per aorta.....	064.36
ROUX, separador.....	062.19

S

SACHS, gancho para duramadre.....	062.2
SAUERBRUCH, separador.....	064.13, 064.20
SENN-GREEN, separador.....	062.14
SENN-MILLER, separador.....	062.16
separador.....	062.16
separador para atrio, COOLEY.....	064.34
separador para pelvis, ST. MARKS.....	064.35
separador para scápula, DAVIDSON.....	064.33
separador, BABY-ROUX.....	062.20
separador, BRUNNER.....	064.25, 064.26
separador, CORYLLOS.....	064.24
separador, CUSHING.....	062.17- 062.19
separador, CZERNY.....	062.21
separador, DEEVER.....	064.28- 064.31
separador, DEEVER GRIP.....	064.31
separador, DESMARRES.....	062.17
separador, DOYEN.....	064.16
separador, FARABEUF.....	062.19
separador, FRITSCH.....	064.18
separador, GIL-VERNET.....	062.18
separador, GOELET.....	062.22

separador, HARRINGTON.....	064.27
separador, ISRAEL.....	064.6
separador, KELLY.....	064.22
separador, KOCHER.....	064.3, 064.12- 064.17
separador, KOCHER-LANGENBECK.....	064.11
separador, KOERTE.....	064.5
separador, KÜMMEL.....	064.32
separador, LAHEY.....	064.8
separador, LANGENBECK.....	064.7- 064.10
separador, LANGENBECK-GREEN.....	062.14
separador, LITTLE.....	064.8
separador, MARTIN.....	064.19
separador, MATHIEU.....	062.21
separador, MEYERDING.....	062.14, 064.23
separador, MIDDELDORPF.....	064.14
separador, MIKULICZ.....	064.20, 064.21
separador, MINI-LANGENBECK.....	062.15
separador, MINI-ROUX.....	062.20
separador, OLLIER.....	064.6
separador, PARKER.....	062.20
separador, PARKER-LANGENBECK.....	062.21
separador, RAGNELL.....	062.16
separador, RAGNELL-DAVIS.....	062.16
separador, RICHARDSON (KELLY).....	064.15
separador, RICHARDSON-EASTMAN.....	064.15
separador, ROUX.....	062.19
separador, SAUERBRUCH.....	064.13, 064.20
separador, SENN-GREEN.....	062.14
separador, SENN-MILLER.....	062.16
separador, SIMON.....	064.19
separador, VOLKMANN.....	064.2- 064.4
separador, WASSMUND.....	064.5
separador, ZENKER.....	064.23
separador para áorta, CRAWFORD.....	064.33
SIMON, separador.....	064.19
ST. MARKS, separador para pelvis.....	064.35

V

vein hooks, BROM.....	062.3
vein hooks, MOLDESTAD.....	062.2
VOLKMANN, separador.....	064.2- 064.4

W

WASSMUND, separador.....	064.5
--------------------------	-------

Z

ZENKER, separador.....	064.23
------------------------	--------