

self-retaining Retractors

abdominal spatulas

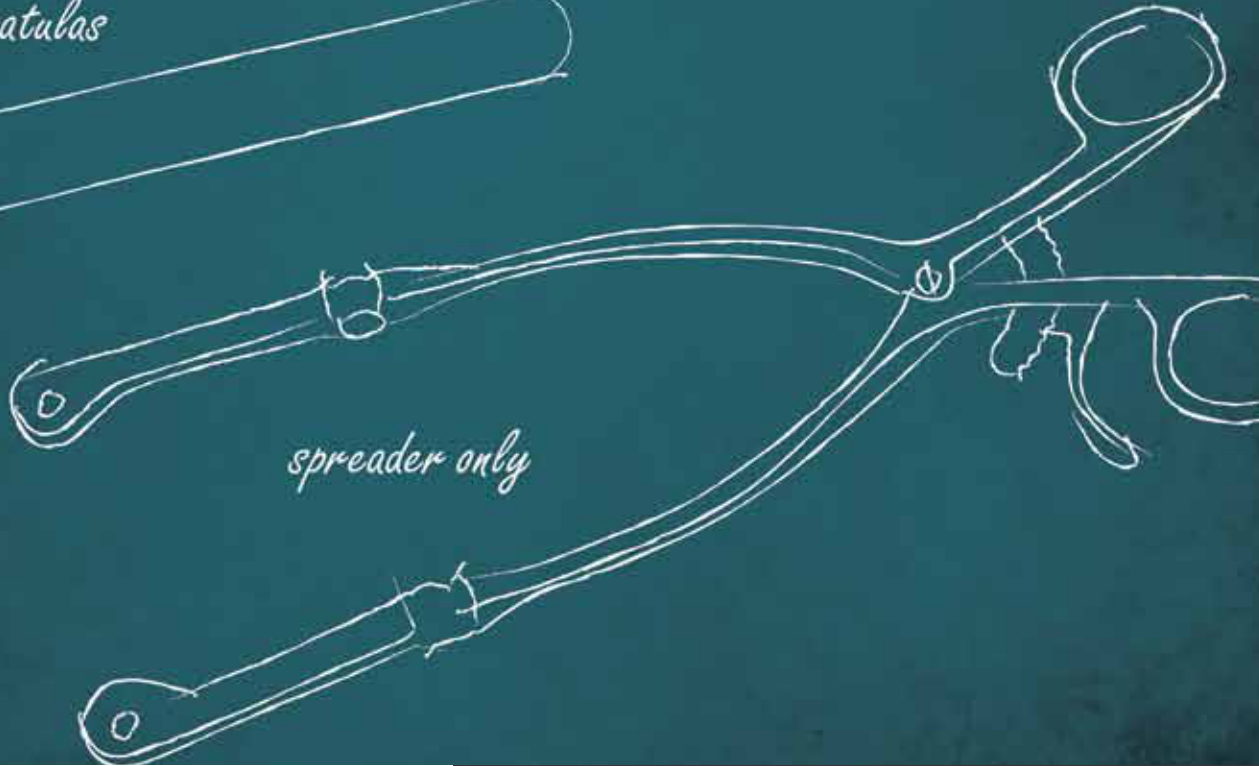

spreader only

Wundspreizer
Self-retaining Retractors

070

Wundspreizer
self-retaining Retractors
Separadores autoestáticos



Art.Nr. Beschreibung | Description Size Spez.

FINSEN



070-610-05

scharf | sharp
agudo

2 x 3

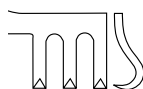

5,0cm; 2"

070-611-05

stumpf | blunt
romo

2 x 3

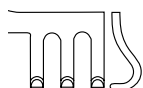

5,0cm; 2"

070-610-07

scharf | sharp
agudo

3 x 4

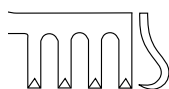

7,0cm; 2 6/8"

070-611-07

stumpf | blunt
romo

3 x 4

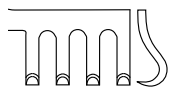

7,0cm; 2 6/8"

JANSEN

10,0cm; 3 7/8"



070-630-10

scharf | sharp
agudo

3 x 3

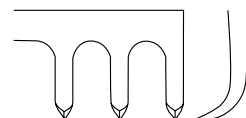

070-631-10

stumpf | blunt
romo

3 x 3

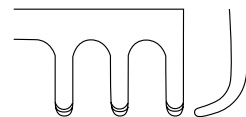

070

Wundspreizer
self-retaining Retractors
Separadores autoestáticos

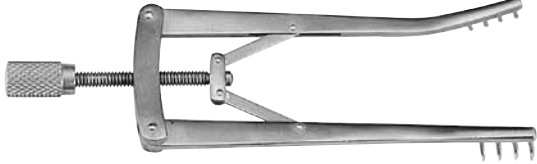
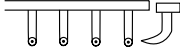
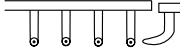
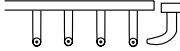
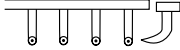
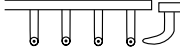
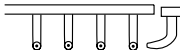
Art.Nr.	Beschreibung Description		Size	Spez.
	ALM			
070-620-07	scharf sharp agudo	4 x 4		7,0cm; 2 6/8"
070-622-07	halbscharf semi-sharp semi-agudo	4 x 4		7,0cm; 2 6/8"
070-621-07	stumpf blunt romo	4 x 4		7,0cm; 2 6/8"
070-620-10	scharf sharp agudo	4 x 4		10,0cm; 3 7/8"
070-622-10	halbscharf semi-sharp semi-agudo	4 x 4		10,0cm; 3 7/8"
070-621-10	stumpf blunt romo	4 x 4		10,0cm; 3 7/8"

Wundspreizer
self-retaining Retractors
Separadores autoestáticos



Art.Nr.	Beschreibung Description	Size	Spez.
---------	----------------------------	------	-------

WEITLANER-LOKTITE

10,5cm; 4 1/8"

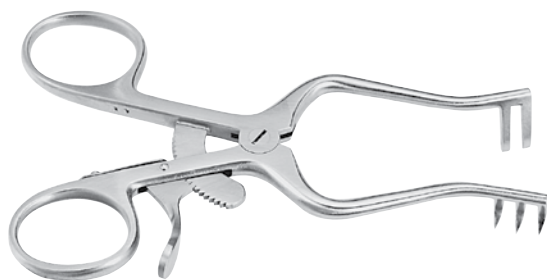

070-670-10 scharf | sharp
agudo 2 x 3

070-671-10 stumpf | blunt
romo 2 x 3

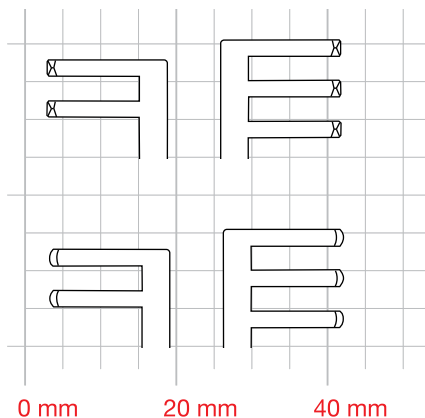

1/1 0 mm 20 mm 40 mm

SCALP-CONTOUR

14,0cm; 5 4/8"

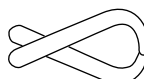

070-660-14 scharf | sharp
agudo 3 x 4

070-661-14 stumpf | blunt
romo 3 x 4

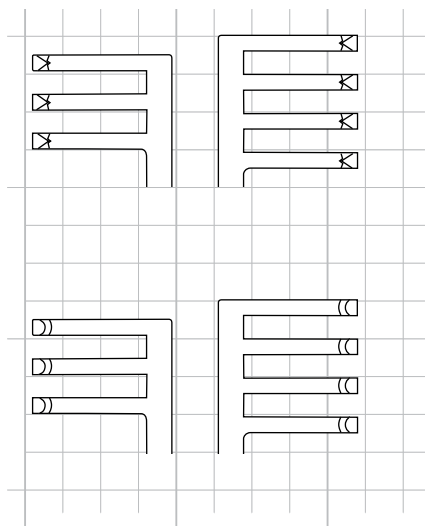

1/1 0 mm 20 mm 40 mm

070

Wundspreizer
self-retaining Retractors
Separadores autoestáticos

Art.Nr.	Beschreibung Description	Size	Spez.
070-674-15	MOLLISON scharf sharp agudo	15,5cm; 6 1/8"	

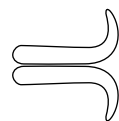

4 x 4

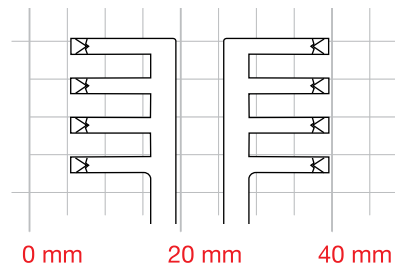

WEITLANER

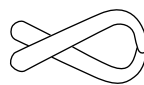

070-670-13	scharf sharp agudo	3 x 4		13,0cm; 5 1/8"
070-671-13	stumpf blunt romo	3 x 4		13,0cm; 5 1/8"
070-670-16	scharf sharp agudo	3 x 4		16,5cm; 6 4/8"
070-671-16	stumpf blunt romo	3 x 4		16,5cm; 6 4/8"

1/1 0 mm 20 mm 40 mm

Wundspreizer
self-retaining Retractors
Separadores autoestáticos



Art.Nr. Beschreibung | Description Size Spez.

WEITLANER

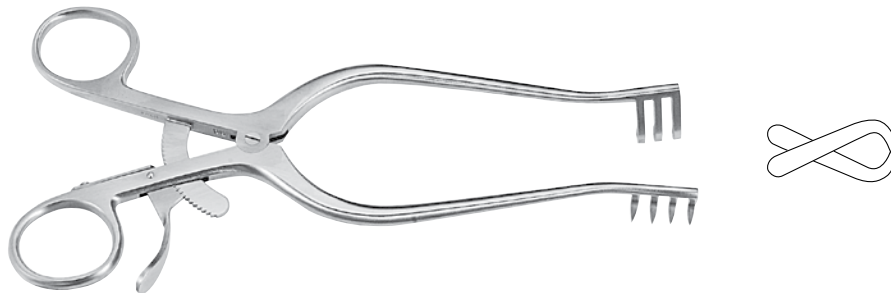

070-670-20

scharf | sharp
agudo

3 x 4

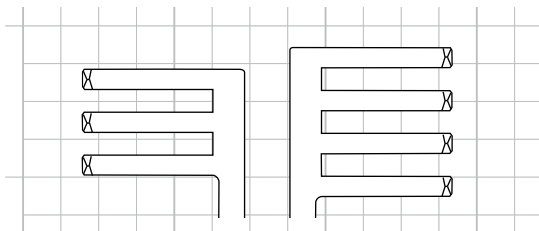

20,0cm; 7 7/8"

070-671-20

stumpf | blunt
romo

3 x 4

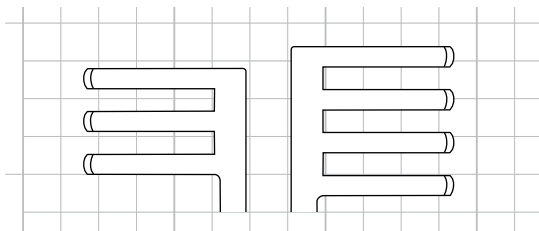

20,0cm; 7 7/8"

070-670-24

scharf | sharp
agudo

3 x 4

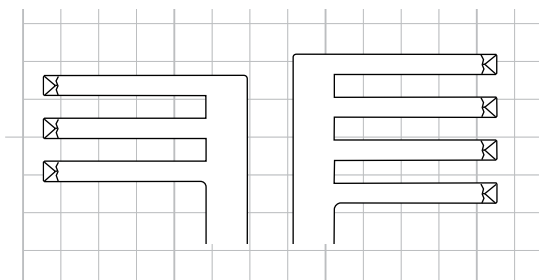

24,0cm; 9 4/8"

070-671-24

stumpf | blunt
romo

3 x 4

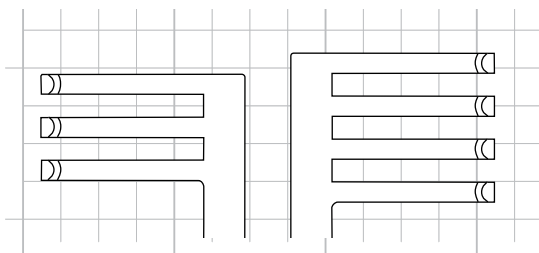

24,0cm; 9 4/8"

1/1 0 mm 20 mm 40 mm 60 mm

070

Wundspreizer
 self-retaining Retractors
 Separadores autoestáticos

Art.Nr.	Beschreibung Description	Size	Spez.
	WULLSTEIN		13,0cm; 5 1/8"

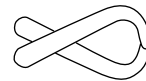

070-810-13

scharf | sharp
 romo

3 x 3

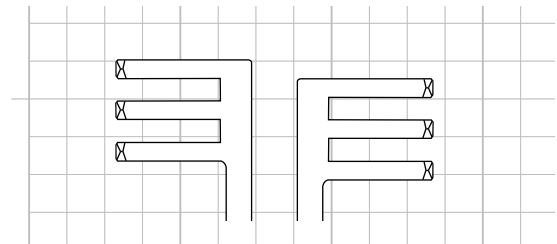

070-811-13

stumpf | blunt
 agudo

3 x 3

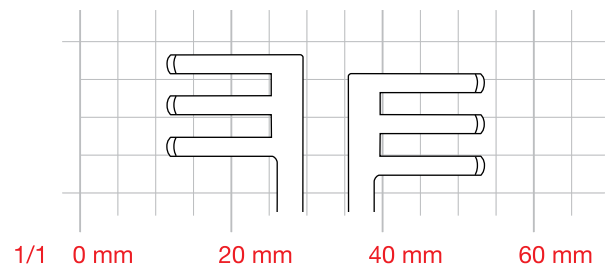

Wundspreizer
self-retaining Retractors
Separadores autoestáticos



Art.Nr.	Beschreibung Description	Size	Spez.
---------	----------------------------	------	-------

070-840-13	MILLIGAN stumpf blunt romo	13,0cm; 5 1/8"	
------------	---------------------------------	----------------	--

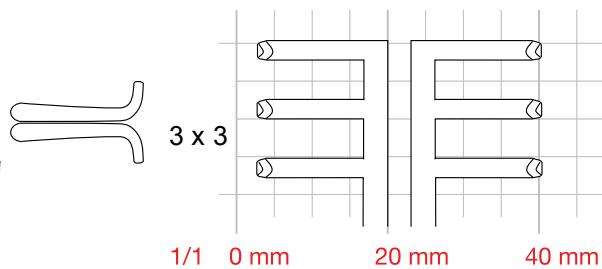

ANDERSON-ADSON

20,0cm; 7 7/8"

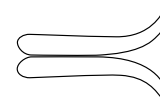

070-678-20	scharf sharp agudo	4 x 4	
------------	-------------------------	-------	--

4 x 4

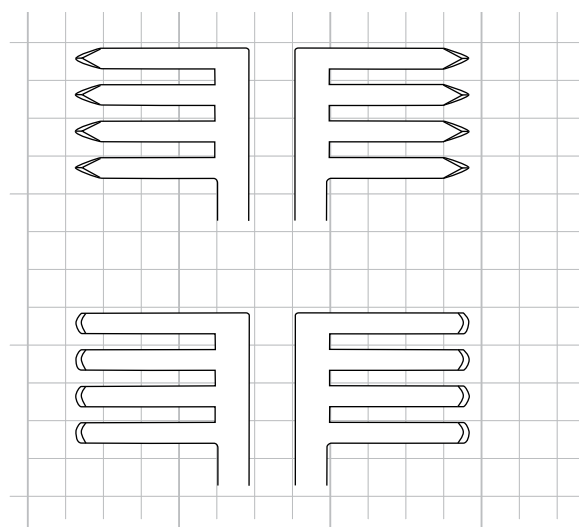

070-679-20	stumpf blunt romo	4 x 4	
------------	------------------------	-------	--

4 x 4

1/1 0 mm 20 mm 40 mm 60 mm

070

Wundspreizer
 self-retaining Retractors
 Separadores autoestáticos

Art.Nr.	Beschreibung Description	Size	Spez.
	ADSON	26,0cm; 10 2/8"	

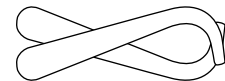

070-682-26 scharf | sharp
 agudo

3 x 4

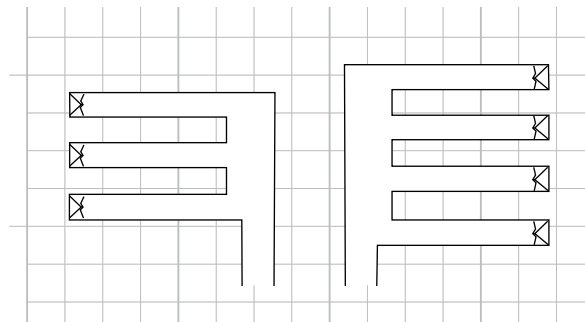

070-683-26 stumpf | blunt
 romo

3 x 4

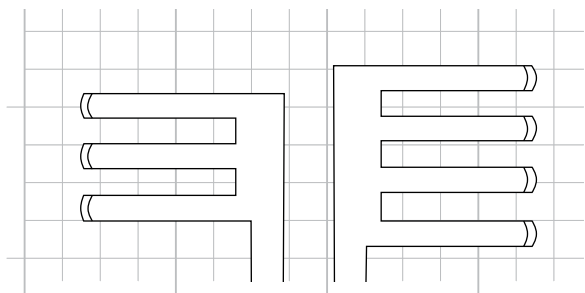

1/1 0 mm 20 mm 40 mm 60 mm

Wundspreizer
self-retaining Retractors
Separadores autoestáticos



Art.Nr.	Beschreibung Description	Size	Spez.
	ADSON	29,0cm; 11 3/8"	

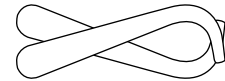

070-682-29

scharf | sharp
agudo

6 x 6

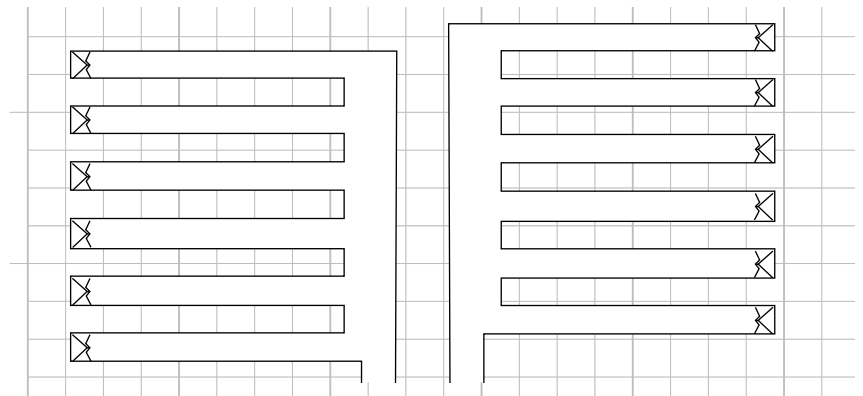

070-683-29

stumpf | blunt
romo

6 x 6

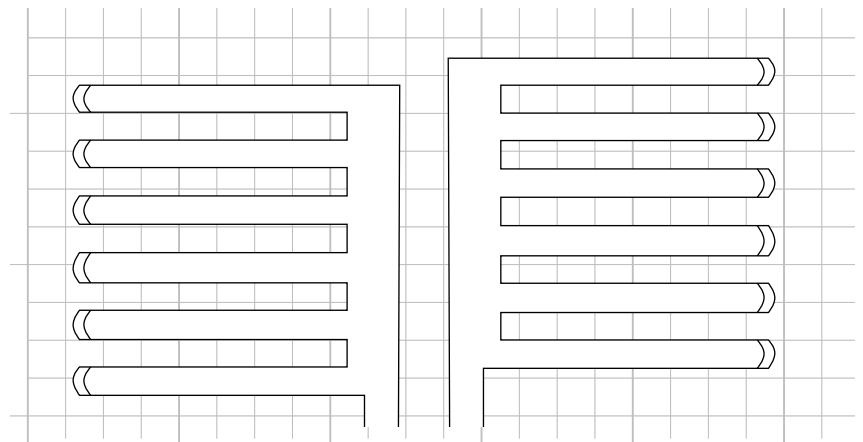

1/1 0 mm 20 mm 40 mm 60 mm 80 mm 100 mm

070

Wundspreizer
self-retaining Retractors
Separadores autoestáticos

Art.Nr. Beschreibung | Description Size Spez.

PLESTER

13,0cm; 5 1/8"



070-830-13

scharf | sharp
agudo

2 x 2

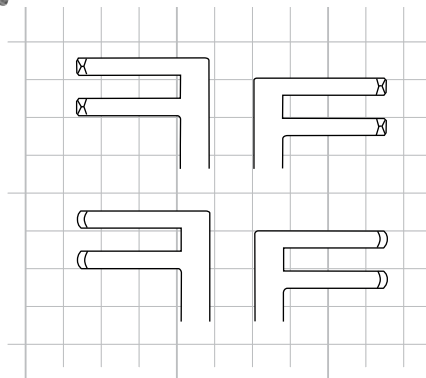

070-831-13

stumpf | blunt
romo

2 x 2

1/1 0 mm 20 mm 40 mm

PLESTER scharf | sharp
agudo

11,0cm; 4 3/8"



070-672-11

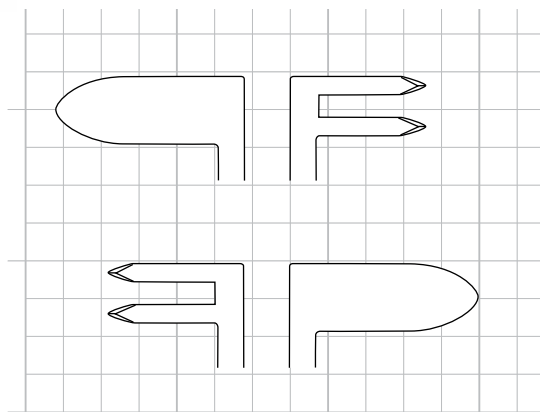
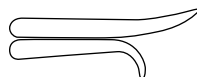

070-673-11

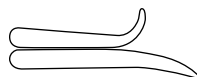

1/1 0 mm 20 mm 40 mm 60 mm

Wundspreizer
self-retaining Retractors
Separadores autoestáticos



Art.Nr.	Beschreibung Description	Size	Spez.
070-850-13	WEITLANER-BABY	13,5cm; 5 3/8"	

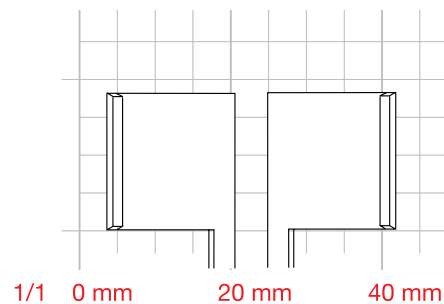

070-320-17	MAYO-ADAMS mit Mittelvalve with central blade con valva central	17,0cm; 6 6/8"	
------------	--	----------------	--

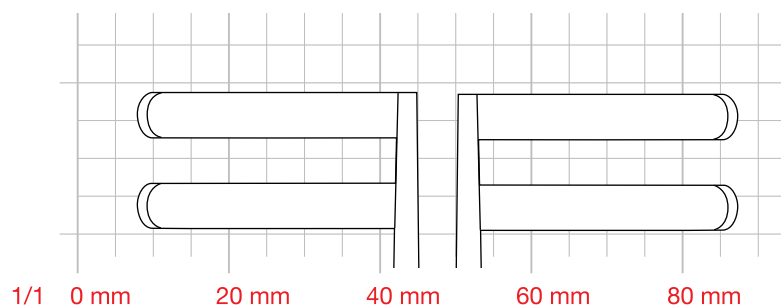
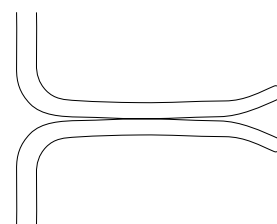
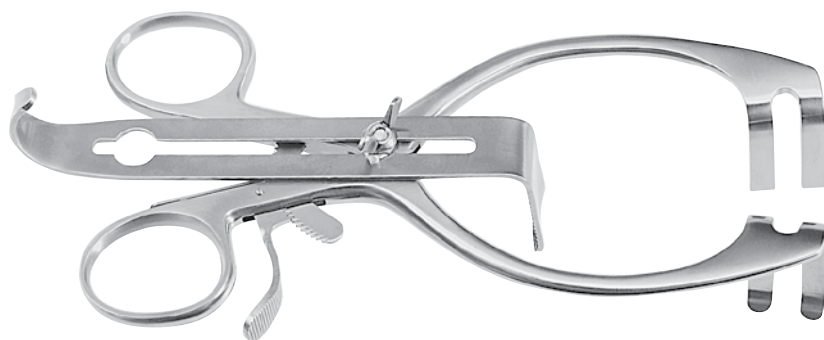

070

Wundspreizer
self-retaining Retractors
Separadores autoestáticos

Art.Nr.	Beschreibung Description	Size	Spez.
---------	----------------------------	------	-------

MEYERDING

20,0cm; 7 7/8"

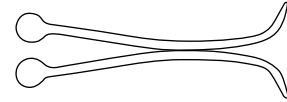
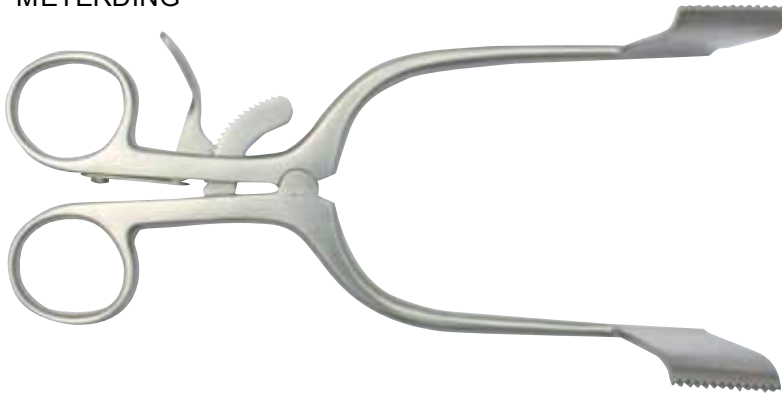

070-482-04

65 x 25 mm

65 x 25 mm

070-482-02

55 x 25 mm

55 x 25 mm

070-482-01

32 x 25 mm

32 x 25 mm

1/1 0 mm 20 mm 40 mm 60 mm 80 mm 100 mm 120 mm 140 mm

Wundspreizer
self-retaining Retractors
Separadores autoestáticos



Art.Nr. Beschreibung | Description Size Spez.

ADSON

3 x 4



070-860-13

scharf | sharp
agudo

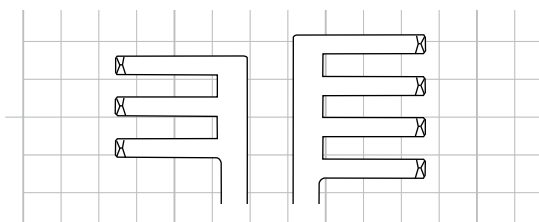

13,5cm; 5 3/8"

070-860-16

scharf | sharp
agudo

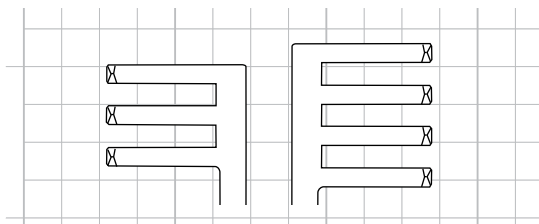

16,0cm; 6 2/8"

070-861-13

stumpf | blunt
romo

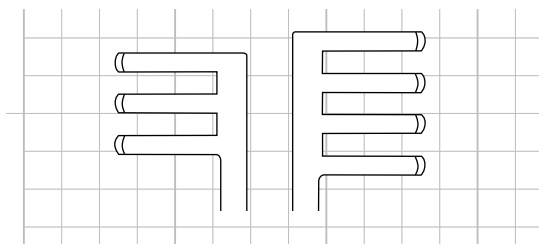

13,5cm; 5 3/8"

070-861-16

stumpf | blunt
romo

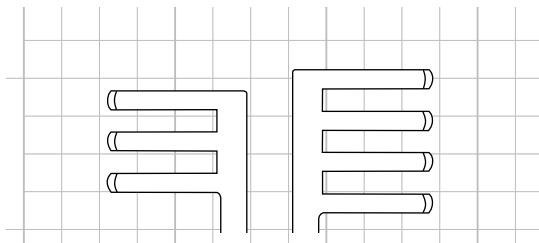

16,0cm; 6 2/8"

1/1 0 mm 20 mm 40 mm 60 mm

070

Wundspreizer
self-retaining Retractors
Separadores autoestáticos

Art.Nr. Beschreibung | Description Size Spez.

ADSON

3 x 4

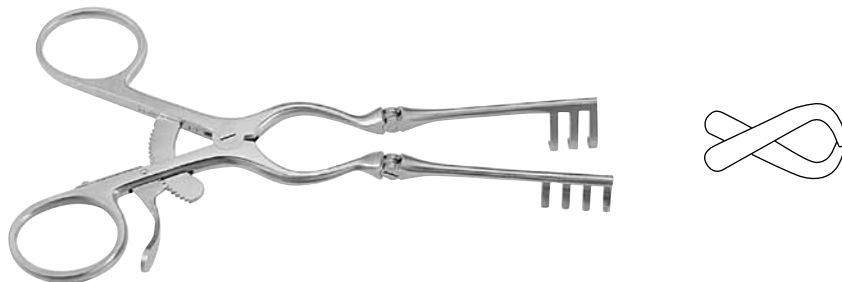

070-860-20

scharf | sharp
agudo

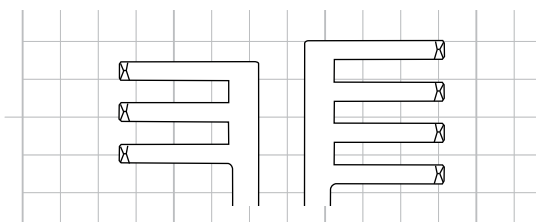

20,0cm, 7 7/8"

070-860-26

scharf | sharp
agudo

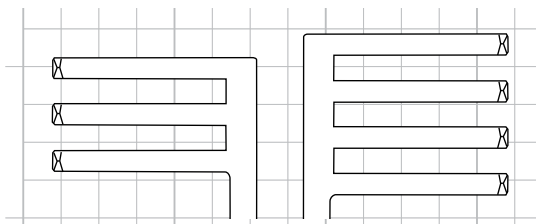

26,0cm; 10 2/8"

070-861-20

stumpf | blunt
romo

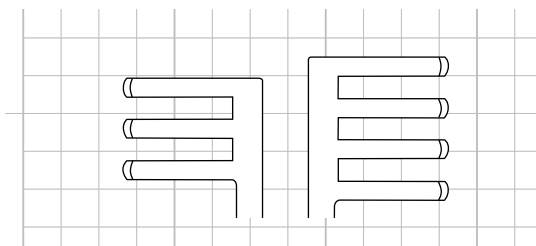

20,0cm; 7 7/8"

070-861-26

stumpf | blunt
romo

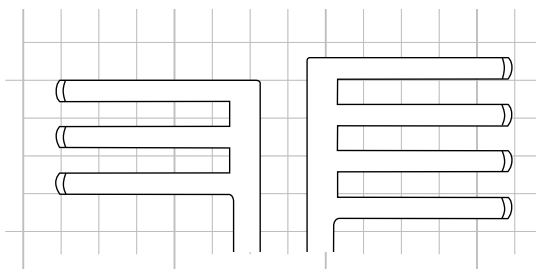

26,0cm; 10 2/8"

1/1 0 mm 20 mm 40 mm 60 mm

070

Wundspreizer
self-retaining Retractors
Separadores autoestáticos



Art.Nr.	Beschreibung Description	Size	Spez.
	ADSON scharf sharp agudo	28,5cm; 11 2/8"	



070-561-01

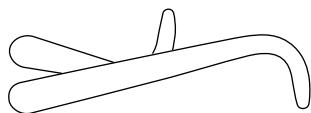

6 x 6

lange Zähne links
long teeth on left side
graf os largos a la izquierda

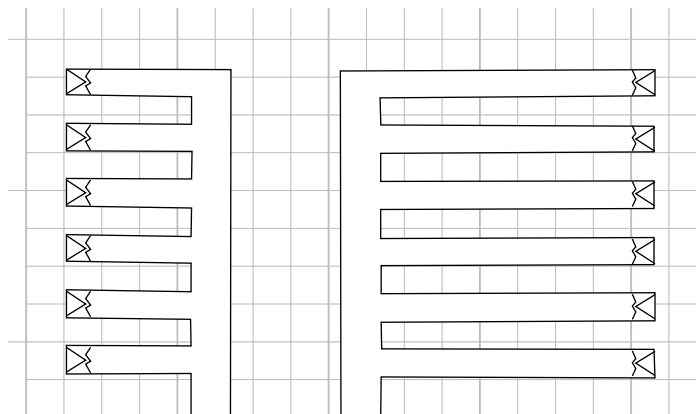

070-561-02

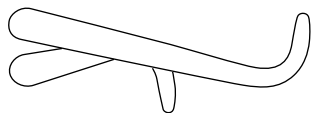

6 x 6

lange Zähne rechts
long teeth on right side
graf os largos a la derecha

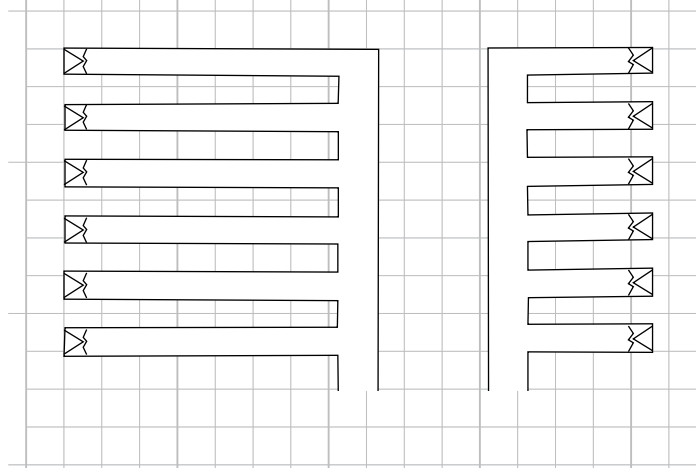

1/1 0 mm 20 mm 40 mm 60 mm 80 mm

Wundspreizer
 self-retaining Retractors
 Separadores autoestáticos

Art.Nr.	Beschreibung Description	Size	Spez.
070-572-33	BECKMANN-EATON scharf sharp agudo	32,0cm; 12 5/8"	

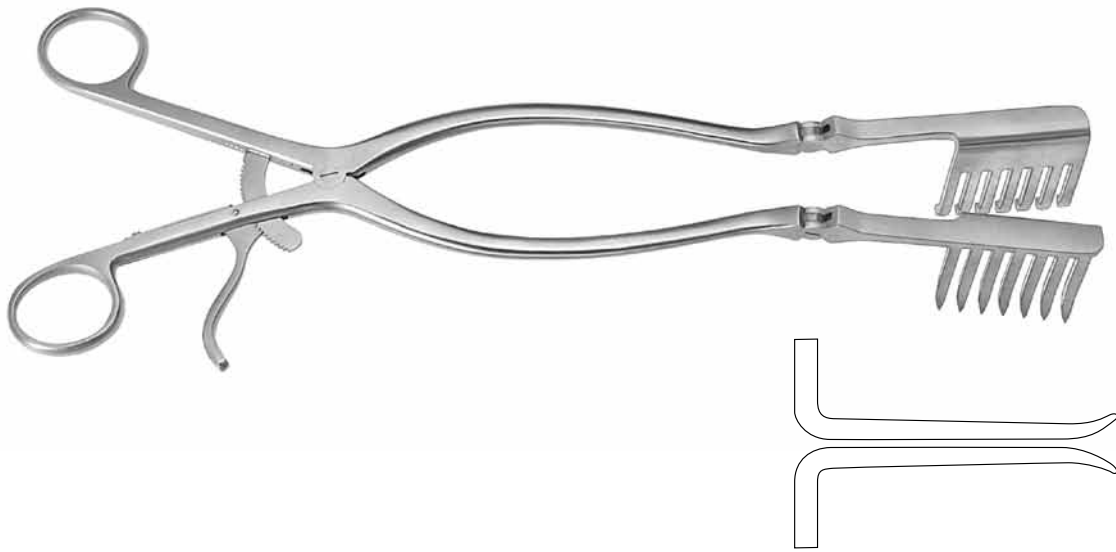

7 x 7

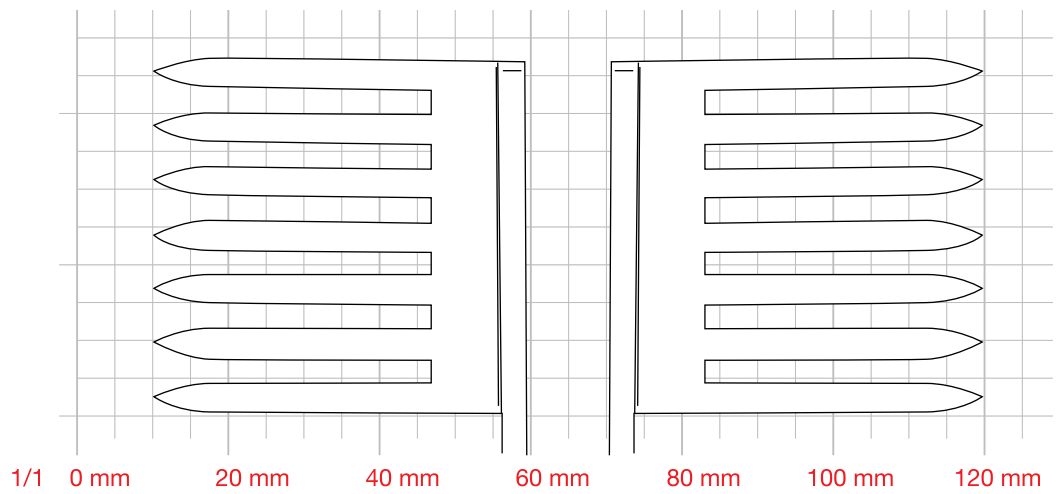

Wundspreizer
self-retaining Retractors
Separadores autoestáticos



Art.Nr.	Beschreibung Description	Size	Spez.
070-690-31	BECKMANN scharf sharp agudo	31,0cm; 12 2/8"	

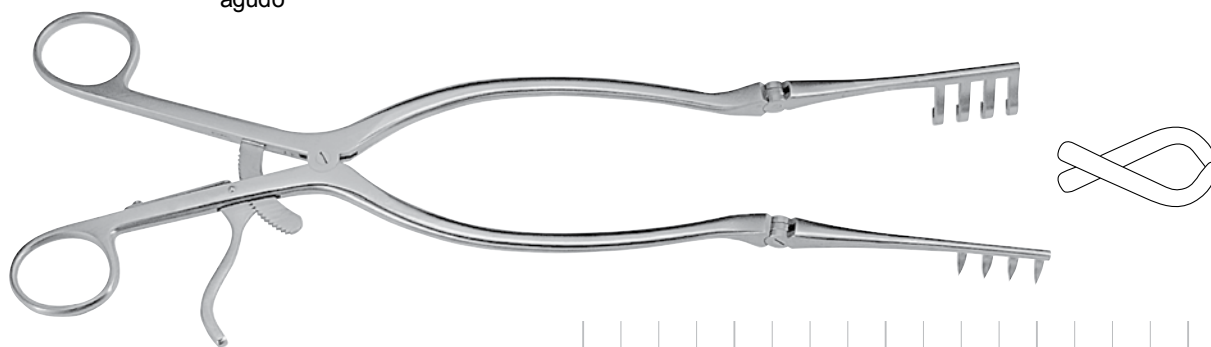

4 x 4

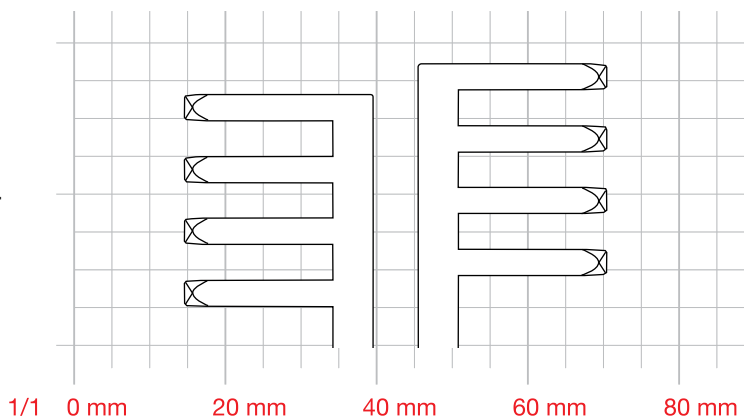

1/1 0 mm 20 mm 40 mm 60 mm 80 mm

070-691-32	ADSON stumpf blunt romo	32,0cm; 12 5/8"	
------------	------------------------------	-----------------	--

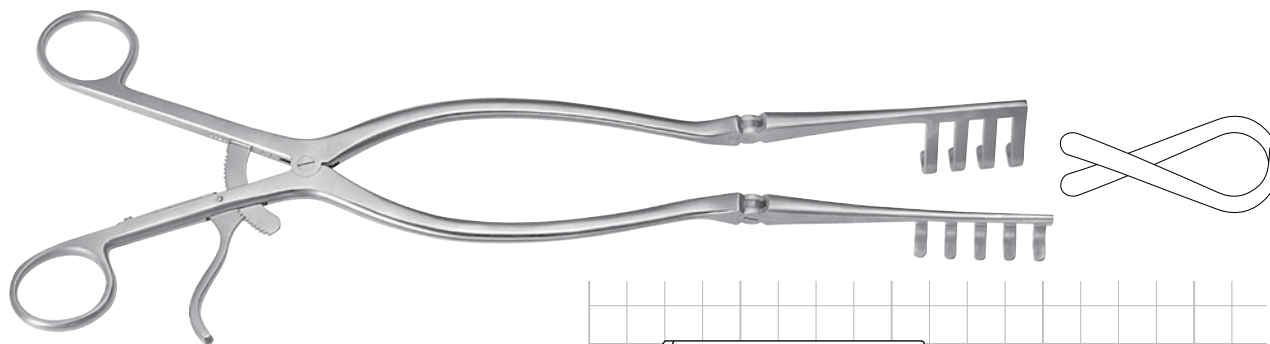

5 x 4

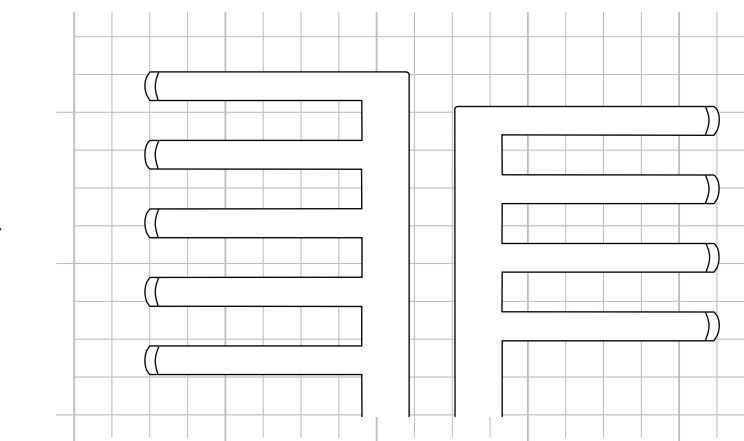

1/1 0 mm 20 mm 40 mm 60 mm 80 mm

070

Wundspreizer
self-retaining Retractors
Separadores autoestáticos

Art.Nr.	Beschreibung Description	Size	Spez.
---------	----------------------------	------	-------

	BECKMANN-ADSON scharf sharp agudo	31,0cm; 12 2/8"	
--	--	-----------------	--

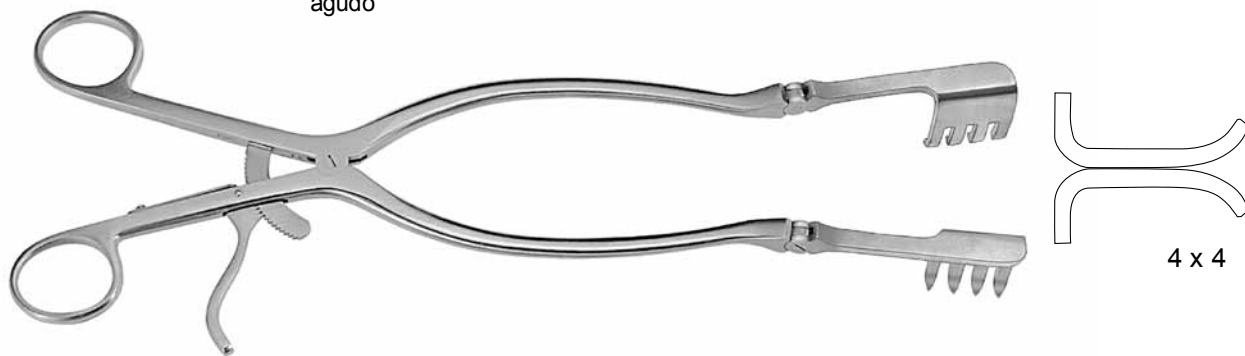

070-870-01	25 x 25 mm	
------------	------------	--

070-870-02	25 x 31 mm	
------------	------------	--

070-870-03	25 x 40 mm	
------------	------------	--

070-870-04	25 x 45 mm	
------------	------------	--

1/1 0 mm 20 mm 40 mm 60 mm 80 mm 100 mm 120 mm

Wundspreizer
self-retaining Retractors
Separadores autoestáticos



Art.Nr.	Beschreibung Description	Size	Spez.
---------	----------------------------	------	-------

	BECKMANN-ADSON stumpf blunt romo	31,0cm; 12 2/8"	
--	---------------------------------------	-----------------	--

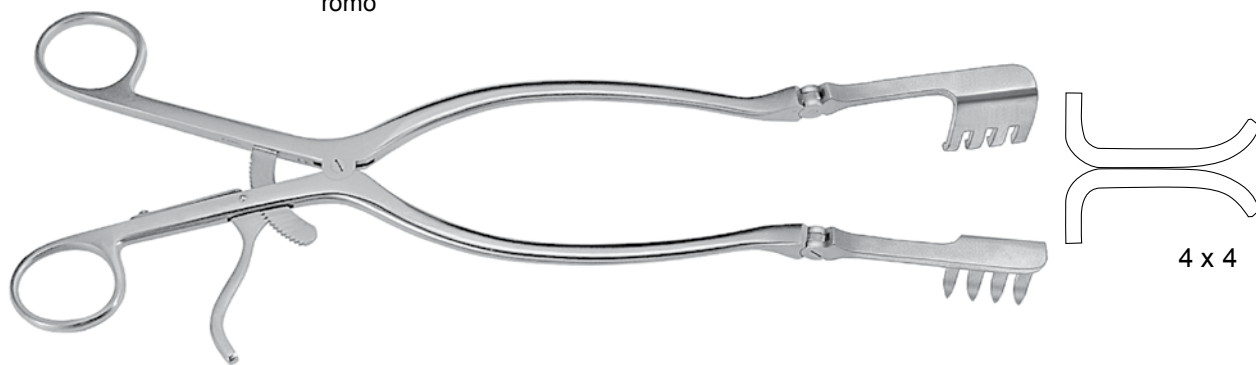

070-871-01	25 x 25 mm	
------------	------------	--







070-871-02	25 x 31 mm	
------------	------------	--

070-871-03	25 x 40 mm	
------------	------------	--

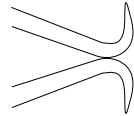
070-871-04	25 x 45 mm	
------------	------------	--

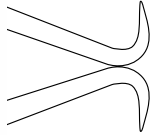
1/1 0 mm 20 mm 40 mm 60 mm 80 mm 100 mm 120 mm

Wundspreizer
self-retaining Retractors
Separadores autoestáticos

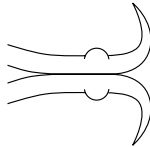
Art.Nr.	Beschreibung Description	Size	Spez.
GELPI			
070-202-09	9,0cm; 3 1/2"		
070-202-11	11,0cm; 4 3/8"		
070-202-14	13,5cm; 5 3/8"		
GELPI			
070-202-19	19,0cm; 7 4/8"		
DE BAKEY			
070-240-10	10,0cm; 3 7/8"		
070-240-14	14,0cm; 5 4/8"		
GELPI-LOKTITE			
070-250-19	19,0cm; 7 4/8"		

Wundspreizer
self-retaining Retractors
Separadores autoestáticos



Art.Nr. Beschreibung | Description Size Spez.

HENLEY

16,5cm; 6 4/8"

SET



scharf | sharp
agudo

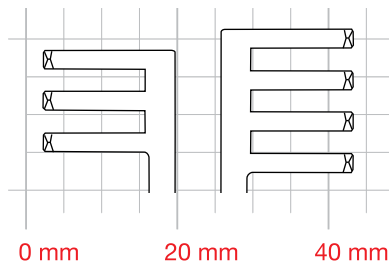

1/1 0 mm 20 mm 40 mm

070-300-00

HENLEY

070-300-00

HENLEY

Wundspreizer, bestehend aus:
070-300-16 1 Sperrer, scharf
070-300-19 1 gezahnte Mittelvalve 19 x 16 mm
070-300-25 1 gezahnte Mittelvalve 25 x 16 mm
070-300-32 1 gezahnte Mittelvalve 30 x 16 mm

Separador, compuesto de:
070-300-16 1 Separador, agudas
070-300-19 1 Valva central, dentada, 19 x 16 mm
070-300-25 1 Valva central, dentada, 25 x 16 mm
070-300-32 1 Valva central, dentada, 30 x 16 mm

070-300-00

HENLEY

Self-retaining retractor, consisting of:
070-300-16 1 Spreader, sharp
070-300-19 1 Central valve, serrated, 19 x 16 mm
070-300-25 1 Central valve, serrated, 25 x 16 mm
070-300-32 1 Central valve, serrated, 30 x 16 mm

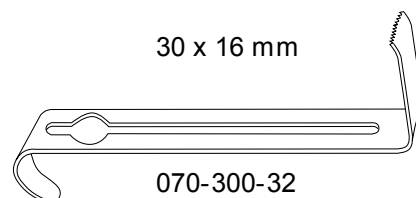
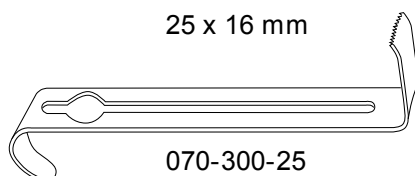
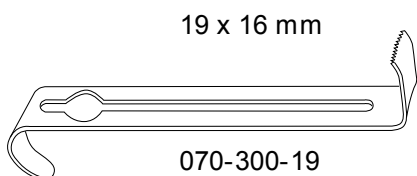

Wundspreizer
self-retaining Retractors
Separadores autoestáticos

Art.Nr. Beschreibung | Description Size Spez.

HENLEY

16,5cm; 6 4/8"

SET

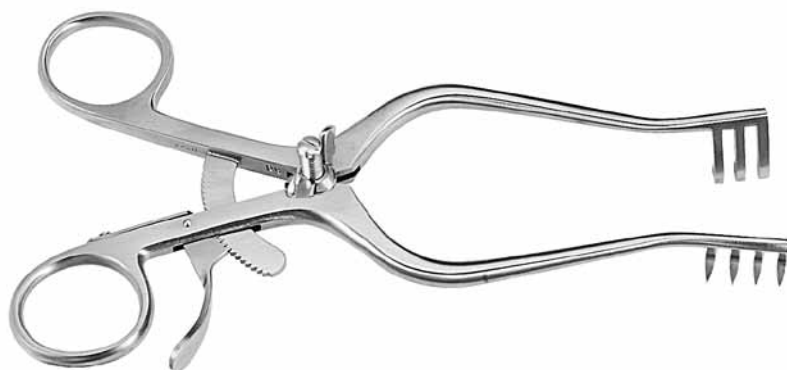

stumpf | blunt
romo

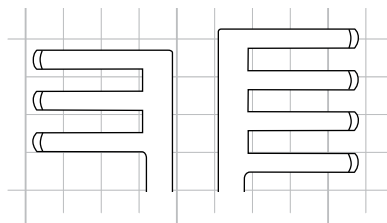

1/1 0 mm 20 mm 40 mm

070-301-00

HENLEY

Wundspreizer, bestehend aus:

- 070-301-16 1 Sperrer, stumpf
- 070-300-19 1 gezahnte Mittelvalve 19 x 16 mm
- 070-300-25 1 gezahnte Mittelvalve 25 x 16 mm
- 070-300-32 1 gezahnte Mittelvalve 30 x 16 mm

070-301-00

HENLEY

Separador, compuesto de:

- 070-301-16 1 Separador, romo
- 070-300-19 1 Valva central, dentada, 19 x 16 mm
- 070-300-25 1 Valva central, dentada, 25 x 16 mm
- 070-300-32 1 Valva central, dentada, 30 x 16 mm

070-301-00

HENLEY

Self-retaining retractor, consisting of:

- 070-301-16 1 Spreader, blunt
- 070-300-19 1 Central valve, serrated, 19 x 16 mm
- 070-300-25 1 Central valve, serrated, 25 x 16 mm
- 070-300-32 1 Central valve, serrated, 30 x 16 mm

19 x 16 mm

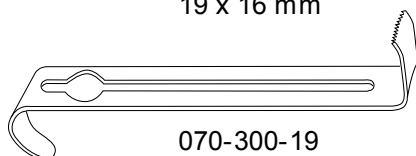

070-300-19

25 x 16 mm

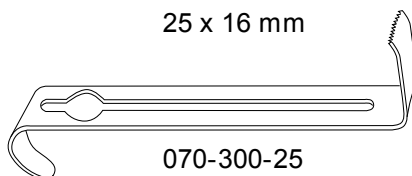

070-300-25

30 x 16 mm

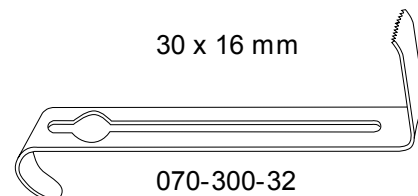

070-300-32

070

Weitere Artikel
further items
más artículos



Art.Nr.	Beschreibung Description	Size	Spez.
Other items available but not illustrated			
070-202-16	GELPI selfretaining Retractor sharp	16,0cm; 6,4"	
070-202-19S	sharp; sand blasted	19,0cm; 7,6"	
070-203-10	JOHNSON Neuroma Retractor small with flat tips, brushed satin	10,0cm; 4"	
070-203-14	with flat tips, brushed satin	14,0cm; 5 1/2"	
070-204-17	SELETZ-GELPI selfretaining Retractor; sharp	17,0cm; 6,8"	
070-206-30	Orthopeadic GELPI Retraktor; sharp	30,0cm; 12"	
070-208-11	HENDREN Self-reaining retractor blunt	11,0cm; 3,5"	
070-209-13	blunt	13,5cm; 5,5"	
070-401-22	NORFOLK AND NORWICH Retractor; blunt; 4X5 teeth	22,0cm; 8,8"	
070-411-17	JACKSON BURROWS selfretaining Retractor; blunt	17,5cm; 7"	
070-430-15	JOLL (FRIEDMAN) selfretaining Retractor; sharp	15,5cm; 6,2"	
070-482-03	MEYERDING selfretaining Retractor Blades 60X19mm; toothed	20,0cm; 8"	
070-483-01	fig. 1; left	18,0cm; 7,2"	
070-483-02	fig. 2; right	18,0cm; 7,2"	
070-484-01	WILLIAMS selfretaining Retractor 50x10mm; right	20,0cm; 8"	
070-484-02	50x20mm; right		
070-484-03	70x10mm; right		
070-484-04	70x20mm; right		
070-484-11	50x10mm; left		
070-484-12	50x20mm; left		
070-484-13	70x10mm; left		
070-484-14	70x20mm; left		
070-486-01	RIGHBY selfretaining Retractor Blades 35X20mm	18,0cm; 7,2"	
070-486-02	Blades 60X20mm		
070-486-03	Blades 65X15mm		
070-487-01	DARLING selfretaining Retractor fig. 1; 57X25mm; 70X38mm toothed	18,0cm; 7,2"	
070-487-02	fig. 2; 70X38mm; 57X25mm toothed		
070-494-16	TÜBINGER MODELL selfretaining Retractor	16,0cm; 6,4"	
070-494-18		18,0cm; 7,2"	

070

Weitere Artikel
further items
más artículos

Art.Nr.	Beschreibung Description	Size	Spez.
Other items available but not illustrated			
070-499-01 070-499-02	WALTON selfretaining Retractor right left	18,0cm; 7,2"	
070-500-01 070-500-02	KNIGHTON selfretaining Retractor right left	18,0cm; 7,2"	
070-510-18	KOLBEL selfretaining retractor; blunt; 2X2 teeth	18,0cm; 7"	
070-538-13 070-539-13	MILLIGAN selfretaining retractor sharp; 3X3 teeth blunt; 3X3 teeth	13,0cm; 5,2"	
070-540-21	TRAVERS selfretaining Retractor; blunt; 4X5 teeth	21,0cm; 8,4"	
070-552-22 070-553-22	MISKIMON selfretaining Retractor sharp; 7X7 teeth blunt; 7X7 teeth	22,0cm; 8,8"	
070-559-27	ADSON selfretaining Retractor; sharp; 6X6 teeth	27,0cm; 10,8"	
070-600-01 070-600-02 070-600-03 070-600-04 070-600-05 070-600-06	FARR selfretaining Retractor sharp sharp sharp sharp sharp flat blades	3,8cm; 1,5" 5,0cm; 2" 5,8cm; 2,3" 6,4cm; 2,5" 7,5cm; 3" 6,4cm; 2,5"	
070-614-01 070-614-02	selfretaining Retractor sharp; 4X4 teeth blunt; 4X4 teeth	10,0cm; 4"	
070-632-10 070-633-10	JANSEN selfretaining Retractor sharp; 4X4 teeth blunt; 4X4 teeth	10,0cm; 4"	
070-650-10 070-651-10	WEITLANER-LOKTITE Retractor sharp; 2X3 teeth; selfretaining blunt; 2X3 teeth; selfretaining	10,5cm; 4,2"	
070-668-13 070-669-13 070-670-10S 070-670-13S 070-670-16S 070-670-20S 070-670-26 070-671-10S	WEITLANER selfretaining Retractor sharp; 3X4 teeth blunt; 3X4 teeth sharp; 2X3 teeth; sand blasted sharp; 3X4 teeth; sand blasted sharp; 3X4 teeth; sand blasted sharp; 3X4 teeth; sand blasted sharp; 5x6 teeth blunt; 2X3 teeth; sand blasted	13,0cm; 5,2" 13,0cm; 5,2" 10,5cm; 4,2" 13,0cm; 5,2" 16,5cm; 6,6" 20,0cm; 8" 26,0cm; 10,4" 10,5cm; 4,2"	

Weitere Artikel
further items
más artículos



Art.Nr.	Beschreibung Description	Size	Spez.
Other items available but not illustrated			
070-671-13S	blunt; 3X4 teeth; sand blasted	13,0cm; 5,2"	
070-671-16S	blunt; 3X4 teeth; sand blasted	16,5cm; 6,6"	
070-671-20S	blunt; 3X4 teeth; sand blasted	20,0cm; 8"	
070-671-26	blunt; 5x6 teeth	26,0cm; 10,4"	
PLESTER selfretaining Retractor			
070-672-13	left	13,0cm; 5,2"	
070-673-13	right		
MOLLISON selfretaining Retractor; blunt; 4X4 teeth			
070-675-15		15,0cm; 6"	
ADSON selfretaining Retractor			
070-680-20	sharp; 4X4 teeth	20,0cm; 8"	
070-681-20	blunt; 4X4 teeth; curved		
ADSON-BABY selfretaining Retractor			
070-684-13	sharp; 3X4 teeth	13,5cm; 5,4"	
070-684-16	sharp; 3X4 teeth	16,0cm; 6,4"	
070-685-13	blunt; 3X4 teeth	13,5cm; 5,4"	
070-685-16	blunt; 3X4 teeth	16,0cm; 6,4"	
BECKMANN selfretaining Retractor			
070-690-32	sharp; 4X5 teeth	33,0cm; 13,2"	
070-691-31	blunt; 4X5 teeth	31,0cm; 12,4"	
SCHUHKNECHT selfretaining Retractor			
070-800-12	sharp; 3X3 teeth	12,5cm; 5"	
070-800-14	sharp; 3X4 teeth	14,0cm; 5,6"	
070-801-12	blunt; 3X3 teeth	12,5cm; 5"	
070-801-14	blunt; 3X4 teeth	14,0cm; 5,6"	
WULLSTEIN selfretaining Retractor			
070-810-10	sharp; 3X3 teeth	10,5cm; 4,2"	
070-810-16	sharp; 3X3 teeth	16,0cm; 6,4"	
070-810-18	sharp; 3X3 teeth	18,0cm; 7,2"	
070-811-10	blunt; 3X4 teeth	10,5cm; 4,2"	
070-811-16	blunt; 3X4 teeth	16,0cm; 6,4"	
070-811-18	blunt; 3X4 teeth	18,0cm; 7,2"	
MAYO-ADAMS selfretaining Retractor			
070-822-17	blunt; 2X2 teeth; Retractor only	17,0cm; 6,8"	
BECKMANN-ADSON selfretaining Retractor			
070-871-01S	sand blasted; blunt; 4X4 teeth; 25X25mm	31,0cm; 12,4"	
WEITLANER, RETRACTOR, HINGED BLADES			
070-880-16	3x4 sharp prongs, 18mm deep	16,0cm; 6,4"	
070-880-20	3x4 sharp prongs, 20mm deep	20,0cm; 8"	
070-881-14	3x4 blunt prongs, 18mm deep	14,0cm; 5,6"	
070-881-16	3x4 blunt prongs, 18mm deep	16,0cm; 6,4"	

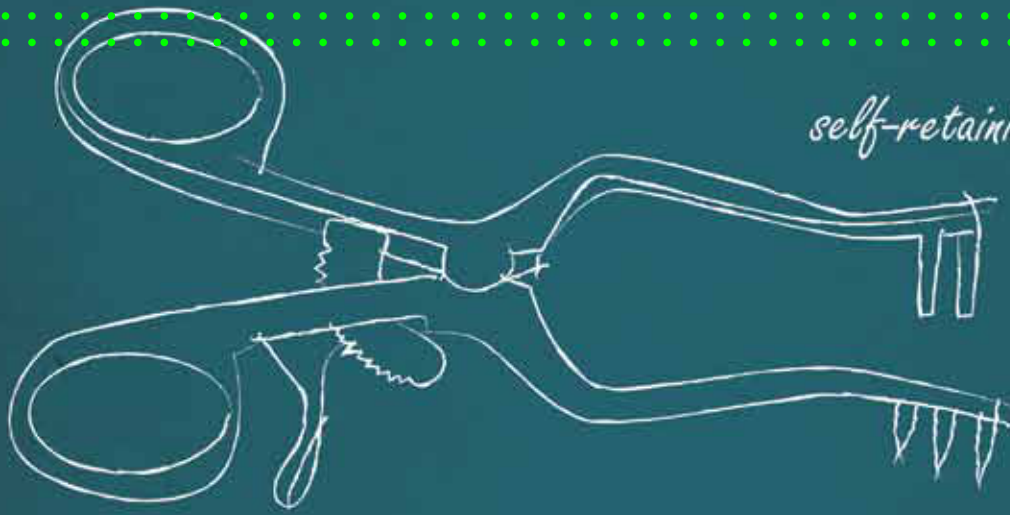

self-retaining Retractors

abdominal spatulas

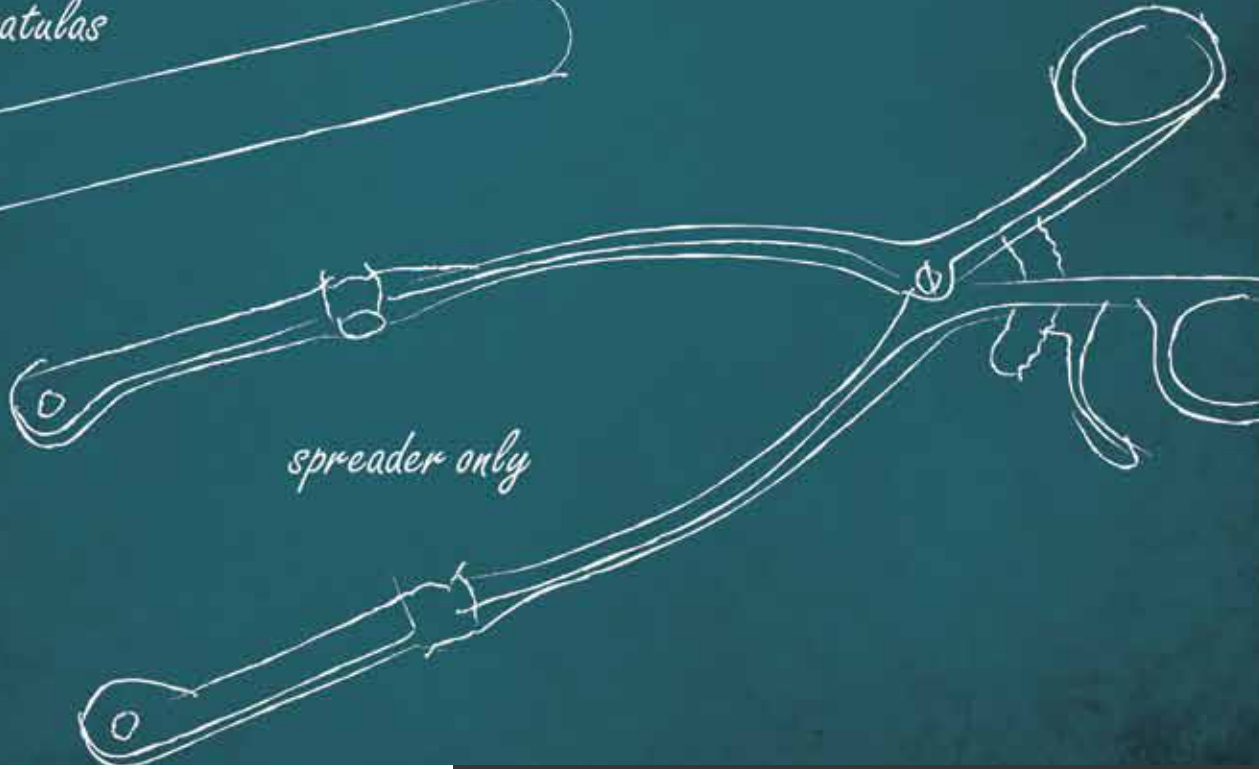

spreader only

Bauchdeckenhalter
Abdominal Retractors

074

Bauchdeckenhalter
Abdominal Retractors
Separadores abdominales



Art.Nr.

Art.Nr.

RICARD

SET



074-310-28

074-312-30

Bauchdeckenhalter, bestehend aus:
074-310-00 1 Sperrer
074-399-14 1 Paar Seitenvlaven 72 x 85 mm
074-310-03 1 Mittelvalve 80 x 90 mm

Bauchdeckenhalter, bestehend aus:
074-310-00 1 Sperrer
074-399-23 1 Paar Seitenvlaven 60 x 80 mm
074-310-02 1 Mittelvalve 55 x 70 mm

Abdominal retractor, consisting of:
074-310-00 1 Spreader
074-399-14 1 Pair lateral valves 72 x 85 mm
074-310-03 1 Central valve 80 x 90 mm

Abdominal retractor, consisting of:
074-310-00 1 Spreader
074-399-23 1 Pair lateral valves 60 x 80 mm
074-310-02 1 Central valve 55 x 70 mm

Separador abdominal, compuesto de:
074-310-00 1 Separador
074-399-14 1 Par de valvas laterales 72 x 85 mm
074-310-03 1 Valva central 80 x 90 mm

Separador abdominal, compuesto de:
074-310-00 1 Separador
074-399-23 1 Par de valvas laterales 60 x 80 mm
074-310-02 1 Valva central 55 x 70 mm

074

Mittelvalven
central valves
valvas centrales

074-310-02 55 x 70 mm
074-310-03 80 x 90 mm



Bauchdeckenhalter
 Abdominal Retractors
 Separadores abdominales

Art.Nr. Beschreibung | Description

COLLIN-BABY

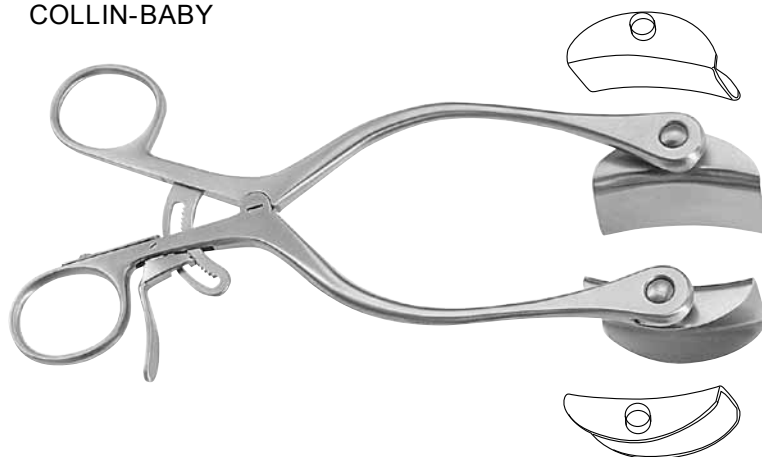

SET

074-330-18 18,0cm; 6 1/8"

Bauchdeckenhalter, bestehend aus:

- 1 Sperrer
- 074-330-23 1 Paar Seitenvalven 23 x 44 mm
- 074-330-30 1 Paar Seitenvalven 30 x 44 mm

Abdominal retractor, consisting of:

- 1 Spreader
- 074-330-23 1 Pair lateral valves 23 x 44 mm
- 074-330-30 1 Pair lateral valves 30 x 44 mm

Separador abdominal, compuesto de:

- 1 Separador
- 074-330-23 1 Par de valvas laterales 23 x 40 mm
- 074-330-30 1 Par de valvas laterales 30 x 44 mm

Seitenvalven; 1 Paar
 Lateral valves; 1 pair
 Valvas laterales; 1 par

SET

074-330-23 23 x 44 mm

074-330-30 30 x 44 mm

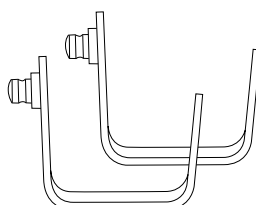

Bauchdeckenhalter
Abdominal Retractors
Separadores abdominales



Art.Nr.

Art.Nr.

COLLIN

SET



074-330-24

23,5cm; 9 1/4"

Bauchdeckenhalter, bestehend aus:

- 1 Sperrer
- 1 Paar Seitenvlaven 32 x 62 mm
- 1 Mittelvalve 55 x 55 mm

074-398-10
074-331-01

Abdominal retractor, consisting of:

- 1 Spreader
- 1 Pair lateral valves 32 x 62 mm
- 1 Central valve 55 x 55 mm

074-398-10
074-331-01

Separador abdominal, compuesto de:

- 1 Separador
- 1 Par de valvas laterales 32 x 62 mm
- 1 Valva central 55 x 55 mm

074-398-10
074-331-01

074-332-24

23,5cm; 9 1/4"

Bauchdeckenhalter, bestehend aus:

- 1 Sperrer
- 1 Paar Seitenvlaven 38 x 80 mm
- 1 Mittelvalve 55 x 65 mm

074-398-11
074-331-02

Abdominal retractor, consisting of:

- 1 Spreader
- 1 Pair lateral valves 38 x 80 mm
- 1 Central valve 55 x 65 mm

074-398-11
074-331-02

Separador abdominal, compuesto de:

- 1 Separador
- 1 Par de valvas laterales 38 x 80 mm
- 1 Valva central 55 x 65 mm

074-398-11
074-331-02

Mittelvalven
Central valves
Valvas centrales

074-331-01

55 x 55 mm

074-331-02

55 x 65 mm

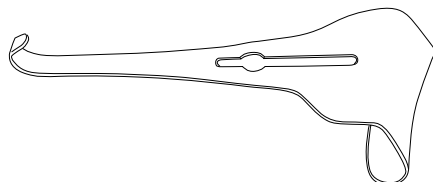

Art.Nr. Beschreibung | Description

COLLIN

SET



074-334-24 23,5cm; 9 1/4"

Bauchdeckenhalter, bestehend aus:

- 074-398-13 1 Sperrer
- 074-331-03 1 Paar Seitenvalven 38 x 100 mm
- 074-331-03 1 Paar Seitenvalven 55 x 75 mm

Abdominal retractor, consisting of:

- 074-398-13 1 Spreader
- 074-331-03 1 Pair lateral valves 38 x 100 mm
- 074-331-03 1 Pair lateral valves 55 x 75 mm

Separador abdominal, compuesto de:

- 074-398-13 1 Separador
- 074-331-03 1 Par de valvas laterales 38 x 100 mm
- 074-331-03 1 Par de valvas laterales 55 x 75 mm

Mittelvalven
 Central valves
 Valvas centrales

074-331-03 55 x 75 mm

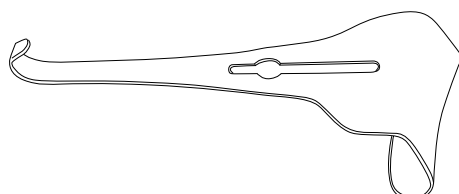

Valven für Bauchdeckenhalter
 Valves for abdominal retractors
 Valvas para separadores abdominales



Art.Nr.	Beschreibung Description	Size	Spez.
---------	----------------------------	------	-------

COLLIN Seitenvlaven
 Lateral valves
 Valvas laterales

SET

- 074-398-10 32 x 62 mm
- 074-398-11 38 x 80 mm
- 074-398-12 38 x 100 mm
- 074-398-13 60 x 80 mm

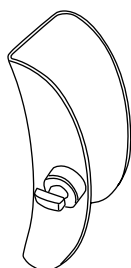

Seitenvlaven
 Lateral valves
 Valvas laterales

SET

- 074-399-01 38 x 62 mm
- 074-399-02 40 x 80 mm
- 074-399-03 60 x 80 mm

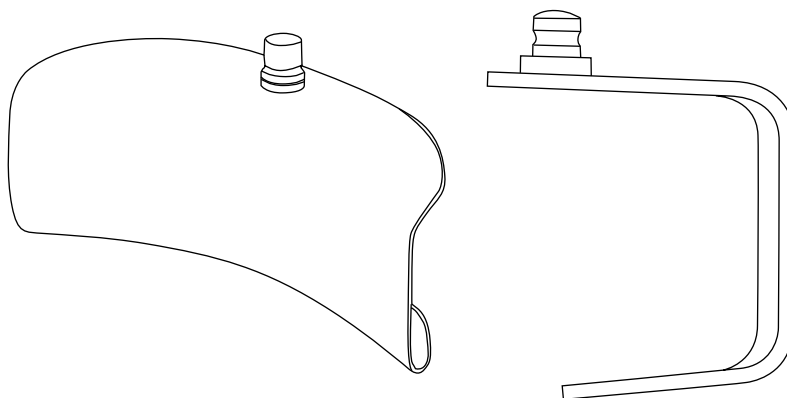

Seitenvlaven
 Lateral valves
 Valvas laterales

SET

- 074-399-10 50 x 58 mm
- 074-399-14 72 x 85 mm
- 074-399-23 60 x 80 mm

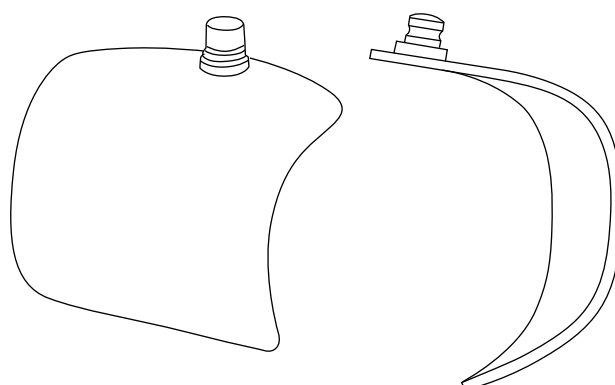

074

Bauchdeckenhalter
Abdominal Retractors
Separadores abdominales

Art.Nr.	Beschreibung Description	Size	Spez.
074-400-10	GOSSET-BABY	12,5cm; 4 7/8"	



Spreizweite
Spreading
Extensión

100 mm

Seitenvalven
Lateral valves
Valvas laterales

40 x 30 mm

074-412-14	GOSSET	18,5cm; 7 2/8"	
------------	--------	----------------	--

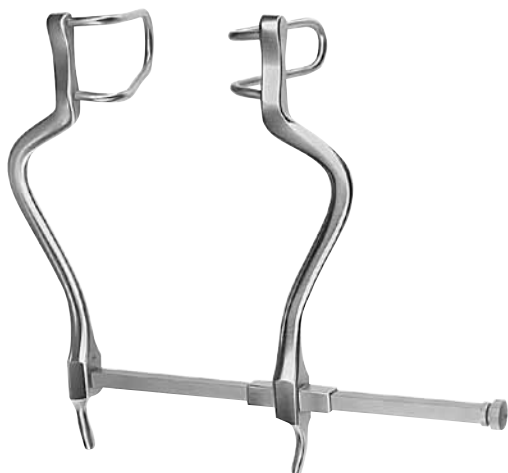

Spreizweite
Spreading
Extensión

140 mm

Seitenvalven
Lateral valves
Valvas laterales

63 x 35 mm

074-414-16	GOSSET	16,5cm; 6 4/8"	
------------	--------	----------------	--

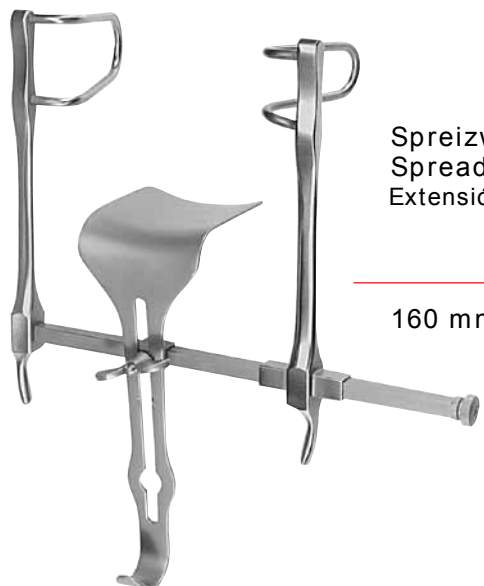

Spreizweite
Spreading
Extensión

160 mm

Seitenvalven
Lateral valves
Valvas laterales

63 x 35 mm

Mittelvalve
Central valve
Valva central

60 x 56 mm

Bauchdeckenhalter
Abdominal Retractors
Separadores abdominales



Art.Nr.	Beschreibung Description	Size	Spez.
074-760-09	BALFOUR-BABY	12,5cm; 4 7/8"	

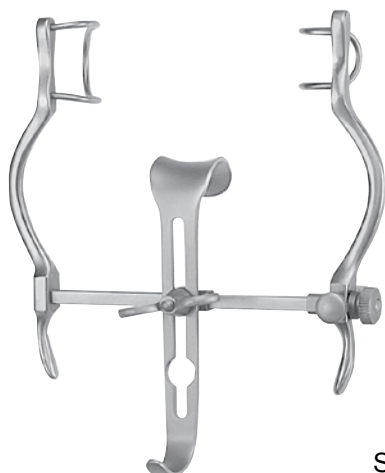

Spreizweite
Spreading
Extensión

Seitenvalven
Lateral valves
Valvas laterales

Mittelvalve
Central valve
Valva central

90 mm

38 mm

25 x 23 mm

074-764-18	BALFOUR	20,0cm; 7 7/8"	
------------	---------	----------------	--

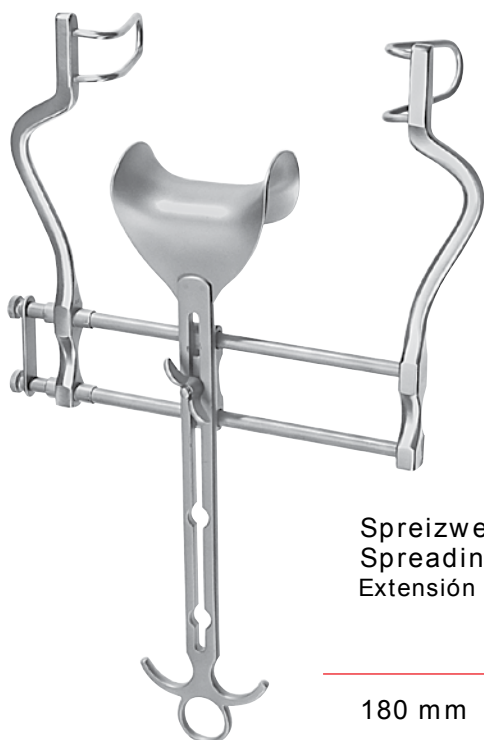

Spreizweite
Spreading
Extensión

Seitenvalven
Lateral valves
Valvas laterales

Mittelvalve
Central valve
Valva central

180 mm

63 x 35 mm

50 x 75 mm

074

Bauchdeckenhalter
 Abdominal Retractors
 Separadores abdominales

Art.Nr.	Beschreibung Description	Size	Spez.
074-768-20	BALFOUR	20,0cm; 7 7/8"	



Spreizweite
 Spreading
 Extensión

Seitenvalven
 Lateral valves
 Valvas laterales

Mittelvalve
 Central valve
 Valva central

200 mm

100 x 35 mm

100 x 60 mm

074-768-25	BALFOUR	20,0cm; 7 7/8"	
------------	---------	----------------	--

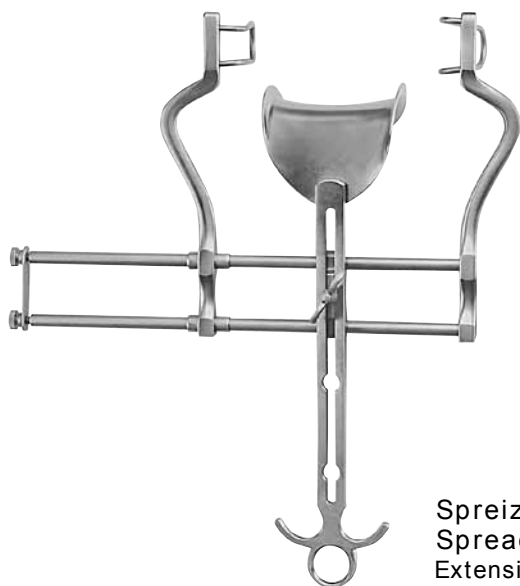

Spreizweite
 Spreading
 Extensión

Seitenvalven
 Lateral valves
 Valvas laterales

Mittelvalve
 Central valve
 Valva central

250 mm

100 x 35 mm

70 x 85 mm

Bauchdeckenhalter
Abdominal Retractors
Separadores abdominales



Art.Nr.	Beschreibung Description	Size	Spez.
074-772-25	BALFOUR US-TYPE	20,0cm; 7 7/8"	

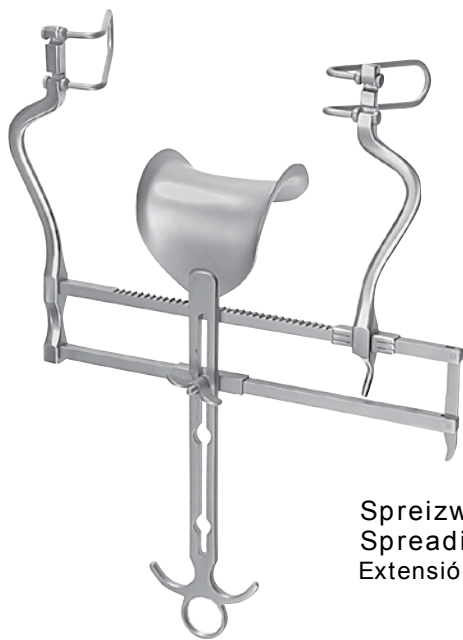

Spreizweite
Spreading
Extensión

Seitenvalven
Lateral valves
Valvas laterales

Mittelvalve
Central valve
Valva central

250 mm

60 x 35 mm
80 x 35 mm

70 x 85 mm

Seitenvalven
Lateral valves
Valvas laterales

SET

074-772-01

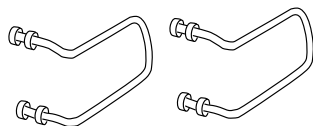

60 x 35 mm

074-772-02

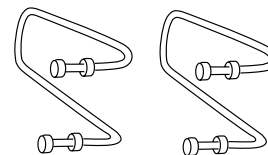

80 x 35 mm

BALFOUR

074-799-60

100 x 60 mm

074-799-70

100 x 70 mm

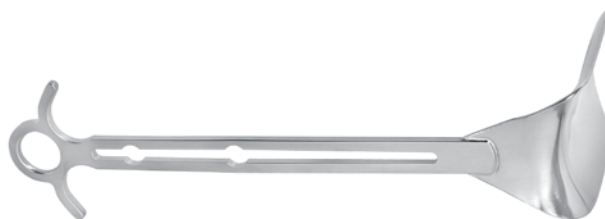

Bauchdeckenhalter
Abdominal Retractors
Separadores abdominales

Art.Nr.	Beschreibung Description	Size	Spez.
	BALFOUR Mittelvalven Central valves Valvas centrales		

074-798-01 50 x 75 mm

074-798-02 70 x 85 mm

074-798-03 40 x 68 mm



074-870-00 O'SULLIVAN-O'CONNOR

SET



Bauchdeckenhalter, bestehend aus:
074-870-01 1 Rahmen mit 2 Seitenvalven 62 x 25 mm
074-870-11 2 Valven 80 x 45 mm
074-870-12 1 Valve 110 x 70 mm

Abdominal retractor, consisting of:
074-870-01 1 Frame with 2 lateral valves 62 x 25 mm
074-870-11 2 Valves 80 x 45 mm
074-870-12 1 Valve 110 x 70 mm

Separador abdominal, compuesto de:
074-870-01 1 Cuadro con 2 valvas laterales 62 x 25 mm
074-870-11 2 Valvas 80 x 45 mm
074-870-12 1 Valva 110 x 70 mm

Bauchdeckenhalter
Abdominal Retractors
Separadores abdominales



Art.Nr.	Beschreibung Description	Size	Spez.
074-880-00	KIRSCHNER		

SET

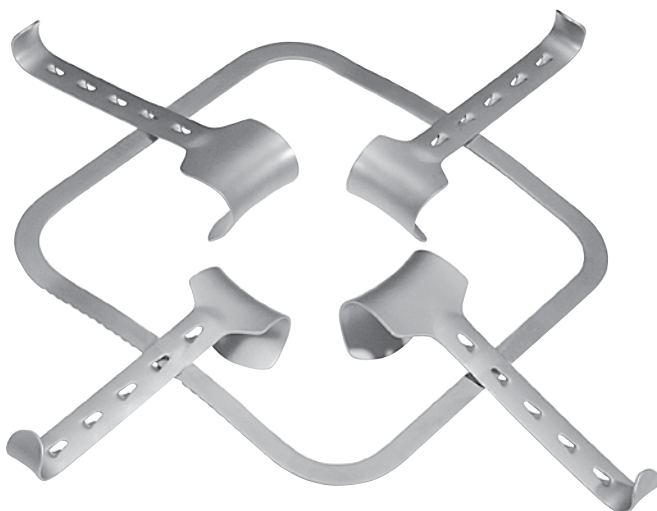

074-880-01 Bauchdeckenhalter, bestehend aus:
1 starrer Rahmen 240 x 240 mm
074-880-13 2 Valven 40 x 55 mm
074-880-14 2 Valven 50 x 65 mm

074-880-01 Abdominal retractor, consisting of:
1 Fixed frame 240 x 240 mm
074-880-13 2 Valves 40 x 55 mm
074-880-14 2 Valves 50 x 65 mm

074-880-01 Separador abdominal, compuesto de:
1 Cuadro fijo 240 x 240 mm
074-880-13 2 Valvas 40 x 55 mm
074-880-14 2 Valvas 50 x 65 mm

074

Bauchdeckenhalter
Abdominal Retractors
Separadores abdominales

Art.Nr.	Beschreibung Description	Size	Spez.
074-884-00	KIRSCHNER		SET

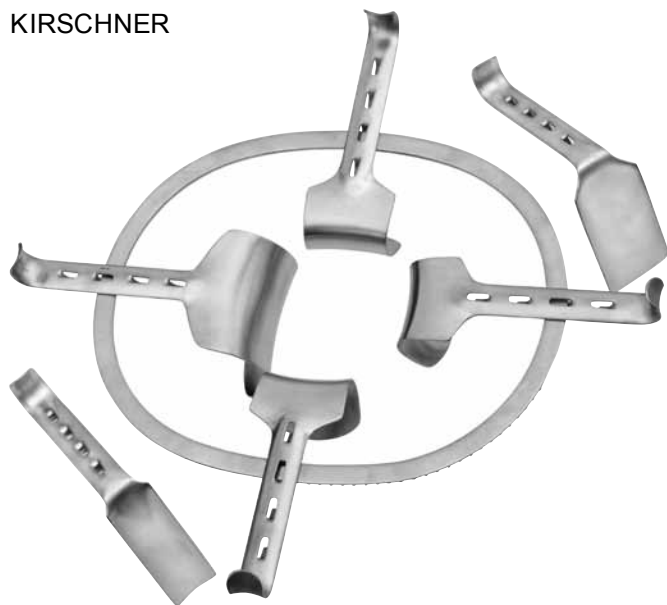

Bauchdeckenhalter, bestehend aus:

- 074-884-01 1 starrer Rahmen 300 x 240 mm
- 074-880-14 3 Valven 50 x 65 mm
- 074-880-15 1 Valve 80 x 90 mm
- 074-880-20 1 Valve 98 x 50 mm
- 074-880-21 1 Valve 105 x 35 mm

Abdominal retractor, consisting of:

- 074-884-01 1 Fixed frame 300 x 240 mm
- 074-880-14 3 Valves 50 x 65 mm
- 074-880-14 1 Valve 80 x 90 mm
- 074-880-20 1 Valve 98 x 50 mm
- 074-880-21 1 Valve 105 x 35 mm

Separador abdominal, compuesto de:

- 074-884-01 1 Cuadro fijo 300 x 240 mm
- 074-880-13 3 Valvas 50 x 65 mm
- 074-880-14 1 Valva 80 x 90 mm
- 074-880-20 1 Valva 98 x 50 mm
- 074-880-21 1 Valva 105 x 35 mm

Valven für Bauchdeckenhalter
 Valves for abdominal retractors
 Valvas para separadores abdominales



Art.Nr.	Beschreibung Description	Size	Spez.
---------	----------------------------	------	-------

KIRSCHNER

- 074-880-11 60 x 85 mm
- 074-880-13 40 x 55 mm
- 074-880-14 50 x 65 mm
- 074-880-15 80 x 90 mm
- 074-880-16 90 x 65 mm
- 074-880-17 98 x 95 mm

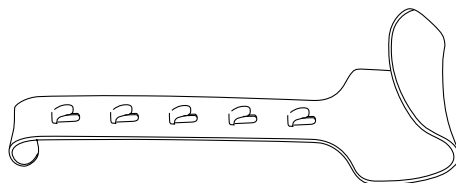

KIRSCHNER

- 074-880-20 98 x 50 mm
- 074-880-21 105 x 35 mm

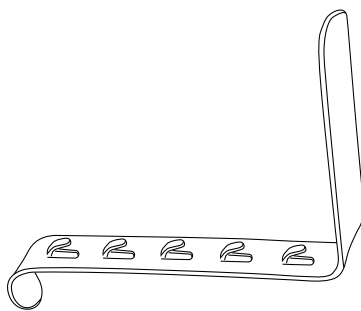

DOYEN

- 074-910-11 90 x 50 mm
- 074-910-12 105 x 50 mm
- 074-910-13 120 x 50 mm
- 074-910-14 135 x 50 mm



- 074-915-30 Kette mit Gewicht
Chain with weight
Cadena con pesa

645 g

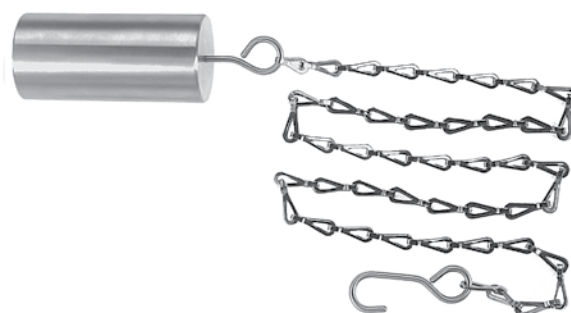

074

Bauchdeckenhalter
 Abdominal Retractors
 Separadores abdominales

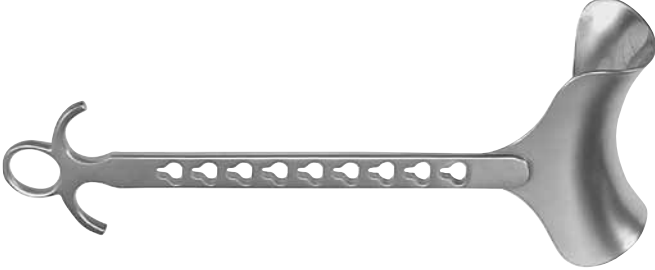
Art.Nr.	Beschreibung Description	Size	Spez.
	ROCHARD		
074-920-10	95 x 50 mm		
074-920-11	105 x 50 mm		
074-920-12	120 x 60 mm		
074-920-13	135 x 60 mm		
074-920-16	155 x 60 mm		

074-920-20	Fixiervorrichtung Fixation device Dispositivo de fijación	19,5cm; 7 3/4"	
			

Bauchdeckenhalter
 Abdominal Retractors
 Separadores abdominales



Art.Nr.	Beschreibung Description	Size	Spez.
	<p>Befestigungsgestell zur Fixierung an den Seitenschielen 25 x 10 mm der OP-Tische, zur Sterilisation zerlegbar</p> <p>Mounting frame for fastening to the lateral bars 25 x 10 mm of the operating tables, can be dismantled for sterilization</p> <p>Bastidor para la fijación a las barras laterales 25 x 10 mm de las mesas de operación, plegable para la esterilización</p>		

074-920-01 ROCHARD

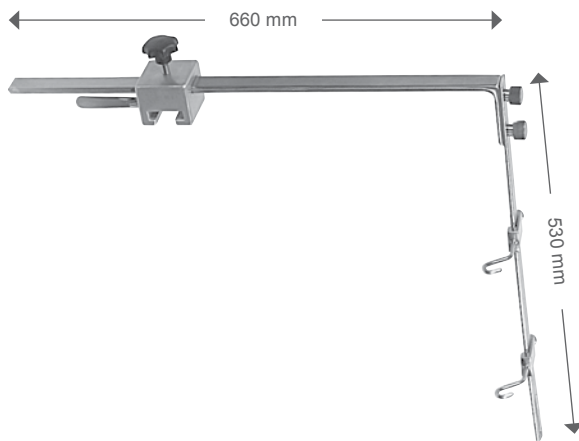

074-920-02 ROCHARD

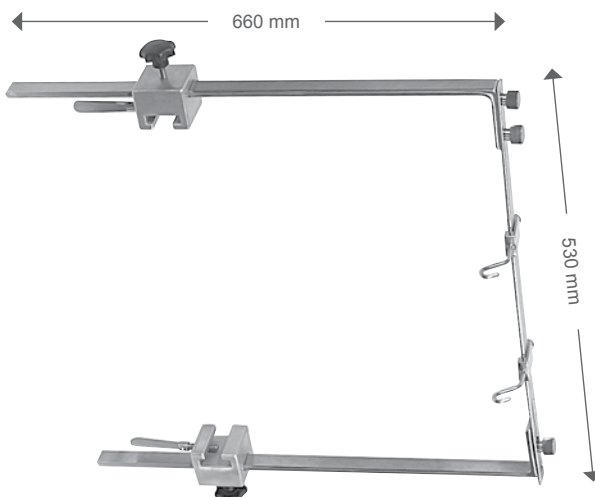

074

Weitere Artikel
further items
más artículos

Art.Nr.	Beschreibung Description	Size	Spez.
Other items available but not illustrated			
074-310-01	RICARD central blade; 65X50mm		
074-310-10	RICARD abdominal retractor Spreader only; spreading 280mm		
074-312-10	spreader only; spreading 300mm		
074-331-04	COLLIN central blade 38X80mm		
074-331-05	38X100mm		
074-334-00	COLLIN abdominal retractor; lateral blades 32X62mm		
074-336-00	COLLIN abdominal retractor complete central blade 62X67;lateral blades 50X58; spreading 160mm		
074-338-00	central blade 62X67;lateral blades 62X80; spreading 160mm		
074-340-00	central blade 50X75;lateral blades 38X80; spreading 100mm		
074-370-00	HOLZBACH abdominal retractor complete; central blade 74X82;lateral blades 59X80; spreading 275mm		
074-370-01	HOLZBACH abdominal retractor; spreader only; spreading 275mm		
074-370-05	HOLZBACH central blade; 74X82mm		
074-370-10	HOLZBACH lateral blade; 59X80mm		
074-398-01	COLLIN lateral blade 58X50mm		
074-398-02	80X60mm		
074-398-03	60X80mm		
074-399-13	lateral blade 60X80mm		
074-399-33	62X80mm		
074-450-02	Charnley Retractor Set; Frame round; weight with chain 1530g Valve small; 25X65mm; Valve large 25X50m		
074-452-02	Charnley Valve small 25X65mm		
074-452-08	Charnley Valve large 25X50mm; 25 x 50 mm		
074-452-12	Charnley weight with chain 1530g		
074-452-20	Charnley Frame only; round		
074-460-02	Charnley Retractor Set; Frame square; weight with chain 1737g Valve small; 25X38mm; Valve large 25X44m		

Weitere Artikel
further items
más artículos



Art.Nr.	Beschreibung Description	Size	Spez.
Other items available but not illustrated			
074-462-02	Charnley Valve small 25X38mm		
074-462-04	Charnley Valve small 50x63mm		
074-462-05	Charnley Valve small 50x75mm		
074-462-07	Charnley Valve small 25X75mm		
074-462-08	Charnley Valve large 25X44mm		
074-462-09	Charnley Valve large 25X63mm		
074-462-10	Charnley Valve large 50x63mm		
074-462-12	Charnley weight with chain 1737g		
074-462-13	Charnley Valve large 25X75mm		
074-462-14	Charnley Valve small 101X25mm		
074-462-15	Charnley Valve large 25X101mm		
074-462-16	Charnley Valve small 25X127mm		
074-462-17	Charnley Valve large 25X127mm		
074-462-18	Charnley Valve small 25X25mm		
074-462-19	Charnley Valve large 25X25mm		
074-462-20	Charnley Frame only; square		
074-462-21	Charnley Valve small 25X50mm		
074-462-22	Charnley Valve small 25X63mm		
074-462-23	Charnley Valve small 25X57mm		
074-462-24	Charnley Valve large 25X57mm		
074-462-26	Charnley Valve large 25X50mm		
074-462-27	Charnley Valve small 25X114mm		
074-462-28	Charnley Valve large 25X114mm		
074-462-30	Charnley Valve large 50x75mm		
074-462-32	Charnley Valve small 101mm		
074-462-34	Charnley Valve large, 50x101mm		

074

Weitere Artikel
further items
más artículos

Art.Nr.	Beschreibung Description	Size	Spez.
Other items available but not illustrated			
074-760-24	BALFOUR-BABY central blade; 24X20mm		
074-850-03	TURNER-WARWICK abdominal retractor; complete; frame Ø 305mm; with blades		
	TURNER-WARWICK Frame		
074-850-18	Ø 180mm		
074-850-23	Ø 230mm		
074-850-30	Ø 305mm		
074-850-45	455mm X 330mm		
	TURNER-WARWICK Blade		
074-859-01	13mm		
074-859-02	51X38mm		
074-859-03	76X60mm		
074-859-04	89X60mm		
074-859-05	114X60mm		
074-859-06	19X76mm		
074-859-07	38X102mm		
074-859-08	57X89mm		
074-859-09	57X114mm		
074-860-00	DENNIS-BROWNE abdominal retractor; complete with blades		
074-860-01	DENNIS-BROWNE frame only; 255X180mm		
	DENNIS-BROWNE Blade		
074-860-11	40X30mm		
074-860-22	40X40mm		
074-860-23	20X30mm		
074-860-24	20X40mm		
	KIRSCHNER Frame only		
074-880-02	300X320mm		
074-880-03	300X380mm		
074-880-12	KIRSCHNER-BALFOUR, abdominal retractor; valve only, 83x82mm		
074-882-00	KIRSCHNER abdominal retractor complete; with folding frame		
074-882-01	KIRSCHNER folding frame; 255X255mm		
074-890-00	SEMM abdominal retractor complete 1X074-890-01; 2X074-890-14; 1X074-890-14; 1X074-890-15		
074-890-01	SEMM frame only; 275X250mm		
	SEMM Blades		
074-890-11	98X52mm		
074-890-12	105X35mm		
074-890-13	76X98mm		
074-890-14	47X65mm		

Weitere Artikel
further items
más artículos



Art.Nr.	Beschreibung Description	Size	Spez.
Other items available but not illustrated			
074-890-15	50X54mm		
074-896-01	RING Retractor frame, oval toothed; small; 203 x 311 x 4mm		
074-896-02	toothed; medium; 267 x 368 x 4mm		
074-896-03	toothed; large; 267 x 470 x 4mm		
074-896-05	toothed; segmented; small; 216 x 343 x 4mm		
074-896-06	toothed; segmented; medium; 267 x 495 x 4mm		
074-896-07	toothed; segmented; large; 495 x 317 x 4mm		
074-896-10	RING Retractor frame, round toothed; small; Ø 216mm		
074-896-11	toothed; medium; Ø 267mm		
074-896-12	toothed; large; Ø 317mm		
074-896-15	toothed; segmented; small; Ø 216mm		
074-896-16	toothed; segmented; medium; Ø 267mm		
074-896-19	RING Retractor vaginal frame, oval; toothed; oval; 203 x 266 x 4mm		
074-896-20	RING Retractor segment pieces 2 x 102mm		
074-896-21	2 x 152mm		
074-896-22	2 x 203mm		
074-896-25	RING Retractor ratchet; standard; 4mm		
074-896-27	RING Retractor tilt ratchet with mechanism; opening for ring size Ø 5,1mm		
074-896-28	with mechanism; opening for ring size Ø 4,1mm		
074-896-29	RING Retractor post coupling		
074-896-30	RING Retractor table post; clamping device 470/ 285mm		
074-896-32	RING Retractor extension bar; 305mm		
074-896-34	RING Retractor horizontal bar to hold the frame; 406mm		
074-896-36	with flexible arm		
074-896-40	RING Retractor BALFOUR blade 70 x 85mm; 220mm		
074-896-41	70 x 75mm; 220mm		
074-896-44	RING Retractor KELLY blade 63 x 51mm; 180mm		
074-896-45	51 x 51mm; 180mm		
074-896-46	75 x 65mm; 180mm		
074-896-47	76 x 51mm; 180mm		
074-896-48	102 x 51mm; 180mm		

074

Weitere Artikel
further items
más artículos

Art.Nr.	Beschreibung Description	Size	Spez.
Other items available but not illustrated			
	RING Retractor KELLY blade		
074-896-49	127 x 51mm; 180mm		
074-896-50	154 x 51mm; 180mm		
074-896-51	190 x 50mm; 180mm		
074-896-53	RING Retractor HARRINGTON blade; heart shaped; 145 x64mm; 200mm		
	RING Retractor flexible blade		
074-896-54	150 x 38mm; 302mm		
074-896-55	150 x 51mm; 302mm		
074-896-56	150 x 76mm; 302mm		
074-896-57	RING Retractor GELPI hook; 165mm		
	RING Retractor hook blade		
074-896-59	25,4 x 25,4mm		
074-896-60	51,0 x 25,4mm		
074-896-61	102 x 25,4mm		
	RING Retractor DEEVER blade		
074-896-63	89 x 25mm; 215mm		
074-896-64	127 x 25mm; 220mm		
	RING Retractor Vaginal blade		
074-896-66	83 x 25mm; 180mm		
074-896-68	114 x 25mm; 214mm		
	RING Retractor KELLY blade		
074-896-69	38 x 51mm; 180mm		
074-896-70	40 x 25mm; 180mm		
074-896-71	65 x 25mm; 180mm		
074-896-73	122 x 20mm; 180mm		
074-896-74	122 x 25mm; 180mm		
	RING Retractor RICHARDSON blade		
074-896-76	25 x 19mm; 180mm		
074-896-77	51 x 19mm; 180mm		
074-896-78	34 x 25mm; 180mm		
	RING Retractor rectal blade		
074-896-79	75mm; 167mm		
074-896-80	95mm; 167mm		
	RING Retractor SCOVILLE hook blade		
074-896-82	57 x 26mm; 175mm		
074-896-83	78 x 25mm; 175mm		
	RING Retractor MEYERDING hook blade		
074-896-85	62 x 17mm; 180mm		
074-896-86	81 x 25mm; 180mm		
074-896-87	92 x 50mm; 180mm		

Weitere Artikel
further items
más artículos



Art.Nr.	Beschreibung Description	Size	Spez.
---------	----------------------------	------	-------

Other items available but not illustrated

	RING Retractor skin rake retractor		
074-896-88	19 x 17mm; 3 teeth; 188mm		
074-896-89	8,3 x 19mm; 4 teeth 188mm		
074-896-90	8,3 x 25mm; 6 teeth 188mm		

	RING Retractor KELLY vein blade		
074-896-91	76 x 21mm; 188mm		
074-896-92	102 x 21mm; 180mm		
074-896-93	127 x 21mm; 180mm		
074-896-94	152 x 21mm; 180mm		
074-896-95	178 x 21mm; 180mm		
074-896-96	203 x 21mm; 180mm		

Bauchspatel
Abdominal Spatulas
Espátulas abdominales



Art.Nr.	Beschreibung Description	Size	Spez.
	RIBBON biegsam malleable maleable		
078-170-13	330 x 13 mm		
078-170-25	330 x 25 mm		
078-170-32	330 x 32 mm		
078-170-40	330 x 40 mm		
078-170-50	330 x 50 mm		
	HABERER biegsam malleable maleable		
078-200-01	280 x 25/30 mm		
078-200-02	300 x 37/45 mm		
078-200-03	300 x 40/50 mm		
	RIBBON biegsam malleable maleable		
078-210-06	200 x 6 mm		
078-210-12	200 x 12 mm		
078-210-17	200 x 17 mm		
078-210-20	200 x 20 mm		
078-210-25	200 x 25 mm		
	TUFFIER biegsam malleable maleable		
074-220-20	200 x 17/25 mm		

078

Weitere Artikel
further items
más artículos

Art.Nr.	Beschreibung Description	Size	Spez.
Other items available but not illustrated			
RIBBON abdominal spatulas			
078-170-19	19mm; flexible	33,0cm; 13,2"	
078-170-30	30mm; flexible	33,0cm; 13,2"	
078-170-35	35mm; flexible	33,0cm; 13,2"	
078-170-45	45mm; flexible	33,0cm; 13,2"	
078-170-75	75mm; flexible	33,0cm; 13,2"	
078-210-09	9mm; flexible	20,0cm; 8"	
078-230-28	REVERDIN abdominal spatulas; 45/60mm; flexible	28,0cm; 8"	



Alphabetisches Verzeichnis

A	
ADSON, Wundspreizer	070.9, 070.10, 070.14- 070.16, 070.18
ALM, Wundspreizer	070.3
ANDERSON-ADSON, Wundspreizer	070.8
B	
BALFOUR US-TYPE, Bauchdeckenhalter	074.10
BALFOUR, Bauchdeckenhalter	074.8, 074.9
BALFOUR, Mittelvalve	074.10, 074.11
BALFOUR, Seitenvvalve	074.9, 074.10
BALFOUR-BABY, Bauchdeckenhalter	074.7
Bauchdeckenhaken, ROCHARD	074.15, 074.16
Bauchdeckenhalter, BALFOUR	074.8, 074.9
Bauchdeckenhalter, BALFOUR US-TYPE	074.10
Bauchdeckenhalter, BALFOUR-BABY	074.7
Bauchdeckenhalter, COLLIN	074.3, 074.5
Bauchdeckenhalter, COLLIN-BABY	074.2, 074.4
Bauchdeckenhalter, DOYEN	074.13, 074.14
Bauchdeckenhalter, GOSSET	074.6, 074.7
Bauchdeckenhalter, KIRSCHNER	074.11, 074.14
Bauchdeckenhalter, O'SULLIVAN-O'CONNOR	074.10
Bauchdeckenhalter, RICARD	074.2
Bauchspatel, HABERER	078.1
Bauchspatel, RIBBON	078.1
Bauchspatel, TUFFIER	078.1
BECKMANN, Wundspreizer	070.18
BECKMANN-ADSON, Wundspreizer	070.19, 070.20
BECKMANN-EATON, Wundspreizer	070.17
Befestigungsgestell, ROCHARD	074.14, 074.16
C	
COLLIN, Bauchdeckenhalter	074.3, 074.5
COLLIN, Mittelvalve	074.3, 074.4
COLLIN, Seitenvvalve	074.4- 074.6
COLLIN-BABY, Bauchdeckenhalter	074.2, 074.4
COLLIN-BABY, Seitenvvalve	074.3, 074.4
D	
DE BAKEY, Wundspreizer	070.21
DOYEN, Bauchdeckenhalter	074.13, 074.14
F	
FINSEN, Wundspreizer	070.2
Fixiervorrichtung	074.15
G	
GELPI, Wundspreizer	070.21
GELPI-LOKTITE, Wundspreizer	070.21
GOSSET, Bauchdeckenhalter	074.6, 074.7
H	
HABERER, Bauchspatel	078.1
Haken, Bauchdecken-, ROCHARD	074.15, 074.16
Halter, Bauchdecken-, BALFOUR	074.8, 074.9
Halter, Bauchdecken-, BALFOUR US-TYPE	074.10
Halter, Bauchdecken-, BALFOUR-BABY	074.7
Halter, Bauchdecken-, COLLIN-BABY	074.2, 074.4
Halter, Bauchdecken-, DOYEN	074.13, 074.14
Halter, Bauchdecken-, GOSSET	074.6, 074.7
Halter, Bauchdecken-, KIRSCHNER	074.11, 074.14
Halter, Bauchdecken-, O'SULLIVAN-O'CONNOR	074.10
Halter, Bauchdecken-, RICARD	074.2
Halter, Bauchdecken-, COLLIN	074.3, 074.5
HENLEY, Mittelvalve	070.22
HENLEY, Sperrer	070.22
HENLEY, Wundspreizer	070.22
J	
JANSEN, Wundspreizer	070.2
K	
Kette mit Gewicht	074.14
KIRSCHNER, Bauchdeckenhalter	074.11, 074.14
KIRSCHNER, Rahmen	074.12, 074.13
KIRSCHNER, Valve	074.12- 074.14
M	
MAYO-ADAMS, Wundspreizer	070.12
MEYERDING, Wundspreizer	070.13
MILLIGAN, Wundspreizer	070.8
Mittelvalve, BALFOUR	074.10, 074.11
Mittelvalve, COLLIN	074.3, 074.4
Mittelvalve, HENLEY	070.22
Mittelvalve, RICARD	074.2
MOLLISON, Wundspreizer	070.5
O	
O'SULLIVAN-O'CONNOR, Bauchdeckenhalter	074.10
O'SULLIVAN-O'CONNOR, Rahmen	074.11
O'SULLIVAN-O'CONNOR, Valve	074.11
P	
PLESTER, Wundspreizer	070.11
R	
Rahmen, KIRSCHNER	074.12, 074.13
Rahmen, O'SULLIVAN-O'CONNOR	074.11
RIBBON, Bauchspatel	078.1
RICARD, Bauchdeckenhalter	074.2
RICARD, Mittelvalve	074.2
ROCHARD, Bauchdeckenhaken	074.15, 074.16
ROCHARD, Befestigungsgestell	074.14, 074.16
S	
SCALP-CONTOUR, Wundspreizer	070.4
Seitenvvalve	074.2, 074.6
Seitenvvalve, BALFOUR	074.9, 074.9
Seitenvvalve, COLLIN	074.4- 074.6
Seitenvvalve, COLLIN-BABY	074.3, 074.4
Sperrer, HENLEY	070.22
Spreizer, Wund-, ADSON 070.9, 070.10, 070.14- 070.16, 070.18	
Spreizer, Wund-, ALM	070.3

Alphabetisches Verzeichnis

Spreizer, Wund-, ANDERSON-ADSON	070.8	Wundspreizer, WULLSTEIN.....	070.7
Spreizer, Wund-, BECKMANN.....	070.18		
Spreizer, Wund-, BECKMANN-ADSON.....	070.19, 070.20		
Spreizer, Wund-, DE BAKEY	070.21		
Spreizer, Wund-, FINSSEN	070.2		
Spreizer, Wund-, GELPI.....	070.21		
Spreizer, Wund-, GELPI-LOKTITE.....	070.21		
Spreizer, Wund-, HENLEY	070.22		
Spreizer, Wund-, JANSEN	070.2		
Spreizer, Wund-, MAYO-ADAMS.....	070.12		
Spreizer, Wund-, MEYERDING.....	070.13		
Spreizer, Wund-, MILLIGAN	070.8		
Spreizer, Wund-, MOLLISON	070.5		
Spreizer, Wund-, PLESTER	070.11		
Spreizer, Wund-, SCALP-CONTOUR.....	070.4		
Spreizer, Wund-, WEITLANER.....	070.5, 070.6		
Spreizer, Wund-, WEITLANER-BABY.....	070.12		
Spreizer, Wund-, WEITLANER-LOKTITE.....	070.4		
Spreizer, Wund-, WULLSTEIN	070.7		

T

TUFFIER, Bauchspatel	078.1
----------------------------	-------

V

Valve, KIRSCHNER.....	074.12- 074.14
Valve, Mittel-, BALFOUR	074.10, 074.11
Valve, Mittel-, HENLEY	070.22
Valve, O'SULLIVAN-O'CONNOR.....	074.11
Valve, Seiten.....	074.2, 074.6

W

WEITLANER, Wundspreizer	070.5, 070.6
WEITLANER-BABY, Wundspreizer	070.12
WEITLANER-LOKTITE, Wundspreizer.....	070.4
WULLSTEIN, Wundspreizer	070.7
Wundspreizer, ADSON	070.9, 070.10, 070.14- 070.16, 070.18
Wundspreizer, ALM	070.3
Wundspreizer, ANDERSON-ADSON	070.8
Wundspreizer, BECKMANN.....	070.18
Wundspreizer, BECKMANN-ADSON.....	070.19, 070.20
Wundspreizer, BECKMANN-EATON.....	070.17
Wundspreizer, DE BAKEY	070.21
Wundspreizer, FINSSEN	070.2
Wundspreizer, GELPI.....	070.21
Wundspreizer, GELPI-LOKTITE.....	070.21
Wundspreizer, HENLEY	070.22
Wundspreizer, JANSEN	070.2
Wundspreizer, MAYO-ADAMS.....	070.12
Wundspreizer, MEYERDING.....	070.13
Wundspreizer, MILLIGAN	070.8
Wundspreizer, MOLLISON	070.5
Wundspreizer, PLESTER	070.11
Wundspreizer, SCALP-CONTOUR.....	070.4
Wundspreizer, WEITLANER.....	070.5, 070.6
Wundspreizer, WEITLANER-BABY.....	070.12
Wundspreizer, WEITLANER-LOKTITE.....	070.4



Index, alphabetical

- A**
- abdominal retractor, BALFOUR.....074.8, 074.9
 - abdominal retractor, BALFOUR US-TYPE074.10
 - abdominal retractor, BALFOUR-BABY074.7
 - abdominal retractor, COLLIN074.3, 074.5
 - abdominal retractor, COLLIN-BABY.....074.2, 074.4
 - abdominal retractor, DOYEN.....074.13, 074.14
 - abdominal retractor, GOSSET074.6, 074.7
 - abdominal retractor, KIRSCHNER.....074.11, 074.14
 - abdominal retractor, O'SULLIVAN-O'CONNOR.....074.10
 - abdominal retractor, RICARD074.2
 - abdominal retractor, ROCHARD.....074.15, 074.16
 - abdominal spatulas, HABERER078.1
 - abdominal spatulas, RIBBON.....078.1
 - abdominal spatulas, TUFFIER.....078.1
 - ADSON, self-retaining retractor... 070.9, 070.10, 070.14- 070.16,070.18
 - ALM, self-retaining retractor.....070.3
 - ANDERSON-ADSON, self-retaining retractor070.8
- B**
- BALFOUR US-TYPE, abdominal retractor074.10
 - BALFOUR, abdominal retractor074.8, 074.9
 - BALFOUR, central valve.....074.10, 074.11
 - BALFOUR, lateral valve.....074.9, 074.10
 - BALFOUR-BABY, abdominal retractor074.7
 - BECKMANN, self-retaining retractor.....070.18
 - BECKMANN-ADSON, self-retaining retractor.....070.19, 070.20
 - BECKMANN-EATON, self-retaining retractor.....070.17
- C**
- central valve, BALFOUR.....074.10, 074.11
 - central valve, COLLIN074.3, 074.4
 - central valve, HENLEY070.22
 - central valve, RICARD074.2
 - chain with weight.....074.14
 - COLLIN, abdominal retractor074.3, 074.5
 - COLLIN, central valve074.3- 074.6
 - COLLIN-BABY, abdominal retractor.....074.2, 074.4
 - COLLIN-BABY, lateral valve074.3, 074.4
- D**
- DE BAKEY, self-retaining retractor070.21
 - DOYEN, abdominal retractor.....074.13, 074.14
- F**
- FINSEN, self-retaining retractor070.2
 - fixation device074.15
 - frame, KIRSCHNER.....074.12, 074.13
 - frame, O'SULLIVAN-O'CONNOR.....074.11
- G**
- GELPI, self-retaining retractor070.21
 - GELPI-LOKTITE, self-retaining retractor070.21
 - GOSSET, abdominal retractor074.6, 074.7
- H**
- HABERER, abdominal spatulas078.1
 - HENLEY, central valve.....070.22
 - HENLEY, self-retaining retractor.....070.22
 - HENLEY, spreader070.22
- J**
- JANSEN, self-retaining retractor070.2
- K**
- KIRSCHNER, abdominal retractor074.11, 074.14
 - KIRSCHNER, frame.....074.12, 074.13
 - KIRSCHNER, valve.....074.12- 074.14
- L**
- lateral valve.....074.2, 074.6
 - lateral valve, BALFOUR.....074.9, 074.10
 - lateral valve, COLLIN074.4- 074.6
 - lateral valve, COLLIN-BABY074.3, 074.4
- M**
- MAYO-ADAMS, self-retaining retractor.....070.12
 - MEYERDING, self-retaining retractor070.13
 - MILLIGAN, self-retaining retractor070.8
 - MOLLISON, self-retaining retractor.....070.5
 - mounting frame, ROCHARD074.14, 074.16
- O**
- O'SULLIVAN-O'CONNOR, abdominal retractor.....074.10
 - O'SULLIVAN-O'CONNOR, frame.....074.11
 - O'SULLIVAN-O'CONNOR, valve.....074.11
- P**
- PLESTER, self-retaining retractor.....070.11
- R**
- retractor, abdominal, BALFOUR.....074.8, 074.9
 - retractor, abdominal, BALFOUR US-TYPE074.10
 - retractor, abdominal, BALFOUR-BABY074.7
 - retractor, abdominal, COLLIN074.3, 074.5
 - retractor, abdominal, COLLIN-BABY.....074.2, 074.4
 - retractor, abdominal, DOYEN074.13, 074.14
 - retractor, abdominal, GOSSET074.6, 074.7
 - retractor, abdominal, KIRSCHNER.....074.11, 074.14
 - retractor, abdominal, O'SULLIVAN-O'CONNOR.....074.10
 - retractor, abdominal, RICARD074.2
 - retractor, abdominal, ROCHARD.....074.15, 074.16
 - retractor, self-retaining, ADSON.. 070.9, 070.10, 070.14- 070.16,070.18
 - retractor, self-retaining, ALM070.3
 - retractor, self-retaining, ANDERSON-ADSON.....070.8
 - retractor, self-retaining, BECKMANN070.18
 - retractor, self-retaining, BECKMANN-ADSON070.19, 070.20
 - retractor, self-retaining, BECKMANN-EATON070.17
 - retractor, self-retaining, DE BAKEY070.21
 - retractor, self-retaining, FINSEN.....070.2

Index, alphabetical

retractor, self-retaining, GELPI	070.21
retractor, self-retaining, GELPI-LOKTITE	070.21
retractor, self-retaining, HENLEY.....	070.22
retractor, self-retaining, JANSEN.....	070.2
retractor, self-retaining, MAYO-ADAMS	070.12
retractor, self-retaining, MEYERDING	070.13
retractor, self-retaining, MILLIGAN.....	070.8
retractor, self-retaining, MOLLISON	070.5
retractor, self-retaining, PLESTER.....	070.11
retractor, self-retaining, SCALP-CONTOUR.....	070.4
retractor, self-retaining, WEITLANER	070.5, 070.6
retractor, self-retaining, WEITLANER-BABY	070.12
retractor, self-retaining, WEITLANER-LOKTITE.....	070.4
retractor, self-retaining, WULLSTEIN	070.7
RIBBON, abdominal spatulas.....	078.1
RICARD, abdominal retractor.....	074.2
RICARD, central valve	074.2
ROCHARD, abdominal retractor	074.15, 074.16
ROCHARD, mounting frame	074.14, 074.16

S

SCALP-CONTOUR, self-retaining retractor	070.4
self-retaining retractor, ADSON... 070.9, 070.10, 070.14- 070.16,	070.18
self-retaining retractor, ALM	070.3
self-retaining retractor, ANDERSON-ADSON.....	070.8
self-retaining retractor, BECKMANN	070.18
self-retaining retractor, BECKMANN-ADSON	070.19, 070.20
self-retaining retractor, BECKMANN-EATON	070.17
self-retaining retractor, DE BAKEY	070.21
self-retaining retractor, FINSEN.....	070.2
self-retaining retractor, GELPI	070.21
self-retaining retractor, GELPI-LOKTITE	070.21
self-retaining retractor, HENLEY.....	070.22
self-retaining retractor, JANSEN.....	070.2
self-retaining retractor, MAYO-ADAMS	070.12
self-retaining retractor, MEYERDING	070.13
self-retaining retractor, MILLIGAN.....	070.8
self-retaining retractor, MOLLISON	070.5
self-retaining retractor, PLESTER.....	070.11
self-retaining retractor, SCALP-CONTOUR.....	070.4
self-retaining retractor, WEITLANER	070.5, 070.6
self-retaining retractor, WEITLANER-BABY	070.12
self-retaining retractor, WEITLANER-LOKTITE.....	070.4
self-retaining retractor, WULLSTEIN	070.7
spreader, HENLEY	070.22

T

TUFFIER, abdominal spatulas.....	078.1
----------------------------------	-------

V

valve, central, BALFOUR.....	074.10, 074.11
valve, central, HENLEY	070.22
valve, KIRSCHNER.....	074.12- 074.14
valve, lateral.....	074.2, 074.6
valve, O'SULLIVAN-O'CONNOR.....	074.11

W

WEITLANER, self-retaining retractor	070.5, 070.6
WEITLANER-BABY, self-retaining retractor	070.12
WEITLANER-LOKTITE, self-retaining retractor	070.4
WULLSTEIN, self-retaining retractor	070.7



Indice, alfabético

- A**
ADSON, separadores autoestáticos070.9, 070.10,
..... 070.14- 070.16, 070.18
ALM, separadores autoestáticos070.3
ANDERSON-ADSON, separadores autoestáticos070.8
- B**
BALFOUR US-TYPE, separadores abdominales074.10
BALFOUR, separadores abdominales074.8, 074.9
BALFOUR, valvas centrales074.10, 074.11
BALFOUR, valvas laterales074.9, 074.10
BALFOUR-BABY, separadores abdominales074.7
BECKMANN, separadores autoestáticos070.18
BECKMANN-ADSON, separadores autoestáticos .070.19, 070.20
BECKMANN-EATON, separadores autoestáticos070.17
- C**
cadena con pesa074.14
COLLIN, separadores abdominales074.3, 074.5
COLLIN, valvas centrales074.3, 074.4
COLLIN, valvas laterales 074.4- 074.6
COLLIN-BABY, separadores abdominales074.2, 074.4
COLLIN-BABY, valvas laterales074.3, 074.4
cuadro di supporto, ROCHARD074.14, 074.16
cuadro, KIRSCHNER074.12, 074.13
cuadro, O'SULLIVAN-O'CONNOR074.11
- D**
DE BAKEY, separadores autoestáticos070.21
dispositivo de fijación074.15
DOYEN, separadores abdominales074.13, 074.14
- E**
espátulas abdominales, HABERER078.1
espátulas abdominales, RIBBON078.1
espátulas abdominales, TUFFIER078.1
- F**
FINSEN, separadores autoestáticos070.2
- G**
GELPI, separadores autoestáticos070.21
GELPI-LOKTITE, separadores autoestáticos070.21
GOSSET, separadores abdominales074.6, 074.7
- H**
HABERER, espátulas abdominales078.1
HENLEY, separadores autoestáticos070.22
HENLEY, valvas centrales070.22
- J**
JANSEN, separadores autoestáticos070.2
- K**
KIRSCHNER, cuadro074.12, 074.13
KIRSCHNER, separadores abdominales074.11, 074.14
- KIRSCHNER, valvas 074.12- 074.14
- M**
MAYO-ADAMS, separadores autoestáticos070.12
MEYERDING, separadores autoestáticos070.13
MILLIGAN, separadores autoestáticos070.8
MOLLISON, separadores autoestáticos070.5
- O**
O'SULLIVAN-O'CONNOR, cuadro074.11
O'SULLIVAN-O'CONNOR, separadores abdominales074.10
O'SULLIVAN-O'CONNOR, valvas074.11
- P**
PLESTER, separadores autoestáticos070.11
- R**
RIBBON, espátulas abdominales078.1
RICARD, separadores abdominales074.2
RICARD, valvas centrales074.2
ROCHARD, cuadro di supporto074.14, 074.16
ROCHARD, separadores abdominales074.15, 074.16
- S**
SCALP-CONTOUR, separadores autoestáticos070.4
separadores abdominales, BALFOUR074.8, 074.9
separadores abdominales, BALFOUR US-TYPE074.10
separadores abdominales, BALFOUR-BABY074.7
separadores abdominales, COLLIN074.3, 074.5
separadores abdominales, COLLIN-BABY074.2, 074.4
separadores abdominales, DOYEN074.13, 074.14
separadores abdominales, GOSSET074.6, 074.7
separadores abdominales, KIRSCHNER074.11, 074.14
separadores abdominales, O'SULLIVAN-O'CONNOR074.10
separadores abdominales, RICARD074.2
separadores abdominales, ROCHARD074.15, 074.16
separadores autoestáticos, ADSON070.9, 070.10,
..... 070.14- 070.16, 070.18
separadores autoestáticos, ALM070.3
separadores autoestáticos, ANDERSON-ADSON070.8
separadores autoestáticos, BECKMANN070.18
separadores autoestáticos, BECKMANN-ADSON .070.19, 070.20
separadores autoestáticos, BECKMANN-EATON070.17
separadores autoestáticos, DE BAKEY070.21
separadores autoestáticos, FINSEN070.2
separadores autoestáticos, GELPI070.21
separadores autoestáticos, GELPI-LOKTITE070.21
separadores autoestáticos, HENLEY070.22
separadores autoestáticos, JANSEN070.2
separadores autoestáticos, MAYO-ADAMS070.12
separadores autoestáticos, MEYERDING070.13
separadores autoestáticos, MILLIGAN070.8
separadores autoestáticos, MOLLISON070.5
separadores autoestáticos, PLESTER070.11
separadores autoestáticos, SCALP-CONTOUR070.4
separadores autoestáticos, WEITLANER070.5, 070.6

Indice, alfabético

separadores autoestáticos, WEITLANER-BABY	070.12
separadores autoestáticos, WEITLANER-LOKTITE	070.4
separadores autoestáticos, WULLSTEIN	070.7

T

TUFFIER, espátulas abdominales	078.1
--------------------------------------	-------

V

valvas centrales, BALFOUR	074.10, 074.11
valvas centrales, COLLIN	074.3, 074.4
valvas centrales, HENLEY	070.22
valvas centrales, RICARD	074.2
valvas laterales	074.2, 074.6
valvas laterales, BALFOUR	074.9, 074.10
valvas laterales, COLLIN	074.4- 074.6
valvas laterales, COLLIN-BABY	074.3, 074.4
valvas, KIRSCHNER	074.12- 074.14
valvas, O'SULLIVAN-O'CONNOR	074.11

W

WEITLANER, separadores autoestáticos	070.5, 070.6
WEITLANER-BABY, separadores autoestáticos	070.12
WEITLANER-LOKTITE, separadores autoestáticos	070.4
WULLSTEIN, separadores autoestáticos	070.7