

cup jaw

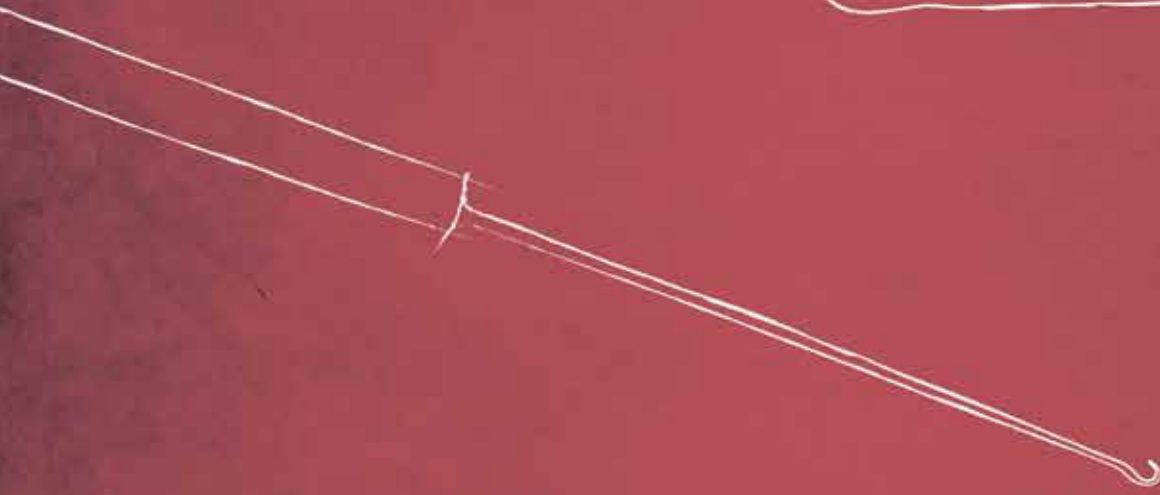

sharp

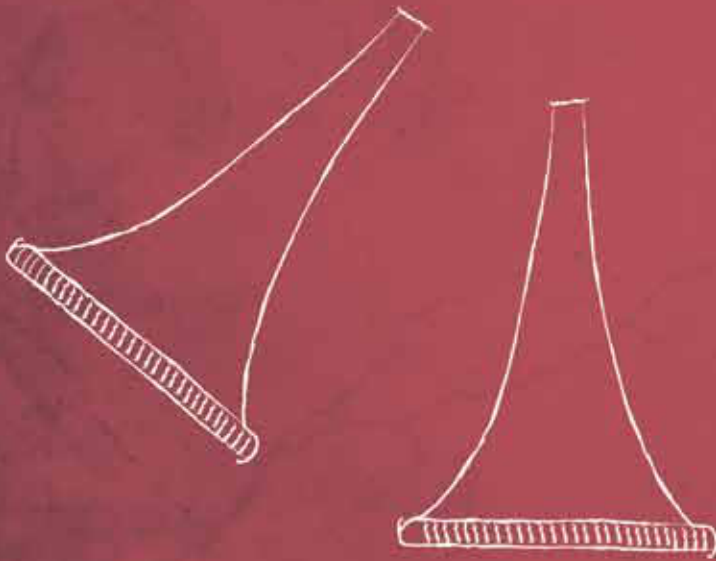

Otologie
Otology



Ohrspekula
 Ear specula
 Espéculos auriculares



Art.Nr. Beschreibung | Description Size Spez.

HARTMANN



111-020-03	Satz mit Figur 0-2 für Kinder Set with fig. 0-2 for children juego con fig. 0-2 para niños	111-021-00	Fig. 0	2,0 mm	⊙
		111-021-01	Fig. 1	3,5 mm	①
		111-021-02	Fig. 2	5,0 mm	②
111-030-03	Satz mit Figur 2-4 für Erwachsene Set with fig. 2-4 for adults juego con fig. 2-4 para adultos	111-021-03	Fig. 3	6,5 mm	③
		111-021-04	Fig. 4	7,5 mm	④
111-030-04	Satz mit Figur 1-4 für Erwachsene Set with fig. 1-4 for adults juego con fig. 1-4 para adultos				

TOYNBEE



111-034-03	Satz mit Figur 2-4 für Erwachsene Set with fig. 2-4 for adults juego con fig. 2-4 para adultos	111-035-01	Fig. 1	3,0 mm	①
		111-035-02	Fig. 2	4,0 mm	②
111-034-04	Satz mit Figur 1-4 für Erwachsene Set with fig. 1-4 for adults juego con fig. 1-4 para adultos	111-035-03	Fig. 3	5,0 mm	③
		111-035-04	Fig. 4	6,5 mm	④

Ohrspekula
 Ear specula
 Espéculos auriculares

Art.Nr.	Beschreibung Description		Size	Spez.	
	ZÖLLNER ALUMINIUM				
					
111-044-00	Satz mit Figur 1-6 Set with fig. 1-6 juego con fig. 1-6	111-044-01	Fig. 1	5,5 x 6,5 mm	1
		111-044-02	Fig. 2	6,5 x 7,5 mm	2
		111-044-03	Fig. 3	7,5 x 8,5 mm	3
		111-044-04	Fig. 4	8,5 x 9,5 mm	4
		111-044-05	Fig. 5	9,5 x 10,5 mm	5
		111-044-06	Fig. 6	10,5 x 11,5 mm	6

111-070-12 Metallständer für 12 Spekulas
 storage rack for 12 ear specula
 Soporte para 12 espejos auriculares

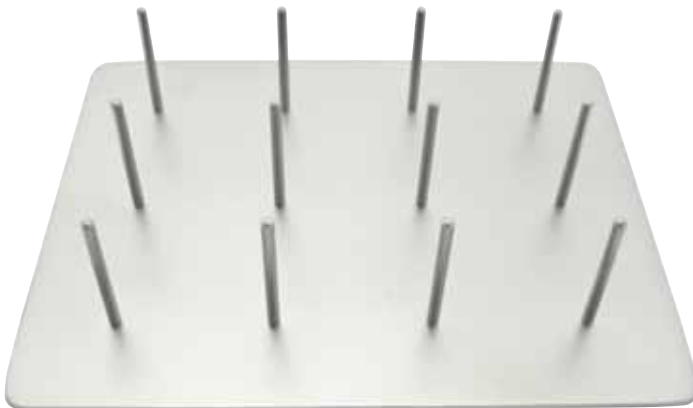

Polypenschnürer
 polypus snares
 polipótomos



Art.Nr.	Beschreibung Description	Size	Spez.
111-100-00	KRAUSE offenes Ende open tip punta abierta	16,0cm; 6 2/8"	



111-110-00	KRAUSE-VOSS geschlossenes Ende closed tip punta cerrada	16,0cm; 6 2/8"	
------------	--	----------------	--









Schnürdraht
 Snare wire
 alambre

111-128-03 0,3 mm

111-128-04 0,4 mm

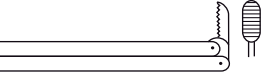

Ohrpolypenzangen
 Ear forceps
 Pinzas auriculares

Art.Nr.	Beschreibung Description	Size	Spez.
111-210-00	HARTMANN feines Modell delicate pattern modelo delicado	12,0cm; 4 6/8"	
			
111-210-01	HARTMANN normales Modell regular model modelo regular	14,0cm; 5 4/8"	
			
111-215-00	BUCK Fremdkörperheber foreign body lever elevador para cuerpos extraños	11,5cm; 4 4/8"	
			
111-217-00	QUIRE Fremdkörperheber foreign body lever elevador para cuerpos extraños	10,5cm; 4 1/8"	
			

Ohrpolypenzangen
 Ear forceps
 Pinzas auriculares



Art.Nr.	Beschreibung Description	Size	Spez.
---------	----------------------------	------	-------



111-250-08	HARTMANN-WULLSTEIN	85 mm	
------------	--------------------	-------	--



111-252-08	HARTMANN-WULLSTEIN	85 mm	
------------	--------------------	-------	--



HARTMANN

111-256-08		85 mm	
------------	--	-------	--



111-256-14		140 mm	
------------	--	--------	--

111-258-08	HARTMANN	85 mm	
------------	----------	-------	--



1
1
1

Ohrpolypenzangen
 Ear forceps
 Pinzas auriculares

Art.Nr.	Beschreibung Description	Size	Spez.
---------	----------------------------	------	-------



HARTMANN

85 mm

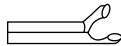

111-268-20 Ø 2,0 mm ○

111-268-25 Ø 2,5 mm ○ 

111-268-30 Ø 3,0 mm ○

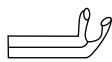
111-280-30 Ø 3,0 mm ○ 

111-292-08 STRUEMPEL

85 mm



111-298-20 HARTMANN-HOFFMANN

85 mm

durchschneidend | trough-cutting | cortante

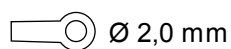

Mikro-Ohrzängchen
 Micro Ear Forceps
 Micro pinzas auriculares



Art.Nr.	Beschreibung Description	Size	Spez.
	MINI MCGEE	80 mm	



111-302-08 glatt, gerade | smooth, straight | lisa, recta

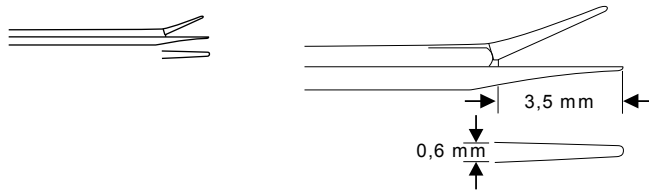

111-304-08 gerieft, gerade | serrated, straight | estriada, recta

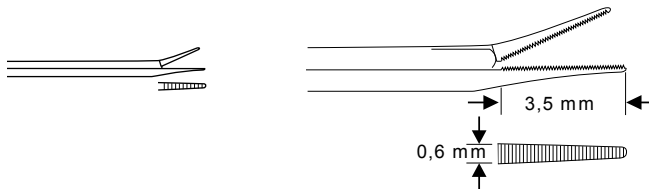

Mikro-Ohrzängchen
 Micro Ear Forceps
 Micro pinzas auriculares

Art.Nr. Beschreibung | Description Size Spez.

80 mm



111-314-08 glatt, gerade | smooth, straight | lisa, recta

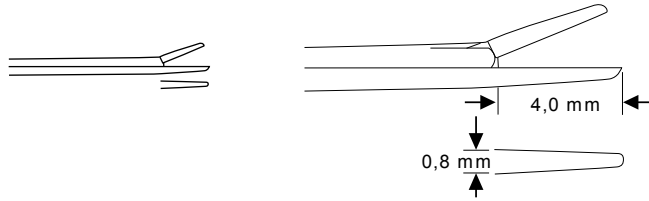

111-310-08 gerieft, gerade | serrated, straight | estriada, recta

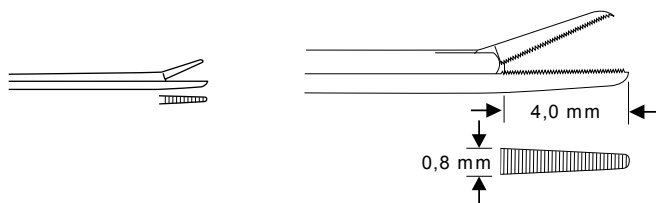

111-318-08 links, gerieft | left, serrated | izquierda, estriada

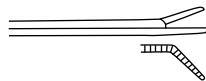

111-322-08 rechts, gerieft | right, serrated | derecha, estriada

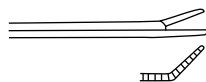

111-326-08 aufgebogen, gerieft | bent upwards, serrated
 curva hacia arriba, estriada

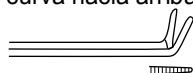

Mikro-Ohrzängchen
 Micro Ear Forceps
 Micro pinzas auriculares



Art.Nr.	Beschreibung Description	Size	Spez.
---------	----------------------------	------	-------

80 mm



111-310-06 gerieft, gerade | serrated, straight | estriada, recta

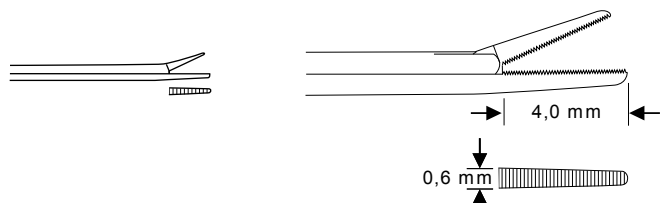

111-326-06 aufgebogen, gerieft | bent upwards, serrated
 curva hacia arriba, estriada

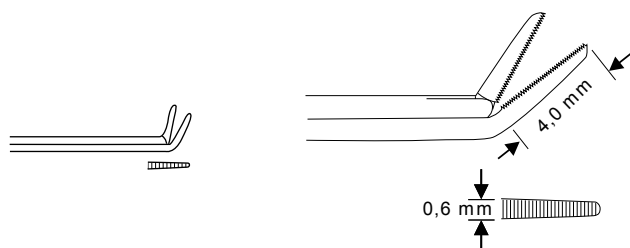

111-322-06 rechts, gerieft | right, serrated | derecha, estriada

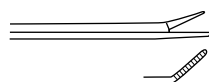

111-318-06 links, gerieft | left, serrated | izquierda, estriada

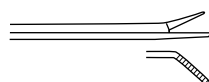

Mikro-Ohrzängchen
Micro Ear Forceps
Micro pinzas auriculares

Art.Nr.	Beschreibung Description	Size	Spez.
---------	----------------------------	------	-------

80 mm



111-340-08 glatt, gerade | smooth, straight | lisa, recta

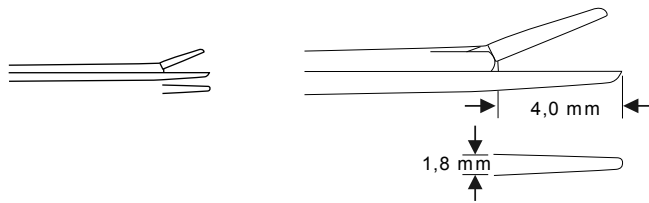

Mikro-Ohrzängchen
 Micro Ear Forceps
 Micro pinzas auriculares



Art.Nr.	Beschreibung Description	Size	Spez.
		80 mm	

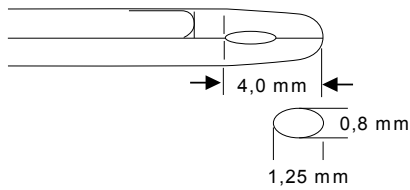

111-344-08 gerade | straight | recta

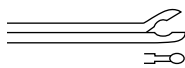

111-348-08 rechts | right | derecha

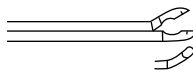

111-352-08 links | left | izquierda



111-356-08 aufgebogen | bent upwards | curva hacia arriba

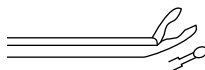

111

Mikro-Ohrzängchen
 Micro Ear Forceps
 Micro pinzas auriculares

Art.Nr.	Beschreibung Description	Size	Spez.
	MINI-MCGEE	80 mm	

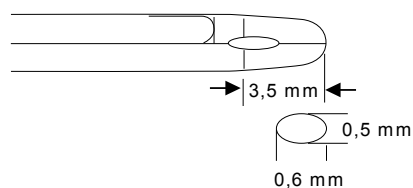

111-344-06 gerade | straight | recta

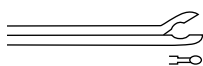

111-356-06 aufgebogen | bent upwards | curva hacia arriba

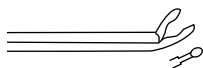

111-348-06 rechts | right | derecha

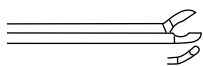

111-352-06 links | left | izquierda

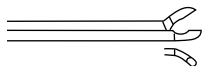

Mikro-Ohrzängchen
 Micro Ear Forceps
 Micro pinzas auriculares



Art.Nr.	Beschreibung Description	Size	Spez.
MCGEE	Drahtbiegezängchen Wire Bending Forceps Pinza para plegar alambre	80 mm	

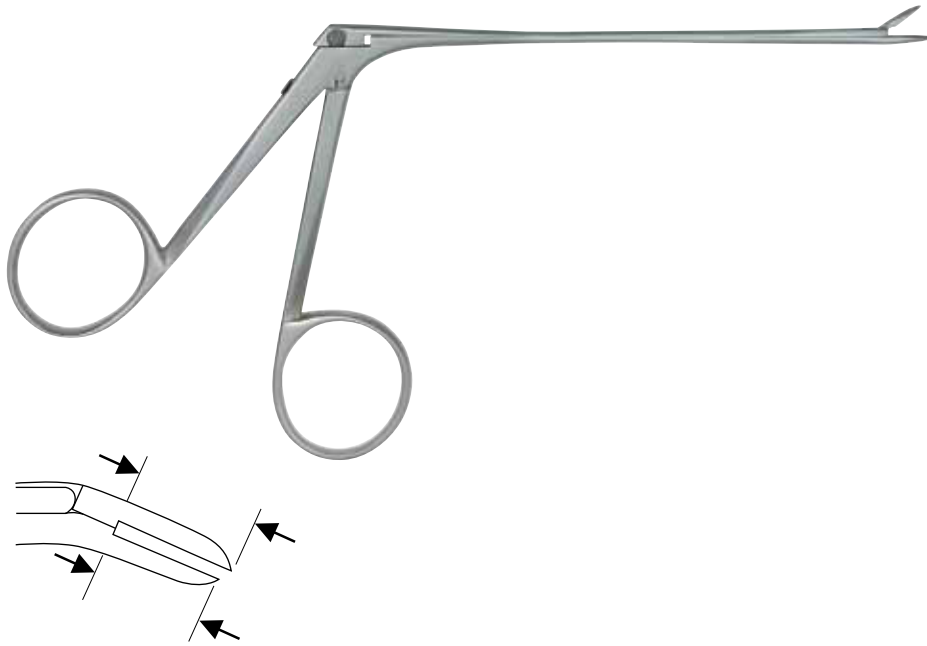

111-366-08 abgebogen
bent downwards | curva hacia abajo



111-368-08 abgebogen
bent downwards | curva hacia abajo



Mikro-Ohrscheren
 Micro Ear Scissors
 Micro tijeras auriculares

Art.Nr.	Beschreibung Description	Size	Spez.
	BELLUCCI sehr fein very fine muy fina	80 mm	

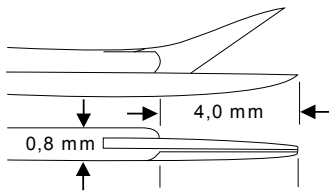

111-372-08 gerade
straight | recta

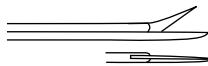

111-374-08 aufgebogen
bent upwards | curva hacia arriba

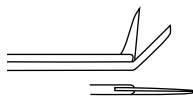

111-376-08 links
left | izquierda

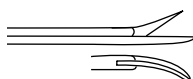

111-380-08 rechts
right | derecha



Mikro-Ohrzängchen
 Micro Ear Forceps
 Micro pinzas auriculares



Art.Nr.	Beschreibung Description	Size	Spez.
DIETER	Hammerkopfzängchen Malleus Nipper Pinza para cabezal del maléolo	90 mm	

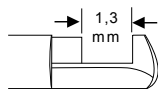

111-386-08 gerade; aufwärts schneidend
 straight; cutting upwards | recta; corte arriba



111-388-08 gerade; abwärts schneidend
 straight; cutting downwards | recta; corte abajo



111-387-08 gerade; rechts schneidend
 straight; right cutting | recta; corte derecho



111-389-08 gerade; links schneidend
 straight; left cutting | recta; corte izquierdo

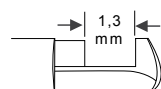

Ohr- Knochenstanzen
mastoid Rongeurs
pinzas cortantes para huesos

Art.Nr.	Beschreibung Description	Size	Spez.
---------	----------------------------	------	-------

CITELLI

75 mm



111-500-02 2 mm 

111-500-03 3 mm 

BEYER

95 mm



111-502-19 2 mm 

Antrumstanzen
Antrum Punches
Pinza para seno maxilar





Art.Nr.	Beschreibung Description	Size	Spez.
---------	----------------------------	------	-------

KERRISON

8,5cm; 3 3/8"



111-506-03 3 x 3 mm 

111-506-04 4 x 4 mm 

111-506-05 5 x 5 mm 

111-506-06 6 x 6 mm 

Ohrküretten
 Ear Currettes
 Curetas auriculares

Art.Nr.	Beschreibung Description	Size	Spez.
	BUCK	15,0cm; 6 6/8"	

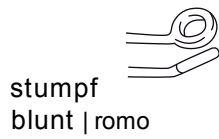

111-510-00	Fig. 000		111-512-02	Fig. 2	
111-511-00	Fig. 00		111-512-03	Fig. 3	
111-512-00	Fig. 0		111-512-04	Fig. 4	
111-512-01	Fig. 1				

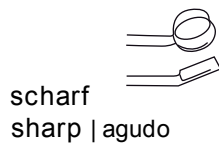

111-520-00	Fig. 000		111-522-02	Fig. 2	
111-521-00	Fig. 00		111-522-03	Fig. 3	
111-522-00	Fig. 0		111-522-04	Fig. 4	
111-522-01	Fig. 1		111-522-05	Fig. 5	

Ohrküretten
 Ear Curettes
 Curetas auriculares



Art.Nr.	Beschreibung Description	Size	Spez.
---------	----------------------------	------	-------

SHAPLEIGH

15,0cm; 5 7/8"



111-526-01

Fig. 1



111-526-02

Fig. 2

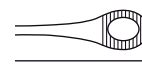

111-528-13

LANGENBECK stumpf
 blunt
 romo

13,0cm; 5 1/8"



111-530-18

BARTH

18,0cm; 7 1/8"



111-532-15

JANSEN

scharf
 sharp
 agudo

16,0cm; 6 2/8"

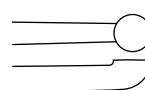
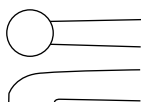

111

Ohröffel; Fremdkörperinstrumente
 Ear Scoop; Foreign Body Instruments
 Cucharilla auricular; Instrumentos para cuerpos extraños

Art.Nr.	Beschreibung Description	Size	Spez.
---------	----------------------------	------	-------

BILLEAU

16,5cm; 6 4/8"



111-540-01

Fig. 1



111-540-03

Fig. 3

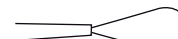

111-540-02

Fig. 2

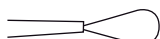

111-546-12

GROSS

13,0cm; 5 1/8"

stumpf | blunt | romo



111-550-16

HARTMANN

Ohrhäkchen
 Ear Hooklet
 Ganchito auricular aguda

16,0cm; 6 2/8"

scharf | sharp | aguda



111-556-16

ZAUFAL

Ohrhebel
 Foreign body lever
 Elevator para cuerpos extraños

16,5cm 6 4/8"



Ohrhäkchen
 Ear hook
 Ganchito auriculare



Art.Nr.	Beschreibung Description	Size	Spez.
---------	----------------------------	------	-------

DAY

17,0cm; 6 6/8"



111-560-01	1,5 mm	
------------	--------	--

111-560-02	2,5 mm	
------------	--------	--

WAGENER

14,0cm; 5 4/8"



111-588-01	4,0 mm	
------------	--------	--

111-588-05	2,0 mm	
------------	--------	--

111-588-02	3,5 mm	
------------	--------	--

111-588-06	1,5 mm	
------------	--------	--

111-588-03	3,0 mm	
------------	--------	--

111-588-07	1,0 mm	
------------	--------	--

111-588-04	2,5 mm	
------------	--------	--

LUCAE

14,0cm; 5 4/8"



111-606-01	Fig. 1	2,0 mm	
------------	--------	--------	--

111-606-02	Fig. 2	3,0 mm	
------------	--------	--------	--

111-606-03	Fig. 3	4,0 mm	
------------	--------	--------	--

Parazentesenadel
 Tympanum needle
 Aguja para tímpano

Art.Nr.	Beschreibung Description	Size	Spez.
111-615-16	POLITZER Nadel horizontal needle horizontally aguja en posición horizontal	16,0cm; 6 2/8"	



111-616-16	POLITZER Nadel vertikal needle vertically aguja en posición vertical	16,0cm; 6 2/8"	
------------	---	----------------	--



111-618-18	LUCAE Nadel vertikal needle vertically aguja en posición vertical	18,0cm; 7 1/8"	
------------	--	----------------	--



111-619-18	LUCAE Nadel horizontal needle horizontally aguja en posición horizontal	18,0cm; 7 1/8"	
------------	--	----------------	--



Mikro-Ohrhäkchen; Mikro-Ohrnadeln
 Micro Ear Hooks; Micro Ear Needles
 Micro ganchitos auriculares; Micro agujas auriculares



Art.Nr.	Beschreibung Description	Size	Spez.
	BARBARA	16,0cm; 6 2/8"	



111-636-06	0,6 mm	25°	
111-636-10	1,0 mm	25°	

	BARBARA	16,0cm; 6 2/8"	
--	---------	----------------	--



111-637-03	0,3 mm	45°	111-638-03	0,3 mm	90°
111-637-06	0,6 mm	45°	111-638-06	0,6 mm	90°
111-637-10	1,0 mm	45°	111-638-10	1,0 mm	90°
111-637-12	1,2 mm	45°	111-638-12	1,2 mm	90°
111-637-15	1,5 mm	45°	111-638-15	1,5 mm	90°
111-637-20	2,0 mm	45°	111-638-20	2,0 mm	90°
111-637-25	2,5 mm	45°	111-638-25	2,5 mm	90°

	BARBARA	16,0cm; 6 2/8"	
--	---------	----------------	--



111-639-06	0,5 mm		
111-639-10	1,0 mm		

		16,0cm; 6 2/8"	
--	--	----------------	--



111-640-00	BARBARA		111-640-01	BARBARA	
111-640-02	BARBARA		111-640-03	ROSEN	

Mikro-Ohrhäkchen; Mikro-Ohrnadeln
 Micro Ear Hooks; Micro Ear Needles
 Micro ganchitos auriculares; Micro agujas auriculares

Art.Nr.	Beschreibung Description	Size	Spez.
---------	----------------------------	------	-------

16,0cm; 6 2/8"



aufgewinkelt
 bent upwards
 angulado hacia arriba

abgewinkelt
 angled
 angulado

111-648-03	0,3 mm	90°	111-649-03	0,3 mm	90°
111-648-06	0,6 mm	90°	111-649-06	0,6 mm	90°
111-648-10	1,0 mm	90°	111-649-10	1,0 mm	90°

MCGEE

16,0cm; 6 2/8"



aufgewinkelt
 bent upwards
 angulado hacia arriba

abgewinkelt
 angled
 angulado

111-652-05	0,5 mm		111-653-05	0,5 mm	
111-652-10	1,0 mm		111-653-10	1,0 mm	

BARBARA

15,5cm; 6 1/8"



111-654-00		111-654-01	
------------	--	------------	--

Mikro-Ohrmesser
 Micro Ear Knives
 Micro cuchillos auriculares



Art.Nr.	Beschreibung Description	Size	Spez.
---------	----------------------------	------	-------

ROSEN

15,0cm; 5 7/8"



111-666-30	Fig. 1 Ø 3,0 mm	
111-666-28	Fig. 2 Ø 2,8 mm	
111-666-26	Fig. 3 Ø 2,6 mm	
111-666-20	Fig. 4 Ø 2,0 mm	
111-666-16	Fig. 5 Ø 1,6 mm	
111-666-14	Fig. 6 Ø 1,4 mm	
111-666-10	Fig. 7 Ø 1,0 mm	

111-671-16	PLESTER	Lappenmesser Flap Knife Cuchillo para lóbulos
------------	---------	---

15,0cm; 5 7/8"
 Ø 3,5 mm



111-672-16	TABB	Schleimhautmesser Mucosa Knife Cuchillo para mucosa
------------	------	---

15,5cm; 6 1/8"



Mikro-Ohrmesser
Micro Ear Knives
Micro cuchillos auriculares

Art.Nr.	Beschreibung Description	Size	Spez.
111-675-16	WULLSTEIN Sichelmesser Sickle Knife Cuchillo de hoz	15,5cm; 6 1/8"	



111-676-16	SCHUKNECHT Sichelmesser Sickle Knife Cuchillo de hoz	14,5cm; 5 6/8"	
------------	---	----------------	--



Mikro-Dissektoren; Mikro-Messsonden
 Micro Dissectors; Micro Measuring Rods
 Micro disecadores; Micro sondas para medir



Art.Nr.	Beschreibung Description	Size	Spez.
	FISCH	15,5cm; 6 1/8"	



111-686-01	Fig. 1		nach rechts abgewinkelt angled to right angulada por derecha
------------	--------	---	---

111-686-02	Fig. 2		nach links abgewinkelt angled to left angulada por izquierda
------------	--------	---	---

111-686-03	Fig. 3		nach rechts abgewinkelt angled to right angulada por derecha
------------	--------	---	---

111-686-04	Fig. 4		nach links abgewinkelt angled to left angulada por izquierda
------------	--------	---	---

	HOUSE	15,5cm; 6 1/8"
--	-------	----------------



111-688-35	3,5 mm	
------------	--------	---

111-688-40	4,0 mm	
------------	--------	---

111-688-45	4,5 mm	
------------	--------	---

111-688-50	5,0 mm	
------------	--------	---



Küretten; Ohrkatheter
 curettes; Ear Catheters
 cucharillas; sondas auriculares

Art.Nr.	Beschreibung Description	Size	Spez.
	HOUSE leicht gebogen slightly curved curva	14,5cm; 5 6/8"	



111-701-01	 1,2 + 1,0 mm	
------------	--	---

111-701-02	 1,8 + 1,5 mm	
------------	--	---

	HOUSE stark gebogen strongly curved curva fuerte	14,5cm; 5 6/8"	
--	--	----------------	--



111-703-01	 1,2 + 1,0 mm	
------------	--	---

111-703-02	 1,8 + 1,5 mm	
------------	--	---

	HARTMANN	15,0cm; 5 7/8"	
--	----------	----------------	--



111-848-01	Fig. 1 
------------	--

111-848-02	Fig. 2 
------------	--

111-848-03	Fig. 3 
------------	--







Stimmgabeln
Tuning Forks
Diapasónes



Art.Nr.	Beschreibung Description	Size	Spez.
111-852-00	HARTMANN C 128		
111-852-01	HARTMANN C ¹ 256		
111-852-02	HARTMANN C ² 512		
111-852-03	HARTMANN C ³ 1024		
111-852-04	HARTMANN C ⁴ 2048		
111-852-05	HARTMANN C ⁵ 4096		

111

Stimmgabeln
Tuning Forks
Diapasónes

Art.Nr.	Beschreibung Description	Size	Spez.
111-853-00	LUCAE C 128		
			
111-853-01	LUCAE C ¹ 256		
			
111-853-02	LUCAE C ² 512		
			
111-853-03	LUCAE C ³ 1024		
			
111-853-04	LUCAE C ⁴ 2048		
			
111-853-05	LUCAE C ⁵ 4096		
			





Stimmgabeln
Tuning Forks
Diapasónes



Art.Nr.	Beschreibung Description	Size	Spez.
111-854-00	HARTMANN/ FRENCH C2 16		
111-854-01	HARTMANN/ FRENCH C1 32		
111-854-02	HARTMANN/ FRENCH C 64		
111-854-03	HARTMANN/ FRENCH C 128		
111-854-04	HARTMANN/ FRENCH C1 256		



Stimmgabeln
Tuning Forks
Diapasónes

Art.Nr.	Beschreibung Description	Size	Spez.
111-856-02	ALUMINIUM C 128		
			
111-856-03	ALUMINIUM C1 256		
			
111-856-04	ALUMINIUM C2 512		
			
111-856-05	ALUMINIUM C3 1024		
			
111-856-06	ALUMINIUM C4 2048		
			

Stimmgabeln
Tuning Forks
Diapasónes



Art.Nr.	Beschreibung Description	Size	Spez.
---------	----------------------------	------	-------

111-860-00	RYDEL-SEIFFER C 64/ C 128	mit Dämpfer und Fuß with damper and socket con sordina y pedestal	
------------	---------------------------	---	--



111-858-10	LUCAE C 128	verschiebbar bis h moveable up to h regulable hasta h	
------------	-------------	---	--

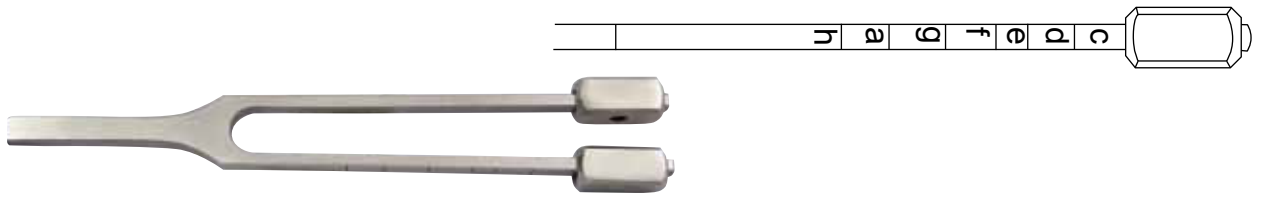

111-858-05	HARTMANN C 128	verschiebbar bis h moveable up to h regulable hasta h	
------------	----------------	---	--

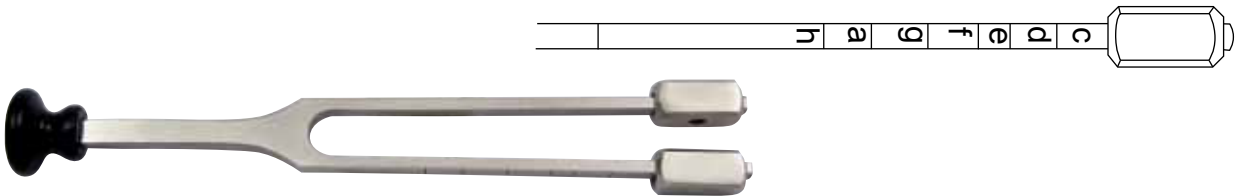

111-899-00	256 Hz	für neurologische Untersuchungen; mit Hammer; Nadelrad; Pinsel und Nadel for neurosurgery with hammer; pinwheel; brush and needle para neurocirugía con martillo; rueda con espinas; cepillo y aguja	
------------	--------	--	--



Luftduschen
Air Bags
Insuf adores de aire

Art.Nr.	Beschreibung Description	Size	Spez.
111-880-00	POLITZER mit 3 Nasenoliven with 3 nasal olives con 3 olivas nasales		SET
111-880-01	POLITZER Gummibirne alleine rubber bulb only pera de goma suelto		
111-880-04	POLITZER Ohrolive ear olive oliva auricular	Ø 4,0 mm	
	POLITZER Nasenolive nose olive oliva nasal		
111-880-15		Ø 15,0 mm	
111-880-17		Ø 17,0 mm	
111-880-22		Ø 22,0 mm	
111-880-30	POLITZER Einsteckkonus connecting nozzle cono de conexión		



Pulverbläser
Atomizers
Pulverizadores



Art.Nr.	Beschreibung Description	Size	Spez.
111-882-00	KABIERSKE mit 3 Kanülen und Gummiball with 3 cannulas and rubber bulb con 3 cánulas y pera de goma		SET



111-882-01	KABIERSKE Ventilball valve rubber bulb pera de goma		
111-882-02	KABIERSKE Ersatzflasche spare bottle frasco suelto	30 ccm	

KABIERSKE Kanüle
cannula
cánula

111-882-08		8,0cm; 3"
111-882-11		11,0cm; 4"
111-882-13		13,0cm; 5"

Ohrspritzen
 Ear Syringes
 Jeringas auriculares

Art.Nr.	Beschreibung Description	Size	Spez.
---------	----------------------------	------	-------

mit Teller und 2 Ansätzen
 with protection disc and 2 tips
 con disco protector y 2 puntas

SET

111-888-05	50 ml		
111-888-10	100 ml		

Spülansatz
 irrigation adapter
 adaptador de irrigación

111-888-01		
------------	---	--

111-888-02		
------------	---	--

111-888-03	Schutzteller protecting disc disco protector	
------------	--	--



Ohrspritzen
Ear Syringes
Jeringas auriculares



Art.Nr.	Beschreibung Description	Size	Spez.
111-881-00	Selbstfüllend komplett in Kunststofftasche self filling in plastic pouch auto-rellena en bolsa plástica		SET
111-888-00	Verbindungsschlauch für Ohrspritze flexible tube for ear syringe tubo de conexión para jeringa auriculare		
111-888-09	Ventilaufsatz für Ohrspritze valva attachment for ear syringe válvula de conexión		
111-888-06	Saugansatz für Ohrspritze suction nozzle for ear syringe pieza de succión		
111-888-07	Metallolive für Ohrspritze metal olive for ear syringe oliva metálica para jeringa auriculare		
111-888-04	Gewindeansatz für Ohrspritze threaded tip for ear syringe punta de rosca para jeringa auriculare		

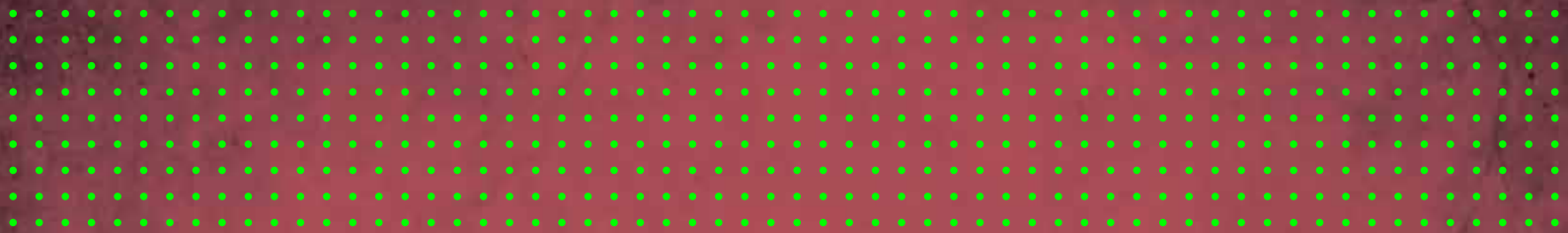

cup jaw

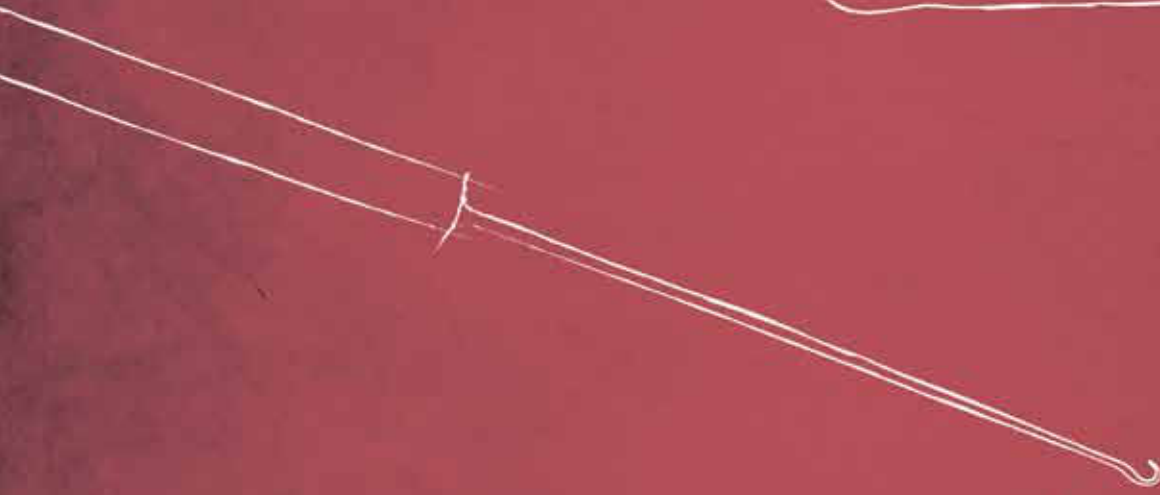

sharp

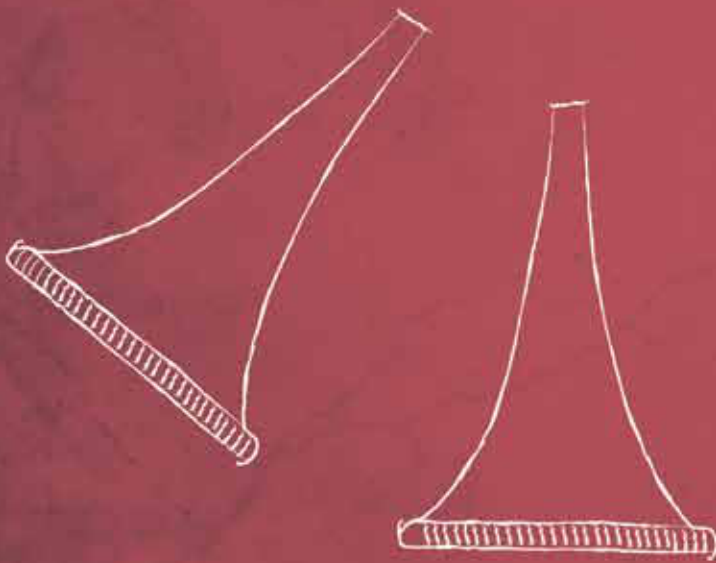

Rhinologie
Rhinology

112





Antrumstanzen
 Antrum Punches
 Pinza para seno maxilar





Art.Nr.	Beschreibung Description	Size	Spez.
	KERRISON	8,5cm; 3 3/8"	



111-506-03 3 x 3 mm 

111-506-04 4 x 4 mm 

111-506-05 5 x 5 mm 

111-506-06 6 x 6 mm 

Nasenspekula
 Nasal specula
 Espéculos nasales

Art.Nr.	Beschreibung Description	Size	Spez.
---------	----------------------------	------	-------

HARTMANN-HALLE

16,0cm; 6 2/8"



112-020-01 Fig. 1 27 mm

112-020-02 Fig. 2 31 mm

112-020-03 Fig. 3 35 mm

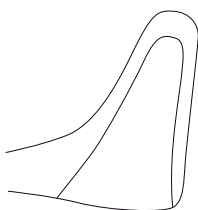

112-030-01 TIECK-HALLE

13,0cm; 5 1/8"
 16 mm



112-033-13 BECKMANN

13,0cm; 5 1/8"
 17 mm

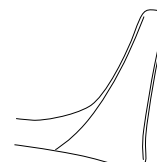

Nasenspekula
 Nasal specula
 Espéculos nasales



Art.Nr.	Beschreibung Description	Size	Spez.
---------	----------------------------	------	-------

KILLIAN



112-040-35

Fig. 1 35 mm
 14,0cm; 5 4/8"

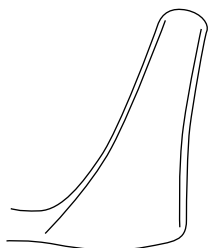

112-040-75

Fig. 3 75 mm
 16,0cm; 6 2/8"

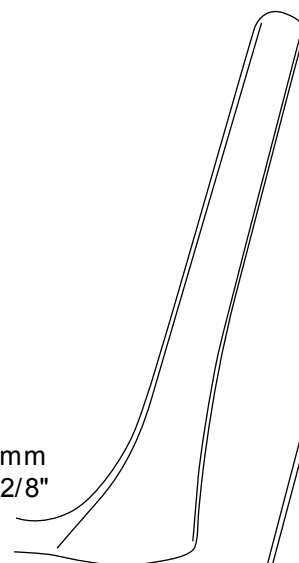

112-040-50

Fig. 2 50 mm
 14,5cm; 5 6/8"

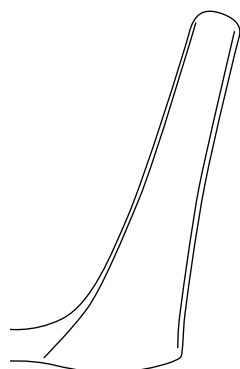

112-040-90

Fig. 4 90 mm
 17,0cm; 6 6/8"

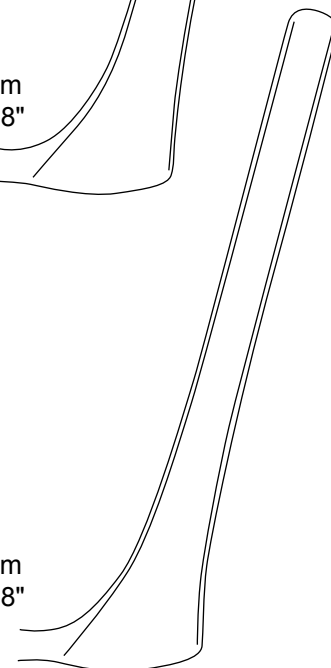

112

Nasenspekula
 Nasal specula
 Espéculos nasales

Art.Nr.	Beschreibung Description	Size	Spez.
	VIENNA (WIEN)	14,0cm; 5 4/8"	



112-050-01 Fig. 1 26 mm

112-050-02 Fig. 2 30 mm

112-050-03 Fig. 3 33 mm

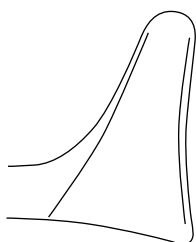

COTTLE

15,0cm; 6"



112-060-01 Fig. 1 35 mm
13,5cm; 5 3/8"

112-060-02 Fig. 2 50 mm
14,0cm; 5 4/8"

112-060-03 Fig. 3 75 mm
16,0cm; 6 2/8"

112-060-04 Fig. 4 90 mm
16,0cm; 6 2/8"

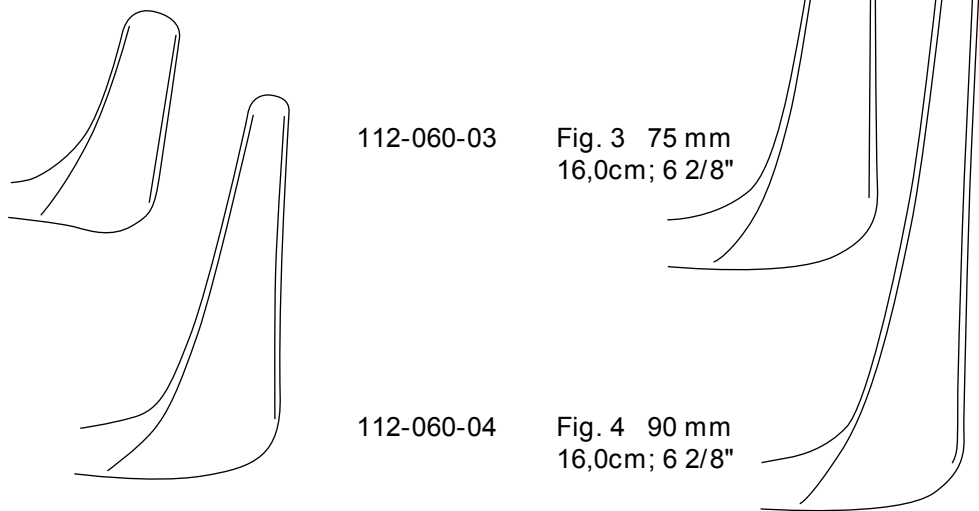

Nasenspekula
 Nasal specula
 Espéculos nasales



Art.Nr.	Beschreibung Description	Size	Spez.
	THUDICHUM	6,5cm; 2 4/8"	



112-064-01	Fig. 1	21 x 9,5 mm
112-064-02	Fig. 2	21 x 10,5 mm
112-064-03	Fig. 3	21 x 11,5 mm



Polypenschnürer
 Polypus snares
 Polipótomos

Art.Nr.	Beschreibung Description	Size	Spez.
112-110-00	KRAUSE 1 Aufsatz; Schaft Ø 3,0mm 1 tip; shaft Ø 3,0mm 1 punta; vástago Ø 3,0mm	26,0cm; 10 2/8"	



112-112-00	KRAUSE-VOSS 2 Aufsätze; Schaft Ø 3,0mm 2 tips; shaft Ø 3,0mm 2 puntas; vástago Ø 3,0mm	26,0cm; 10 2/8"	
------------	---	-----------------	--

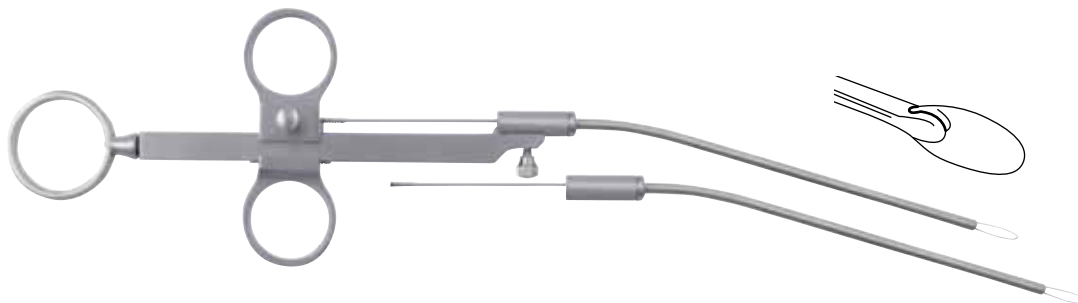

112-130-12	Schnürdraht; Bündel á 10 Stück Snare Wire; bundle with 10 pieces Asa de alambre; 10 piezas atados	Ø 0,3 mm	
------------	---	----------	--

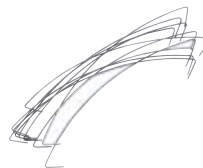

112-131-03	Schnürdraht; Rolle mit 10 m Snare Wire; coil of 10 m Asa de alambre; rollo de 10 m	Ø 0,3 mm	
------------	--	----------	--



112-131-04	Schnürdraht; Rolle mit 10 m Snare Wire; coil of 10 m Asa de alambre; rollo de 10 m	Ø 0,4 mm	
------------	--	----------	--



Nasentamponzangen
 Nasal Tampon Forceps
 Pinzas para taponamiento



Art.Nr.	Beschreibung Description	Size	Spez.
112-160-20	HARTMANN	20,0cm; 7 7/8"	

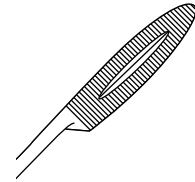
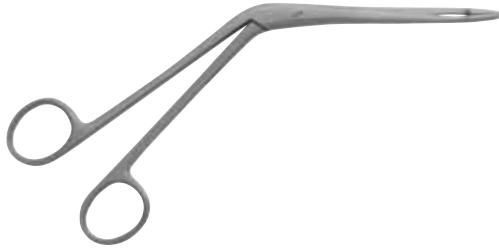

112-162-20	LUBET-BARBON glatt smooth lisa	18,5cm; 7 2/8"	
------------	---------------------------------------	----------------	--

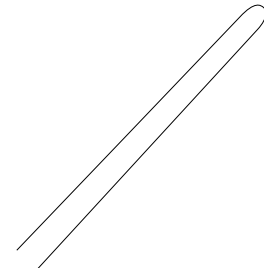

112-164-01	WESTMACOTT	18,5cm; 7 2/8"	
------------	------------	----------------	--

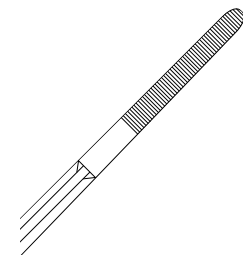

Rhinoplastik-Messer
 Rhinoplastic knives
 Cuchillos rinoplásticos

Art.Nr.	Beschreibung Description	Size	Spez.
112-200-02	JOSEPH Rhinoplastik-Messer	15,0cm; 5 7/8"	

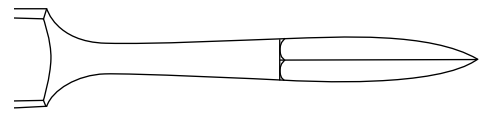

112-201-01	JOSEPH	15,0cm; 5 7/8"	
------------	--------	----------------	--

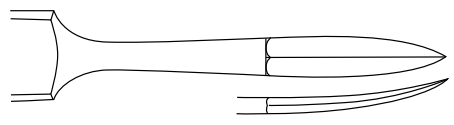

112-204-16	FOMON	16,5cm; 6 4/8"	
------------	-------	----------------	--

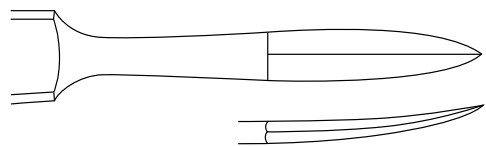

Rhinoplastik-Messer
 Rhinoplastic knives
 Cuchillos rinoplásticos



Art.Nr.	Beschreibung Description	Size	Spez.
---------	----------------------------	------	-------

112-206-15	COTTLE	14,0cm; 5 4/8"	
------------	--------	----------------	--



112-208-16	CONVERSE	16,0cm; 6 2/8"	
------------	----------	----------------	--



112-209-15	JOSEPH	15,5cm; 6 1/8"	
------------	--------	----------------	--

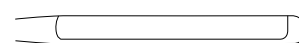

112-210-01	FREER Mukosamesser Mucosa knife Cuchillo para mucosa	16,5cm; 6 4/8"	
------------	---	----------------	--

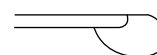

Rhinoplastikmesser; Schwingmesser
 Rhinoplastic knives; Swivel knives
 Cuchillos para tabique nasal

Art.Nr.	Beschreibung Description	Size	Spez.
112-222-21	HALLE	21,0cm; 8 2/8"	



112-224-22	ULRICH	23,0cm; 9"	
------------	--------	------------	--



	BALLENGER	21,0cm; 8 2/8"	
--	-----------	----------------	--



112-230-03	3,0 mm	
------------	--------	---

112-230-04	4,0 mm	
------------	--------	--

112-230-05	5,0 mm	
------------	--------	--

	BALLENGER	21,0cm; 8 2/8"	
--	-----------	----------------	--



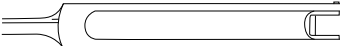

112-231-03	3,0 mm	
------------	--------	---

112-231-04	4,0 mm	
------------	--------	--

112-231-05	5,0 mm	
------------	--------	--

Septum elevator
 Septum Elevators
 Elevadores para tabique nasal

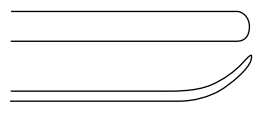

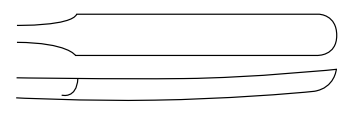
Art.Nr.	Beschreibung Description	Size	Spez.
	<p>MC KENTY</p> 	<p>15,0cm; 5 7/8"</p> 	
112-240-04	4,0 mm		
112-240-05	6,0 mm		
112-241-22	JOSEPH-MASING 	<p>21,5cm; 8 4/8" 4,0 mm</p> 	

Septum elevator
 Septum Elevators
 Elevadores para tabique nasal

Art.Nr.	Beschreibung Description	Size	Spez.
112-242-16	HALLE	16,0cm; 6 2/8" 3,5 mm	



112-243-16	JOSEPH	16,5cm; 6 4/8" 4,0 mm	
------------	--------	--------------------------	--



112-244-19	FREER scharf sharp agudo	19,0cm; 7 4/8" 5,0 mm	
------------	---------------------------------	--------------------------	--



112-245-19	FREER stumpf blunt romo	19,0cm; 7 4/8" 5,0 mm	
------------	--------------------------------	--------------------------	--



Septum elevator
 Septum Elevators
 Elevadores para tabique nasal



Art.Nr.	Beschreibung Description	Size	Spez.
---------	----------------------------	------	-------

FREER

112-246-18	scharf/stumpf; ohne Stift sharp/blunt; without pin agudo/romo; sin perno	18,0cm; 7 1/8" 5,0 mm	
------------	--	--------------------------	--



112-248-18	scharf/stumpf; mit Stift sharp/blunt; with pin agudo/romo; con perno	21,0cm; 8 2/8" 5,0 mm	
------------	--	--------------------------	--

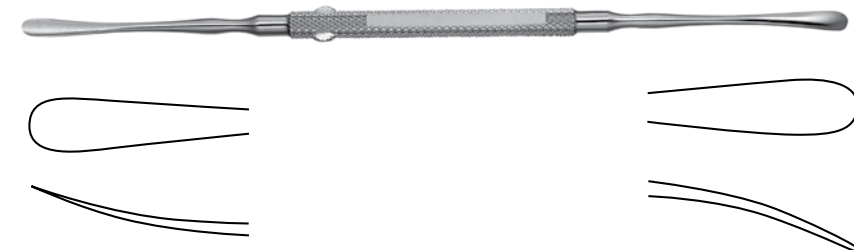

112-247-20	scharf/stumpf; ohne Stift sharp/blunt; without pin agudo/romo; sin perno	18,0cm; 7 1/8" 5,0 mm	
------------	--	--------------------------	--



Septum elevator
 Septum Elevators
 Elevadores para tabique nasal

Art.Nr.	Beschreibung Description	Size	Spez.
---------	----------------------------	------	-------

112-249-23	COTTLE	23,5cm; 9 2/8" 5,0 mm	
------------	--------	--------------------------	--

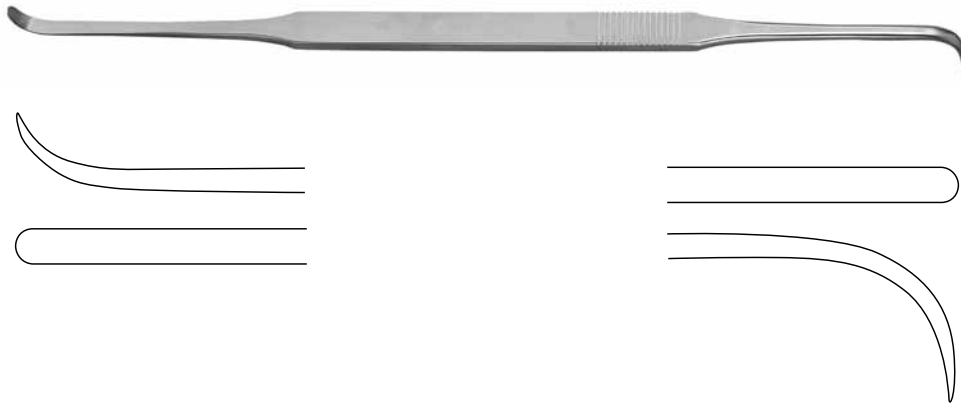

112-250-22	MC KENTY	20,5cm; 8 1/8" 5,0 mm	
------------	----------	--------------------------	--



112-252-21	COTTLE	22,0cm; 8 5/8" 5,0 mm	
------------	--------	--------------------------	--

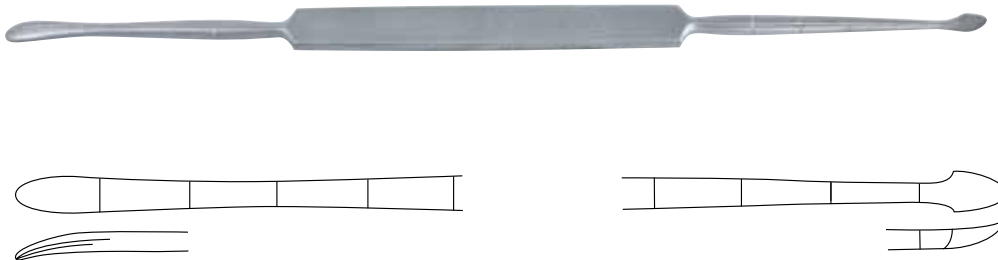

Septum elevator
 Septum Elevators
 Elevadores para tabique nasal



Art.Nr.	Beschreibung Description	Size	Spez.
112-253-21	MASING	19,5cm; 7 5/8" 5,0 mm	

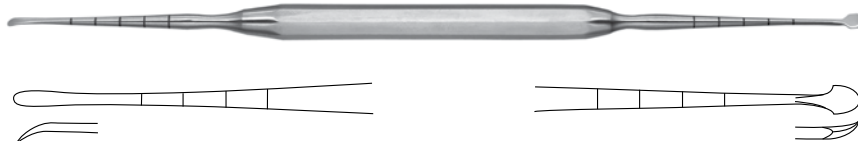

112-254-21	HOWARTH	21,5cm; 8 4/8" 5,0 mm	
------------	---------	--------------------------	--



112-255-18	KILLIAN	18,0cm; 7 1/8" 5,0 mm	
------------	---------	--------------------------	--

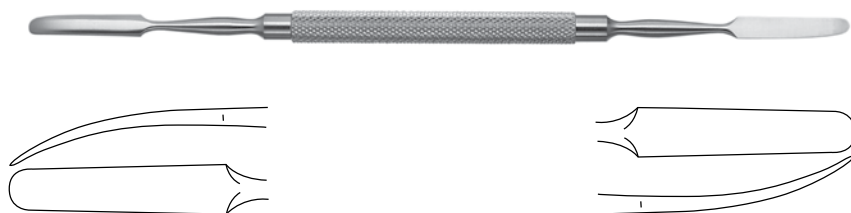

Septumelevatorien; Nasensägen
 Septum Elevators; Nasal Saws
 Elevadores para tabique nasal; sierra nasales

Art.Nr.	Beschreibung Description	Size	Spez.
112-256-22	KILLIAN	23,0cm; 9" 5,0 mm	

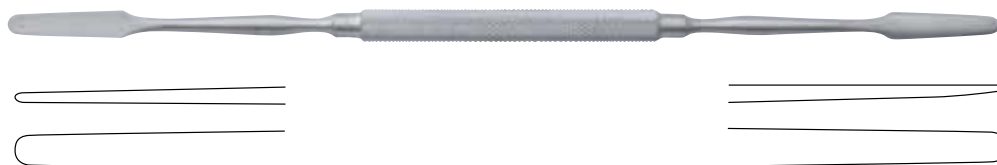

112-259-21	PENNINGTON	21,5cm; 8 4/8" 5,0 mm	
------------	------------	--------------------------	--



112-260-01	JOSEPH	links abgewinkelt angled to the left angulado por izquierdo	17,0cm; 6 6/8"
------------	--------	---	----------------



112-260-02	JOSEPH	rechts abgewinkelt angled to the right angulado por derecho	17,0cm; 6 6/8"
------------	--------	---	----------------



Nasensägen
Nasal Saws
Sierras nasales



Art.Nr.	Beschreibung Description	Size	Spez.
	JOSEPH	19,0cm; 7 4/8"	



112-262-00 gerade; 40mm Arbeitslänge
straight; 40mm working length
recto; longitud de la punta 40mm

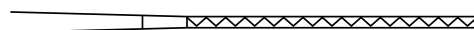

112-262-01 links; 40mm Arbeitslänge
left; 40mm working length
izquierda; longitud de la punta 40mm

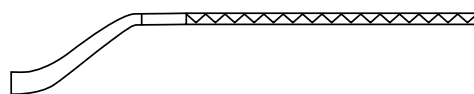

112-262-02 rechts; 40mm Arbeitslänge
right; 40mm working length
derecha; longitud de la punta 40mm



Nasenraspel
 Nasal rasps
 Escof nas nasales

Art.Nr.	Beschreibung Description	Size	Spez.
	MALTZ	17,0cm; 6 6/8"	



112-263-01 auf Zug schneidend
 drawing cut
 cortante a tracción

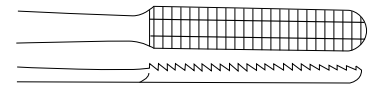

112-263-02 auf Druck schneidend
 pushing cut
 cortante a empuje

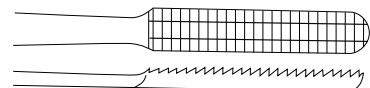

LEWIS

19,0cm; 7 4/8"



112-265-01 Fig. 1 auf Druck schneidend
 pushing cut
 cortante a empuje

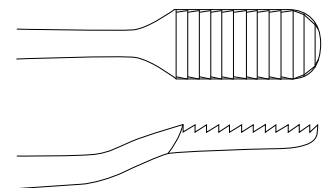

112-265-02 Fig. 2 auf Zug schneidend
 drawing cut
 cortante a tracción

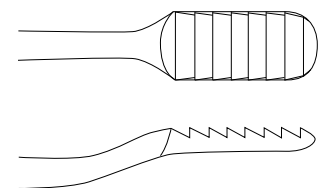

Nasenraspel
 Nasal rasps
 Escof nas nasales



Art.Nr.	Beschreibung Description	Size	Spez.
112-266-21	COTTLE	21,0cm; 8 2/8" 30 x 8 mm	

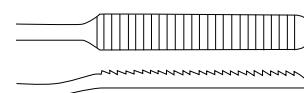

AUFRICHT

21,0cm; 8 2/8"



112-267-01	auf Druck schneidend pushing cut cortante a empuje
------------	--

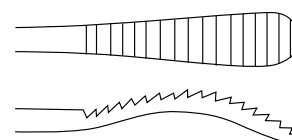

112-267-02	auf Zug schneidend drawing cut cortante a tracción
------------	--

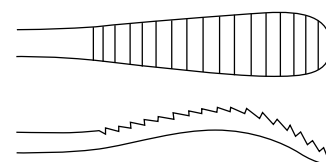

Nasenraspel
 Nasal rasps
 Escof nas nasales

Art.Nr.	Beschreibung Description	Size	Spez.
	JOSEPH	16,0cm; 6,4"	



112-269-01 Fig. 1
 fein | delicate | fino

60 x 8 m



112-269-02 Fig. 2;
 grob | gross | basto

45 x 9 mm

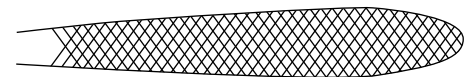

GALLAHER

17,0cm; 6 6/8"
 45 x 6 mm



112-270-00 gerade
 straight
 recto

112-270-01 links gebogen
 curved left
 curva á izquierda

112-270-02 rechts gebogen
 curved right
 curva á derecha

Nasenraspel
 Nasal rasps
 Escof nas nasales



Art.Nr.	Beschreibung Description	Size	Spez.
112-275-01	WIENER; Fig. 1	18,0cm; 7 1/8"	

spitz | sharp | agudo



112-275-02	WIENER; Fig. 2	18,0cm; 7 1/8"	
------------	----------------	----------------	--

stumpf | blunt | romo



112-277-01	FOMON	21,0cm; 8 2/8"	
------------	-------	----------------	--



112-278-21	MASING	21,0cm; 8 2/8"	
------------	--------	----------------	--



Nasenraspel
Nasal rasps
Escof nas nasales

Art.Nr.	Beschreibung Description	Size	Spez.
	MILLER	18,0cm; 7 1/8"	



112-284-01 Fig. 1; 8/5 mm

112-284-02 Fig. 2; 6/4 mm

112-284-03 Fig. 3; 6/5 mm

Nasenraspel
 Nasal rasps
 Escofnas nasales



Art.Nr.	Beschreibung Description	Size	Spez.
---------	----------------------------	------	-------

FOMON

20,5cm; 8 1/8"



112-295-01 Fig. 9/10

112-295-04 Fig. 3/4

112-295-02 Fig. 7/8

112-295-05 Fig. 1/2

112-295-03 Fig. 5/6

MALTZ

21,0cm; 8 2/8"



112-297-01 Fig. 1  12

112-297-06 Fig. 6  30

112-297-02 Fig. 2  14

112-297-07 Fig. 7  36

112-297-03 Fig. 3  16

112-297-08 Fig. 8  44

112-297-04 Fig. 4  20

112-297-09 Fig. 9  52

112-297-05 Fig. 5  24

112-297-10 Fig. 10  62

112

Schleimhauthaken
 Mucosa hooklets
 Ganchitos para mucosa

Art.Nr.	Beschreibung Description	Size	Spez.
112-300-01	JOSEPH	15,5cm; 6 1/8"	

scharf | sharp | agudo





	JOSEPH	16,0cm; 6 1/8"	
--	--------	----------------	--



112-300-02	2,0 mm	
------------	--------	---







112-300-05	5,0 mm	
------------	--------	---

112-300-07	7,0 mm	
------------	--------	---

112-300-10	10,0 mm	
------------	---------	---

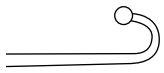
Nasenf ügelhäkchen
 Alar Hooks
 Ganchitos para alas de nariz

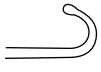

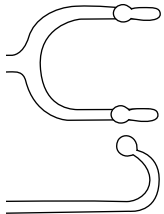
Art.Nr.	Beschreibung Description	Size	Spez.
112-302-16	COTTLE scharf sharp agudo	17,0cm; 6 6/8"	
			
112-303-17	FOMON geknöpft button ended abotonado	17,0cm; 6 6/8"	
			
112-304-22	LANGE geknöpft button ended abotonado	23,0cm; 9"	
			
112-305-16	FOMON geknöpft button ended abotonado	17,0cm; 6 6/8"	
			

112

Nasenhaken
 Nasal Retractors
 Separadores nasales

Art.Nr.	Beschreibung Description	Size	Spez.
	COTTLE scharf sharp agudo	14,5cm; 5 6/8"	



112-307-01	Fig. 1	
112-307-02	Fig. 2	
112-307-03	Fig. 3	

COTTLE	14,5cm; 5 6/8"
--------	----------------



112-308-00	scharf sharp agudo	
112-308-01	stumpf/scharf blunt/sharp romo/agudo	
112-308-02	scharf/stumpf sharp/blunt agudo/romo	

Nasenhaken
 Nasal Retractors
 Separadores nasales



Art.Nr.	Beschreibung Description	Size	Spez.
112-311-14	COTTLE	14,0cm; 5 4/8"	

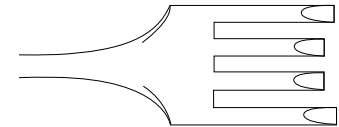

112-312-20	COTTLE-NEIVERT stumpf blunt romo	14,0cm; 5 4/8"	
------------	---	----------------	--



112-315-15	COTTLE stumpf blunt romo	16,0cm; 6 2/8"	
------------	---------------------------------	----------------	--



112-316-15	COTTLE stumpf blunt romo	14,0cm; 5 4/8"	
------------	---------------------------------	----------------	--



Nasenhaken
Nasal Retractors
Separadores nasales

Art.Nr.	Beschreibung Description	Size	Spez.
112-328-14	AUFRICHT(WALTER) stumpf blunt romo	12,0cm; 4 6/8"	



112-330-45	AUFRICHT stumpf blunt romo	19,0cm; 7 4/8" 45 x 11 mm	
------------	-----------------------------------	------------------------------	--



Antrumküretten
Antrum Curettes
Curetas para el antro



Art.Nr.	Beschreibung Description	Size	Spez.
---------	----------------------------	------	-------

COAKLEY

17,0cm; 6 4/8"



112-380-01

Fig. 1



112-380-04

Fig. 4



112-380-02

Fig. 2



112-380-05

Fig. 5



112-380-03

Fig. 3



112-380-06

Fig. 6



112-382-21

FAULKNER

21,0cm; 8 2/8"



112-385-20

SEWALL

20,0cm; 7 7/8"
6,0 mm



Osteotome, Meißel
 Osteotomes, Chisels
 Osteótomos, Cinceles

Art.Nr.	Beschreibung Description	Size	Spez.
---------	----------------------------	------	-------

112-500-16	FREER	16,0cm; 6 2/8" 4,0 mm	
------------	-------	--------------------------	--

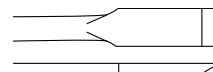

112-501-16	FREER	16,0cm; 6 2/8" 4,0 mm	
------------	-------	--------------------------	--

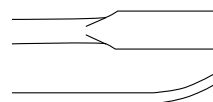

	WEST	16,0cm; 6 2/8"	
--	------	----------------	--



112-502-16	4,0 mm	16,0cm; 6 2/8"	
112-502-19	6,0 mm		

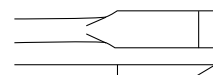

WEST







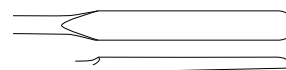

112-503-16	4,0 mm	16,0cm; 6 2/8"	
------------	--------	----------------	--

112-503-19	6,0 mm	19,0cm; 7 4/8"	
------------	--------	----------------	--

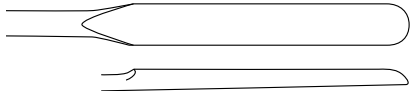

Hohlmeißel
Gouge
Gubias

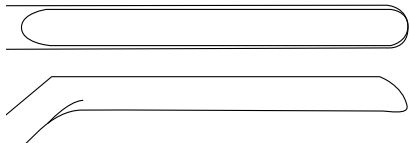

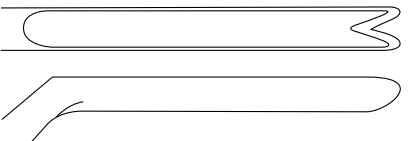
Art.Nr.	Beschreibung Description	Size	Spez.
112-504-06	FREER	16,0cm; 6 2/8" 6,0 mm	
			
	BALLENGER	15,0cm; 5 7/8"	
			
112-505-02	2,0 mm		
112-505-04	4,0 mm		
112-505-06	6,0 mm		
112-505-08	8,0 mm		
			
112-506-05	KILLIAN	16,0cm; 6 2/8" 5,0 mm	
			
112-507-05	KILLIAN-CLAUS	16,0cm; 6 2/8" 5,0 mm	
			

Osteotome
 Osteotomes
 Osteótomos

Art.Nr.	Beschreibung Description	Size	Spez.
---------	----------------------------	------	-------

COTTLE

18,5cm; 7 2/8"



- 112-508-04 4,0 mm
- 112-508-07 7,0 mm
- 112-508-09 9,0 mm
- 112-508-12 12,0 mm

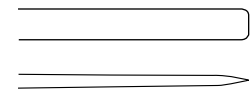

112-509-06 COTTLE

18,5cm; 7 2/8"
 6,0 mm

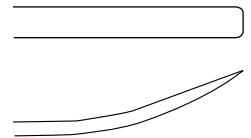

112-510-06 COTTLE

18,5cm; 7 2/8"
 6,0 mm

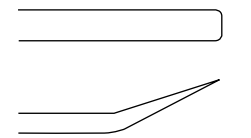

COTTLE

18,5cm; 7 2/8"



- 112-511-04 4,0 mm
- 112-511-07 7,0 mm
- 112-511-09 9,0 mm
- 112-511-12 12,0 mm



Osteotome, Meißel
 Osteotomes, Chisels
 Osteótomos, Cinceles



Art.Nr.	Beschreibung Description	Size	Spez.
---------	----------------------------	------	-------

112-512-16	COTTLE	18,5cm; 7 2/8" 16,0 mm	
------------	--------	---------------------------	--



112-513-16	COTTLE	18,5cm; 7 2/8" 16,0 mm	
------------	--------	---------------------------	--



	WALTER	19,0cm; 7 4/8"	
--	--------	----------------	--



112-533-03	3,0 mm	
------------	--------	--

112-533-04	4,0 mm
------------	--------

	WALTER	19,0cm; 7 4/8"	
--	--------	----------------	--



112-534-03	3,0 mm	
------------	--------	--

112-534-04	4,0 mm
------------	--------

112-534-07	7,0mm
------------	-------

112-534-09	9,0 mm
------------	--------

112-534-12	12,0 mm
------------	---------

112

Osteotome, Meißel
 Osteotomes, Chisels
 Osteótomos, Cinceles

Art.Nr.	Beschreibung Description	Size	Spez.
---------	----------------------------	------	-------

RUBIN

18,5cm; 7 2/8"



112-536-10 10,0 mm

112-536-12 12,0 mm

112-536-14 14,0 mm

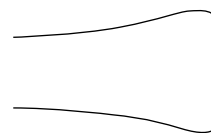

FOMON

16,0cm; 6 2/8"



112-537-04 4,0 mm

112-537-05 5,0 mm

112-537-06 6,0 mm

112-537-07 7,0 mm



CINELLI

16,0cm; 6 2/8"



112-538-10 10,0 mm

112-538-12 12,0 mm

112-538-14 14,0 mm

112-538-16 16,0 mm

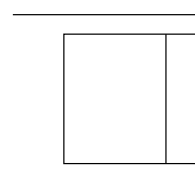

Nasenmeißel
Rhinoplastic chisel
Cinceles



Art.Nr.	Beschreibung Description	Size	Spez.
	SILVER	18,0cm; 7 1/8" 5,0 mm	

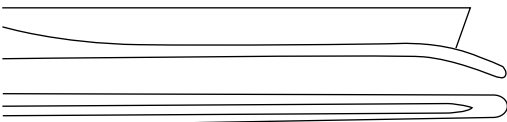

112-542-00	gerade straight recto	
------------	-----------------------------	---

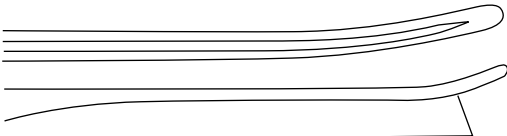
112-542-01	links left izquierdo	
------------	----------------------------	--

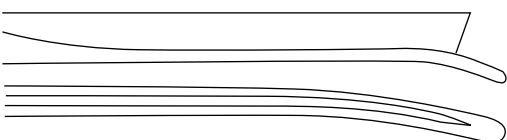
112-542-02	rechts right derecho	
------------	----------------------------	---

NEIVERT-ANDERSON

20,5cm; 8 1/8"
7,0 mm

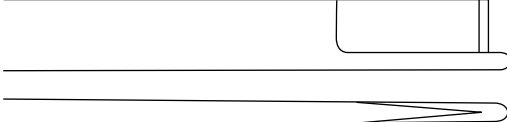

112-543-00	gerade straight recto	
------------	-----------------------------	---

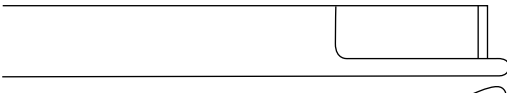
112-543-01	links left izquierdo	
------------	----------------------------	---

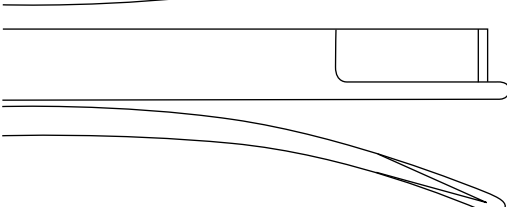
112-543-02	rechts right derecho	
------------	----------------------------	---

112

Nasenmeißel; Ringmesser
 Rhinoplastic chisel; Adenoid currettes
 Cinceles; cuchillos para adenoides

Art.Nr.	Beschreibung Description	Size	Spez.
112-545-00	PARKES	16,0cm; 6 2/8"	

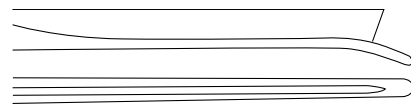

BECKMANN

22,0cm; 8 5/8"

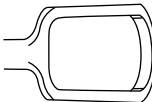
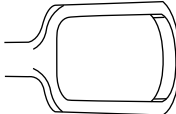
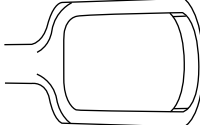
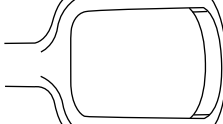
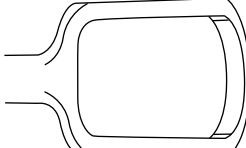
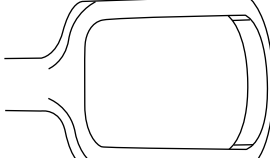

112-600-01	Fig. 1	13,0mm	
112-600-02	Fig. 2	15,0mm	
112-600-03	Fig. 3	17,0mm	
112-600-04	Fig. 4	19,0mm	
112-600-05	Fig. 5	21,0mm	
112-600-06	Fig. 6	23,0mm	

Ringmesser
 Adenoid currettes
 Cuchillos para adenoides



Art.Nr.	Beschreibung Description	Size	Spez.
	BECKMANN	22,0cm; 8 5/8"	



112-601-01	Fig. 1	13,0 mm	
112-601-02	Fig. 2	15,0 mm	
112-601-03	Fig. 3	17,0 mm	
112-601-04	Fig. 4	19,0 mm	
112-601-05	Fig. 5	21,0 mm	
112-601-06	Fig. 6	23,0 mm	

112

Hautfasspinzetten; Septumrichtzange
 Skin grasping forceps; septum straightening forceps
 Pinzas para piel; pinzas enderezar el tabique nasal

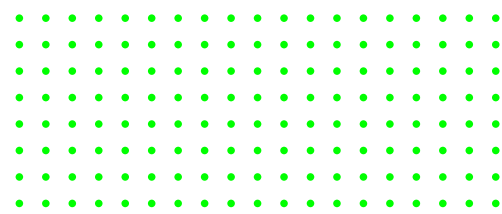

Art.Nr.	Beschreibung Description	Size	Spez.
112-640-14	COTTLE	14,0cm; 5 4/8"	

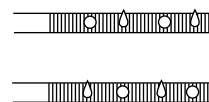

112-642-10	COTTLE Columellapinzette Columella Forceps Pinza para columela	11,0cm; 4 3/8" 12,0 mm	
------------	---	---------------------------	--

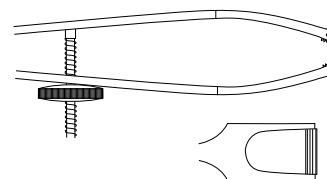

112-650-23	ASCH	22,5cm; 8 7/8"	
------------	------	----------------	--



Septumrichtzange
 Septum straightening forceps
 Pinzas enderezar el tabique nasal



Art.Nr.	Beschreibung Description	Size	Spez.
	WALSHAM	23,0cm; 9"	



- 112-651-00 gerade | straight | recto
- 112-651-01 links | left | izquierdo
- 112-651-02 rechts | right | derecho

112-654-60	KRESSNER	22,0cm; 8 5/8"	
------------	----------	----------------	--



112

Septumquetschzange, Knorpelquetsche
 Septum Morselizers, Cartilage Crusher
 Pinzas para aplastamiento, Machacadora

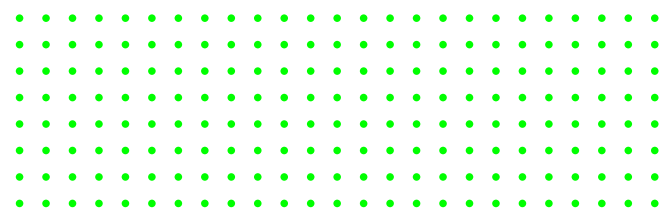

Art.Nr.	Beschreibung Description	Size	Spez.
112-653-20	RUBIN	18,5cm; 7 2/8"	

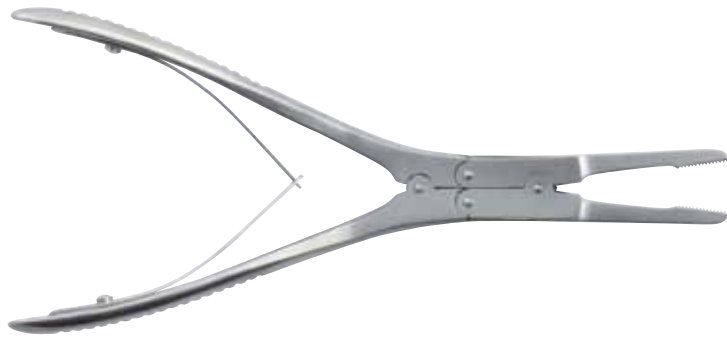

112-656-00	COTTLE	Knorpelquetsche cartilage crusher machacadora	65 x 30 x 30 mm
------------	--------	---	-----------------







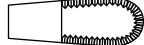

112-655-01	COTTLE	Griff Handle Mango	
------------	--------	--------------------------	--

112-655-02	COTTLE	Führungshilfe für Osteotome Guide Support for osteotomes Soporte de guía para osteótomes	
------------	--------	--	--

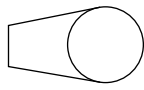

Nasenzangen
 Nasal forceps
 Pinzas nasales



Art.Nr.	Beschreibung Description	Size	Spez.
113-103-12	WATSON-WILLIAMS 	120 mm 	
113-105-01	WATSON-WILLIAMS 	120 mm 	
	HARTMANN 	120 mm	
113-110-05	Fig. 1 5,0 mm 		
113-110-07	Fig. 2 7,0 mm 		
113-110-09	Fig. 3 9,0 mm 		
113-110-11	Fig. 4 11,0 mm 		

113

Nasenzangen
 Nasal forceps
 Pinzas nasales

Art.Nr.	Beschreibung Description	Size	Spez.
---------	----------------------------	------	-------

113-114-02

SCHMIEDEN



120 mm
 Ø 8,0 mm

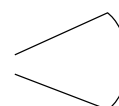

STRUYCKEN

120 mm



113-115-01

Fig. 1

Ø 0,9 mm



113-115-02

Fig. 2

Ø 1,2 mm



TAKAHASHI

120 mm
 3 x 10 mm



113-120-30

gerade | straight | recto

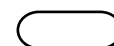

113-121-30

aufgebogen | curved up
 acodada hacia arriba

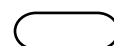

Septumzangen
 Septum Forceps
 Pinzas para tabique nasal



Art.Nr.	Beschreibung Description	Size	Spez.
113-125-19	JANSEN-MIDDLETON durchschneidend through-cutting cortante	20,5cm; 8 1/8"	



113-126-19	JANSEN-MIDDLETON	20,5cm; 8 1/8"	
------------	------------------	----------------	--

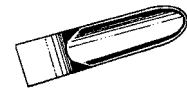

113-130-17	GRAIG	16,0cm; 6 2/8"	
------------	-------	----------------	--



Septumzangen
 Septum Forceps
 Pinzas para tabique nasal

Art.Nr.	Beschreibung Description	Size	Spez.
---------	----------------------------	------	-------

GRAIG-DOMNICK

15,5cm; 6 1/8"



113-131-17

links gebogen
 left curved
 curvo por izquierdo



113-132-17

rechts gebogen
 right curved
 curvo por derecho

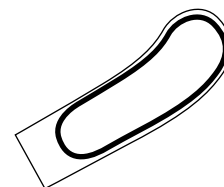

BRUENINGS

16,5cm; 6 4/8"



113-135-01

Fig. 1



113-135-03

Fig. 3

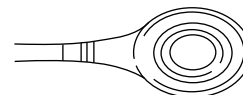

113-135-02

Fig. 2



113-135-04

Fig. 4



Septumzangen
 Septum Forceps
 Pinzas para tabique nasal



Art.Nr.	Beschreibung Description	Size	Spez.
	LUC Septumzange	19,0cm; 7 4/8"	



113-136-01

Fig. 1

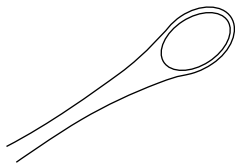

113-136-02

Fig. 2

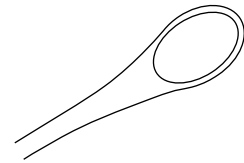

113-138-18

KNIGHT

17,0cm; 6 6/8"

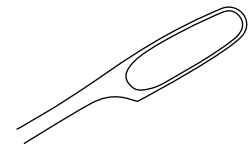

113

Nasenzangen
 Nasal forceps
 Pinzas nasales

Art.Nr.	Beschreibung Description	Size	Spez.
	HAJEK-KOFLER	140 mm	



113-170-14 4 x 4 mm
 aufwärts schneidend
 up cutting
 cortante por arriba

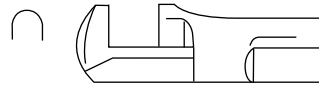

113-171-14 4 x 4 mm
 abwärts schneidend
 down cutting
 cortante por abajo

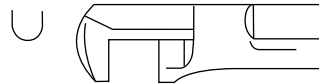

113-172-14 3,5 x 3,5 mm
 aufwärts schneidend
 up cutting
 cortante por arriba

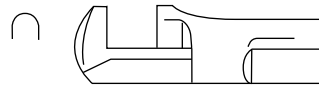

113-173-14 3,5 x 3,5 mm
 abwärts schneidend
 down cutting
 cortante por abajo



Nasenzangen
Nasal forceps
Pinzas nasales



Art.Nr.	Beschreibung Description	Size	Spez.
	WEIL-BLAKESLEY	120 mm	



113-200-01	Fig. 1	2,5mm	
113-200-02	Fig. 2	3,6mm	
113-200-03	Fig. 3	4,2mm	
113-200-04	Fig. 4	4,8mm	
113-200-05	Fig. 5	5,8mm	

	WEIL-BLAKESLEY	120 mm	45°
--	----------------	--------	-----



113-201-01	Fig. 1	2,5mm	
113-201-02	Fig. 2	3,6mm	
113-201-03	Fig. 3	4,2mm	
113-201-04	Fig. 4	4,8mm	

113

Nasenzangen
 Nasal forceps
 Pinzas nasales



Art.Nr.	Beschreibung Description	Size	Spez.
	WEIL-BLAKESLEY	120 mm	90°



113-203-01	Fig. 1	2,5mm	
113-203-02	Fig. 2	3,6mm	
113-203-03	Fig. 3	4,2mm	
113-203-04	Fig. 4	4,8mm	

Antrumstanze
 Antrum punch
 Pinza saca-bocada para seno maxilar

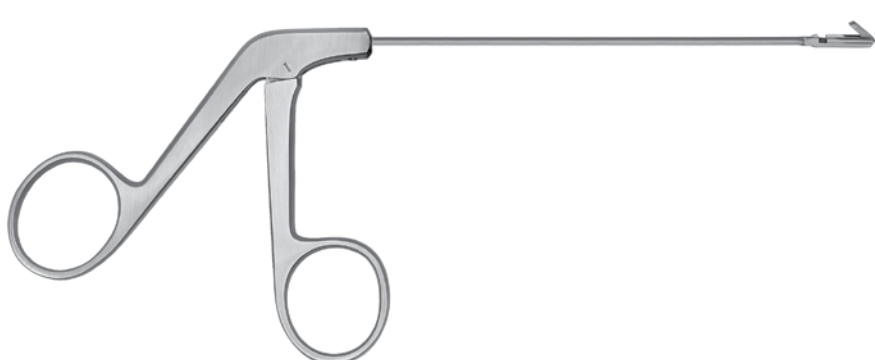

Art.Nr.	Beschreibung Description	Size	Spez.
		100 mm 2,5 mm 	
113-250-01	retrograd aufwärts schneidend retrograde; up cutting retrógrado; cortante en la parte superior		
113-250-02	retrograd rechts schneidend retrograde; right cutting retrógrado; cortante e la derecha		
113-250-03	retrograd links schneidend retrograde; left cutting retrógrado; cortante a la izquierda		

Fingerschutz; Mundkeile
Finger Protector; Mouth Gags
Dedal; Abrebocas

Art.Nr.	Beschreibung Description	Size	Spez.
114-115-02	LANGENBECK	Ø 26/ 20 mm	



114-118-00	MAUNDER Holz wood madera	9,5cm; 3 6/8"	
------------	--------------------------------	---------------	--



114-121-00	PITHA Silikon silicone silicona	28 x 30 mm	
------------	---------------------------------------	------------	--



Mundsperrer
Mouth gags
Abreboca



Art.Nr.	Beschreibung Description	Size	Spez.
114-130-13	HEISTER	13,0cm; 5 1/8"	



114-140-11	MOLT	11,0cm; 4 3/8"	
------------	------	----------------	--



114-140-14	MOLT	13,0cm; 5 1/8"	
------------	------	----------------	--



Mundsperrer
 Mouth gags
 Abreboca

Art.Nr.	Beschreibung Description	Size	Spez.
114-142-12	DENHART	13,0cm; 5 1/8"	

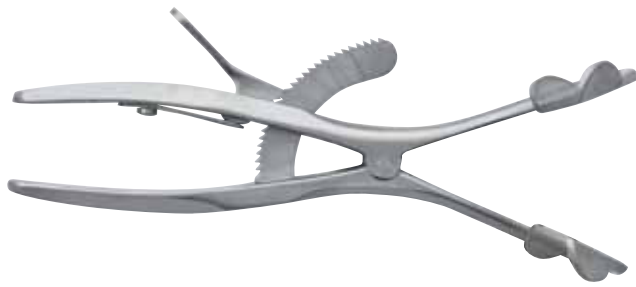

ROSER-KÖNIG



114-144-16 16,0cm; 6 2/8"

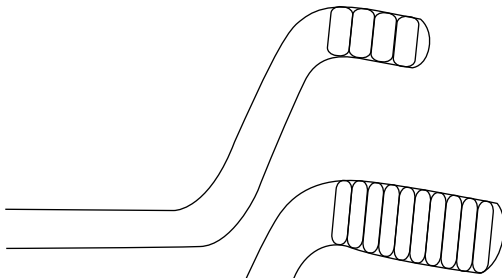

114-144-19 19,0cm; 7 4/8"



Mundsperrer
 Mouth gags
 Abreboca



Art.Nr.	Beschreibung Description	Size	Spez.
---------	----------------------------	------	-------

ORINGER



114-243-00	für Kinder for children para niños	9,5cm; 3 6/8"	
------------	--	---------------	--

114-243-01	Fig. 1	10,0cm; 3 7/8"	
114-243-02	Fig. 2	10,5cm; 4 1/8"	
114-243-03	Fig. 3	11,0cm; 4 3/8"	

114-243-13	Set mit Figur 1-3 Set with no. 1-3 juego de no. 1-3		
------------	---	--	--

SET

JENNINGS



114-246-09	10,5cm; 4 1/8"		
114-246-11	12,5cm; 4 7/8"		
114-246-13	14,5cm; 5 6/8"		
114-246-15	16,5cm; 6"		

Mundsperrer
 Mouth gags
 Abreboca

Art.Nr. Beschreibung | Description Size Spez.

KILNER-DOUGHTY



114-260-00 mit Spateln und Zahnplatten
 with tongue depressors and toothplates
 con bajalenguas y plaquitas de dientes

SET

Zungendrucker allein
 tongue depressor only
 bajalengua solo

114-260-01 Fig. 1 68 x 30 mm
 114-260-02 Fig. 2 77 x 34 mm
 114-260-03 Fig. 3 82 x 39 mm



114-260-04 Mundsperrer-Rahmen
 frame for mouth gags
 bastidor para abreboca

114-260-08 Gaumenplatte
 palate plate
 plaquita paldia

Mundsperrer
 Mouth gags
 Abreboca



Art.Nr.	Beschreibung Description	Size	Spez.
---------	----------------------------	------	-------

DINGMANN

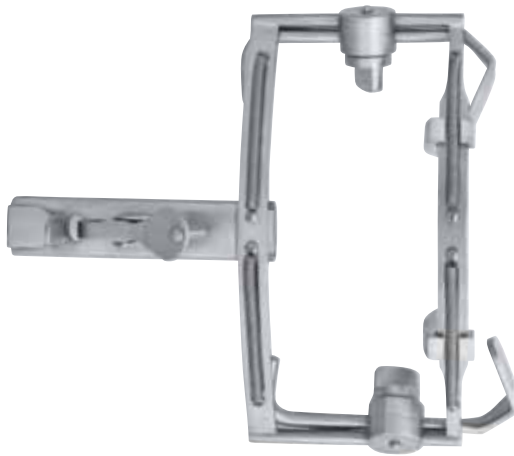

114-261-00	mit Spateln und Valven with tongue depressors and valves con bajalenguas y valves	<div style="border: 1px solid black; padding: 5px; display: inline-block;">SET</div>
	Zungendrucker allein tongue depressor only bajalengua solo	

SET

Zungendrucker allein
 tongue depressor only
 bajalengua solo

114-261-01	Fig. 1	62 x 26 mm	
------------	--------	------------	--



114-261-02	Fig. 2	65 x 30 mm	
------------	--------	------------	--



114-261-03	Fig. 3	78 x 32 mm	
------------	--------	------------	--



114

Mundsperrer
 Mouth gags
 Abreboca

Art.Nr.	Beschreibung Description	Size	Spez.
---------	----------------------------	------	-------

DAVIS-BOYLE



114-264-00 mit Spateln und Valven
 with tongue depressors and valves
 con bajalenguas y valves

SET

Zungendrucker allein
 tongue depressor only
 bajalengua solo

114-264-01	Fig. 1	110 x 28 mm
114-264-02	Fig. 2	95 x 27 mm
114-264-03	Fig. 3	80 x 27 mm
114-264-04	Fig. 4	65 x 26 mm
114-264-05	Fig. 5	30 x 20 mm



114-264-06 Mundsperrer-Rahmen
 frame for mouth gags
 bastidor para abreboaca

Mundsperrer
 Mouth gags
 Abreboca



Art.Nr.	Beschreibung Description	Size	Spez.
---------	----------------------------	------	-------

MCIVOR



114-266-00

mit Spateln
 with tongue depressors
 con bajalenguas

SET

Zungendrucker allein
 tongue depressor only
 bajalengua solo

114-266-01

Fig. 1

100 x 25 mm

114-266-02

Fig. 2

85 x 25 mm

114-266-03

Fig. 3

75 x 25 mm



114-266-04

Mundsperrer-Rahmen
 frame for mouth gags
 bastidor para abreboca

114

Lippen- und Wangenhalter
 Lip and Cheek Retractors
 Separadores para labios y mejillas

Art.Nr.	Beschreibung Description	Size	Spez.
114-400-11	SIMPLEX	10,5cm; 4 1/8"	



114-405-14	STERNBERG	14,0cm; 5 4/8" 26 mm / 37 mm	
------------	-----------	---------------------------------	--

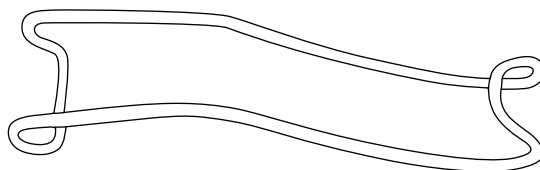

114-410-14	BISHOP	13,5cm; 5 3/8"	
------------	--------	----------------	--









114-445-14	MINNESOTA	15,5cm; 6 1/8"	
------------	-----------	----------------	--

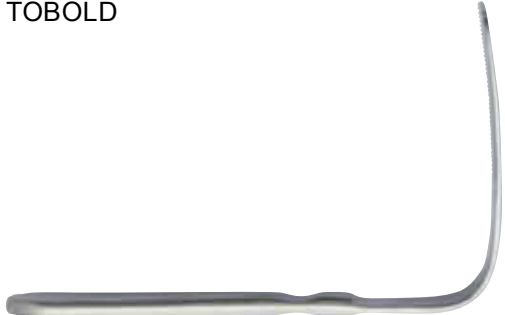

Zungendrucker
Tongue depressor
Bajalengua

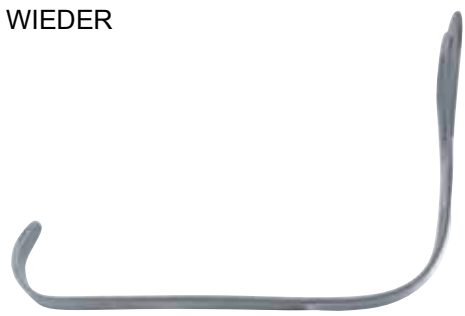
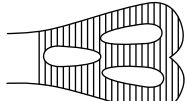
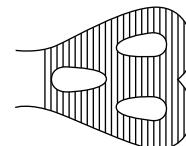

Art.Nr.	Beschreibung Description	Size	Spez.
114-434-14	TOBOLD 	16,0cm; 6 2/8" 80 x 25 mm	
114-435-14	TOBOLD 	15,0cm; 5 7/8" 83 x 25 mm	
114-436-15	HARTMANN 	15,0cm; 5 7/8" 72 x 24 mm	
	WIEDER 		
114-440-14	Fig. 1 36 mm 	14,0cm; 5 4/8"	
114-440-15	Fig. 2 43 mm 	15,0cm; 5 7/8"	

114

Zungenspatel
 Tongue Spatulas
 Espátulas linguales

Art.Nr.	Beschreibung Description	Size	Spez.
114-460-19	BRÜNINGS	19,0cm; 7 4/8" 15 mm / 19 mm	



DOYEN



114-463-13	23 x 30 mm	13,0cm; 5 1/8"
114-463-16	30 x 33 mm	16,0cm; 6 2/8"

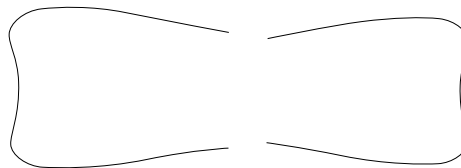

Zungenzange
Tongue holding forceps
Pinza tira-lengua



Art.Nr.	Beschreibung Description	Size	Spez.
114-480-16	COLLIN	17,0cm; 6 6/8"	

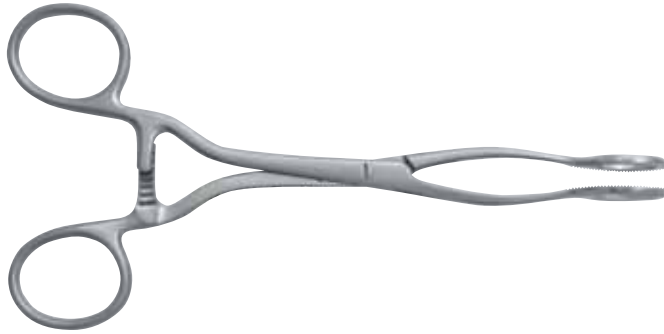

114-484-17	YOUNG	15,0cm; 5 7/8"	
------------	-------	----------------	--



114-484-99	YOUNG	Gummipolster; 1 Paar rubber inserts for tongue holding forceps bocas de goma; par	
------------	-------	---	--

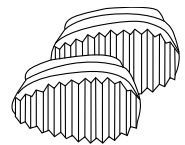

Repositionzange; Zygoma-Elevatorium
 Disimpaction forceps; zygoma elevators
 Pinza para reposición; elevadores cigomáticos

Art.Nr. Beschreibung | Description Size Spez.

ROWE

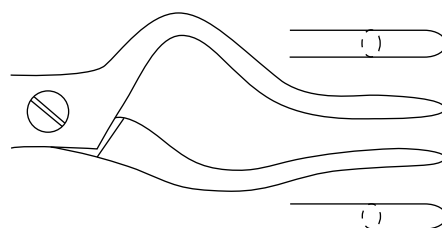

		links left izquierdo	rechts right derecho
21,5cm; 8 4/8"	für Säuglinge for babies para recién nacidos	114-490-01	114-491-01
24,0cm; 9 4/8"	für Kinder for children para niños	114-490-02	114-491-02
24,5cm; 9 5/8"	für Erwachsene for adults para adultos	114-490-03	114-491-03

114-500-20

GILLIES

20,0cm; 7 7/8"

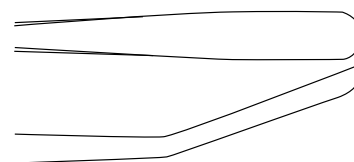

Knochenhaltezange; Spreizzange
 Bone holding forceps; ramus separator
 Pinza para huesos; pinza para separar la rama



Art.Nr.	Beschreibung Description	Size	Spez.
114-502-01	STEINHÄUSER	13,5cm; 5 3/8"	



114-502-02	STEINHÄUSER	12,5cm; 4 7/8"	
------------	-------------	----------------	--



114-510-23	SMITH	23,5cm; 9 2/8"	
------------	-------	----------------	--



Mylohyoideusklemme
Mylohyoid muscle clamp
Pinza para el músculo milohioideo

Art.Nr.	Beschreibung Description	Size	Spez.
	TERRY	17,0cm; 6 6/8"	



114-515-01
links
left
izquierdo

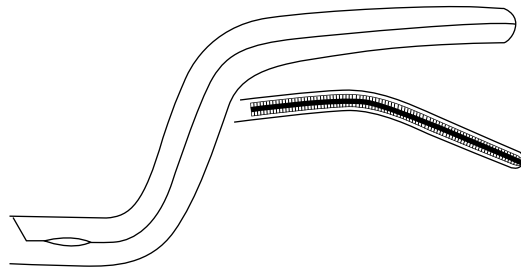

114-515-02
rechts
right
derecho

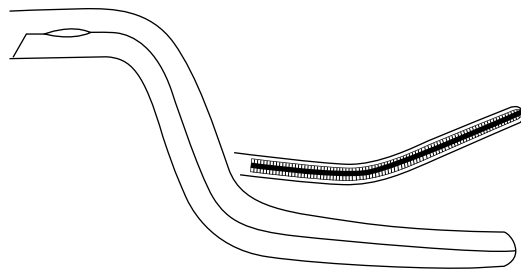

Palatumspreizer; Ramusklemme
 Palatal expander; Ramus clamp
 Separator paladial; Pinza de rama



Art.Nr.	Beschreibung Description	Size	Spez.
114-516-17	TURVEY	17,0cm; 6 6/8"	

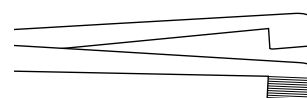

STEINHÄUSER

16,0cm; 6 2/8"

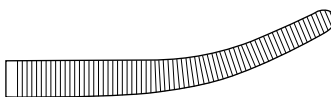

114-518-01 links
left
izquierdo

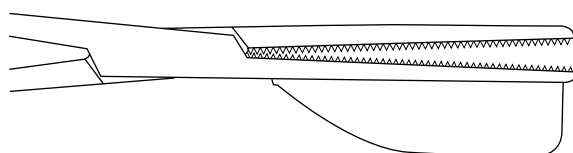

114-518-02 rechts
right
derecho

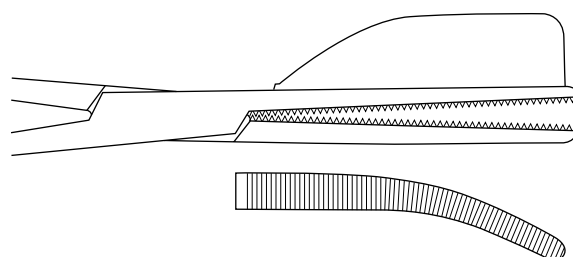

114

Osteotom
 Osteotome
 Osteótomos

Art.Nr.	Beschreibung Description	Size	Spez.
	BAUER	20,5cm; 8 1/8"	



114-550-06	6,0 mm	
114-550-08	8,0 mm	

	BAUER	20,5cm; 8 1/8"	
--	-------	----------------	--



114-551-06	6,0 mm	
114-551-08	8,0 mm	

114-552-08	EPKER-BAUER	17,5cm; 6 7/8" 8,0 mm	
------------	-------------	--------------------------	--

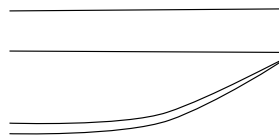

Osteotome; Raspatorien
 Osteotomes; Periosteal Elevators
 Osteótomes; Periostómos



Art.Nr.	Beschreibung Description	Size	Spez.
---------	----------------------------	------	-------

EPKER	graduier graduated graduada	18,0cm; 7 1/8"	
-------	-----------------------------------	----------------	--



114-560-04	4,0 mm
114-560-06	6,0 mm
114-560-08	8,0 mm



EPKER	graduier graduated graduada	18,0cm; 7 1/8"	
-------	-----------------------------------	----------------	--



114-561-04	4,0 mm
114-561-06	6,0 mm

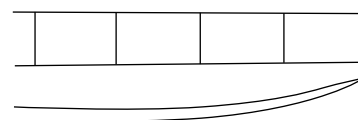

OBWEGESER		18,0cm; 7 1/8"	
-----------	--	----------------	--



114-570-06	6,0 mm
114-570-07	7,0 mm
114-570-09	9,0 mm
114-570-11	11,0 mm

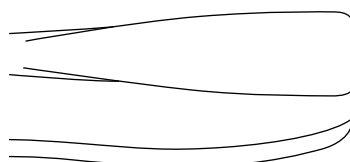

114

Art.Nr.	Beschreibung Description	Size	Spez.
	OBWEGESER	18,0cm; 7 1/8"	



114-580-06	Fig. 1	6,0 mm	
114-580-07	Fig. 2	7,0 mm	
114-580-09	Fig. 3	9,0 mm	
114-580-11	Fig. 4	11,0 mm	

	OBWEGESER	20,0cm; 8"
--	-----------	------------



114-581-05	5,0 mm	
114-581-07	7,0 mm	
114-581-09	9,0 mm	

	OBWEGESER	17,5cm; 6 7/8"
--	-----------	----------------



114-582-01	Fig. 1	6,0mm
114-582-02	Fig. 2	7,0mm

Osteotome
 Osteotomes
 Osteótomes



Art.Nr.	Beschreibung Description	Size	Spez.
---------	----------------------------	------	-------

OBWEGESER **graduiert**
graduated
graduada

19,0cm; 7 4/8"



- 114-583-04 Fig. 1 4,0 mm
- 114-583-06 Fig. 2 6,0 mm
- 114-583-08 Fig. 3 8,0 mm

OBWEGESER

22,5cm; 8 7/8" FERROZELL



- 114-590-08 8,0 mm
- 114-590-12 12,0 mm
- 114-590-16 16,0 mm

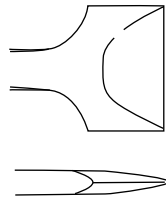

OBWEGESER

22,5cm; 8 7/8" FERROZELL



- 114-592-08 8,0 mm
- 114-592-12 12,0 mm
- 114-592-16 16,0 mm
- 114-592-20 20,0 mm

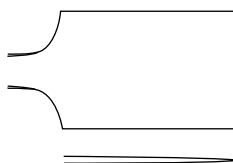

114

Osteotome
 Osteotomes
 Osteótomes

Art.Nr.	Beschreibung Description	Size	Spez.
	OBWEGESER	15,5cm; 6 1/8"	



114-595-03
 114-595-04
 114-595-06

3,0 mm
 4,0 mm
 6,5 mm

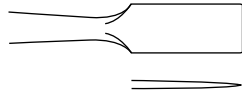

114-597-12

OBWEGESER Maxilla-Mobilisator
 maxillary mobilizer
 mobilizador maxilar

23,0cm; 9"
 12,0 mm

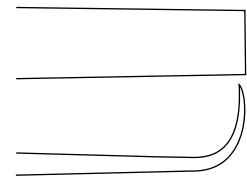

Weichteilhaken
Soft tissue retractor
Separadore para partes blandes



Art.Nr. Beschreibung | Description Size Spez.

OBWEGESER nach oben gebogen
curved up
angulado hacia arriba



114-600-25	25 x 7 mm	21,0cm; 8 2/8"
114-600-35	35 x 10 mm	23,0cm; 8 2/8"
114-600-42	42 x 10 mm	23,0cm; 9"
114-600-55	55 x 12 mm	23,0cm; 9"
114-600-70	70 x 14 mm	23,5cm; 9 2/8"
114-600-80	80 x 16 mm	24,0cm; 9 2/8"

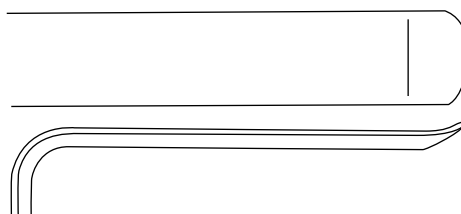

OBWEGESER nach unten gebogen
curved down
angulado hacia abajo



114-601-16	16 x 5 mm	21,0cm; 8 2/8"
114-601-25	25 x 7 mm	21,0cm; 8 2/8"
114-601-35	35 x 10 mm	23,0cm; 9"
114-601-42	42 x 10 mm	23,0cm; 9"
114-601-55	55 x 12 mm	23,5cm; 9 2/8"
114-601-70	70 x 14 mm	23,5cm; 9 2/8"
114-601-80	80 x 16 mm	23,5cm; 9 2/8"

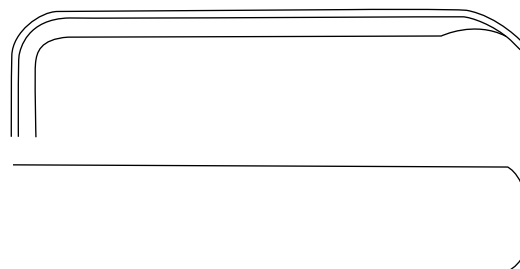

OBWEGESER nach oben gebogen
curved up
angulado hacia arriba



114-610-40	43 x 11 mm	22,5cm; 8 7/8"
114-610-55	57 x 11 mm	23,0cm; 9"
114-610-80	80 x 11 mm	23,0cm; 9"

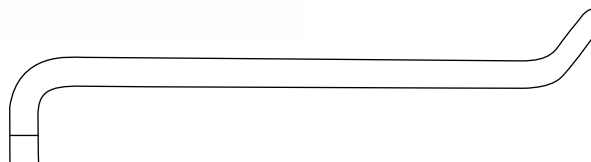

114

Weichteilhaken
Soft tissue retractor
Separadore para partes blandes

Art.Nr.	Beschreibung Description	Size	Spez.
---------	----------------------------	------	-------

114-615-22	OBWEGESER spina nasalis-Haken nasal spine retractor separador para spina nasalis	22,0cm; 8 5/8" 43 x 10 mm	
------------	--	------------------------------	--

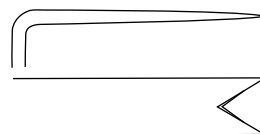

114-617-22	OBWEGESER Ramushaken ramus retractor separador para el ramo	22,0cm; 8 5/8" 72 x 10 mm	
------------	---	------------------------------	--

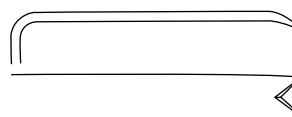

114-620-16	OBWEGESER Kinnhalter chin retractor gancho de mentón	16,5cm; 6 4/8"	
------------	--	----------------	--



	OBWEGESER Progenierinne channel retractor separador mandibulares	16,0cm; 6 2/8"	
--	--	----------------	--



114-625-08 8,0 mm

114-625-10 10,0 mm

Weichteilhaken
Soft tissue retractor
Separadore para partes blandes



Art.Nr.	Beschreibung Description	Size	Spez.
---------	----------------------------	------	-------

	OBWEGESER Ramushaken ramus retractor separador para el ramo	24,0cm; 9 4/8"	
--	---	----------------	--



114-635-22	75 x 11/15mm
------------	--------------



114-637-22	75 x 12/22mm
------------	--------------



114-638-22	OBWEGESER Weisheitszahn-Haken third molar retractor separador para muela del juicio	24,0cm; 9 4/8" 75 x 12 / 22 mm	
------------	---	-----------------------------------	--

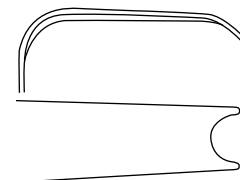

114-639-22	OBWEGESER spina nasalis-Haken nasal spine retractor separador para spina nasalis	24,0cm; 9 4/8" 45 x 10 / 23 mm	
------------	--	-----------------------------------	--

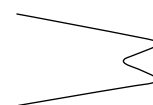

114

Art.Nr. Beschreibung | Description Size Spez.

OBWEGESER Unterkieferahle
maxillary awl
leznas maxilares



114-750-13

15,0cm; 5 7/8"

114-750-17

17,5cm; 6 7/8"

114-755-24

OBWEGESER Jochbogenahle
zygomatic arch awl
lezna para el arco cigomático

24,0cm; 9 4/8"

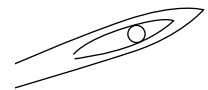

Osteotome
 Osteotomes
 Osteótomes



Art.Nr.	Beschreibung Description	Size	Spez.
	TESSIER	16,0cm; 6 2/8"	

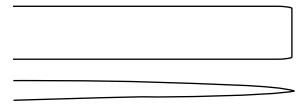

114-800-02	2,0 mm
114-800-03	3,0 mm
114-800-05	5,0 mm
114-800-07	7,0mm
114-800-10	10,0 mm
114-800-14	14,0 mm
114-800-16	16,0 mm
114-801-05	5,0 mm
114-801-07	7,0 mm
114-801-10	10,0 mm

Weitere Artikel
further items
más artículos

Art.Nr.	Beschreibung Description	Size	Spez.
Other items available but not illustrated			
	POLITZER ear specula		
111-010-03	Set with fig. 1-3		
111-011-01	fig. 1; 2,0mm		
111-011-02	fig. 2; 3,0mm		
111-011-03	fig. 3; 4,0mm		
111-011-04	fig. 4; 5,0mm		
	HARTMANN ear specula; black		
111-031-00	fig. 1; 2,0mm		
111-031-01	fig. 2; 3,0mm		
111-031-02	fig. 3; 4,0mm		
111-031-03	fig. 4; 5,0mm		
111-031-11	4,5mm		
111-031-12	5,5mm		
111-031-13	6,5mm		
111-031-14	7,5mm		
111-032-04	Set with fig. 0-3		
111-035-05	TOYNBEE ear specula; fig. 5; 7,5mm		
	GRUBER ear specula		
111-040-04	Set with fig. 1-4		
111-041-01	fig. 1; 4,5mm		
111-041-02	fig. 2; 5,5mm		
111-041-03	fig. 3; 6,5mm		
111-041-04	fig. 4; 7,0mm		
	BOUCHERON ear specula		
111-046-00	Set with fig. 1-4		
111-046-01	fig. 1; 3,5mm		
111-046-02	fig. 2; 4,5mm		
111-046-03	fig. 3; 5,5mm		
111-046-04	fig. 4; 6,5mm		
	FARRIOR ear specula; round		
111-050-33	3,3mm		
111-050-43	4,3mm		
111-050-48	4,8mm		
111-050-53	5,3mm		
111-050-58	5,8mm		
111-050-63	6,3mm		
111-050-67	6,7mm		
111-050-72	7,2mm		
111-050-77	7,7mm		

Weitere Artikel
further items
más artículos



Art.Nr.	Beschreibung Description	Size	Spez.
---------	----------------------------	------	-------

Other items available but not illustrated

	FARRIOR ear specula; oval		
111-052-30	3,0 x 4,0mm		
111-052-40	4,0 x 5,0mm		
111-052-45	4,5 x 5,5mm		
111-052-50	5,0 x 6,0mm		
111-052-55	5,5 x 6,5mm		
111-052-60	6,0 x 7,0mm		
111-052-65	6,5 x 7,5mm		
111-052-70	7,0 x 8,0mm		
111-052-75	7,5 x 8,5mm		
111-053-30	20°; 3,0 x 4,0mm		
111-053-40	20°; 4,0 x 5,0mm		
111-053-45	20°; 4,5 x 5,5mm		
111-053-50	20°; 5,0 x 6,0mm		
111-053-55	20°; 5,5 x 6,5mm		
111-053-60	20°; 6,0 x 7,0mm		
111-053-65	20°; 6,5 x 7,5mm		
111-053-70	20°; 7,0 x 8,0mm		
111-053-75	20°; 7,5 x 8,5mm		
111-054-30	35°; 3,0 x 4,0mm		
111-054-40	35°; 4,0 x 5,0mm		
111-054-45	35°; 4,5 x 5,5mm		
111-054-50	35°; 5,0 x 6,0mm		
111-054-55	35°; 5,5 x 6,5mm		
111-054-60	35°; 6,0 x 7,0mm		
111-054-65	35°; 6,5 x 7,5mm		
111-054-70	35°; 7,0 x 8,0mm		
111-054-75	35°; 7,5 x 8,5mm		
	BRUENINGS ear specula		
111-060-00	complete with 4 specula; suction head and rubbertube		
111-061-01	fig. 00; 2,0/4,0mm		
111-061-02	fig. 0; 3,0/4,8mm		
111-062-01	fig. 1; 4,0/6,0mm		
111-062-02	fig. 2; 5,0/7,0mm		
111-062-03	fig. 3; 6,5/8,5mm		
111-062-04	fig. 4; 8,5/10,5mm		
111-062-05	fig. 5; 10,5/12,5mm		
111-064-01	BRUENINGS suction head only		
111-065-00	rubbertube only		
	SIEGLE ear specula		
111-072-00	complete with 3 specula, air blower		
111-072-01	fig. 1; 5,0/6,0mm		
111-072-02	fig. 2; 6,0/7,0mm		
111-072-03	fig. 3; 7,0/8,0mm		

Weitere Artikel
further items
más artículos

Art.Nr.	Beschreibung Description	Size	Spez.
Other items available but not illustrated			
111-072-90	SIEGLE blower only		
111-115-00	LANGE-WILDE polypus snare; straight	16,0cm; 6,4"	
	snare wires		
111-130-02	box with 12 pcs.	0,2mm	
111-130-03	box with 12 pcs.	0,3mm	
111-132-01	box with 100 pcs.	0,20mm	
111-132-02	box with 100 pcs.	0,25mm	
111-132-03	box with 100 pcs.	0,30mm	
111-230-08	HARTMANN-NOYES ear forceps; serrated; shaft	8,5cm; 3,4"	
111-233-08	DUCKBILL ear forceps; serrated; shaft	8,5cm; 3,4)	
111-234-08	WEINGÄRTNER ear forceps; serrated; shaft	8,5cm; 3,4"	
111-256-08-CW	HARTMANN ear forceps; Clean-Wave; serrated; shaft	8,5cm; 3,4"	
	HARTMANN ear forceps		
111-256-16	jaw 1,6 x 8mm; shaft	16,0cm; 6,4"	
111-258-14	serrated; 1x2 teeth; shaft	14,0cm; 5,6"	
111-269-20	cup jaw curved up; Ø 2,0mm; shaft	8,5cm; 3,4"	
111-280-20	cup jaw curved up; Ø 2,0mm; shaft	8,5cm; 3,4"	
111-280-25	cup jaw curved up; Ø 2,5mm; shaft	8,5cm; 3,4"	
111-294-08	oval jaw; shaft	8,5cm; 3,4"	
111-298-08	trough-cutting; shaft	8,5cm; 3,4"	
111-310-08-CW	micro ear forceps; CleanWave alligator jaw; straight; 4,0 x 0,8mm; shaft	8,0cm; 3,2"	
	micro ear forceps; alligator jaw	8,0cm; 3,2"	
111-330-08	curved down; serrated; 4,5 x 0,8mm; shaft		
111-334-08	straight; 8,5 x 0,8mm; seshaft		
111-336-08	straight; 8,5 x 1,8mm; seshaft		
111-344-08-CW	WULLSTEIN; earforceps, fine; ovale 0,9mm, working length 8cm		
	micro ear cup forceps	8,0cm; 3,2"	
111-346-08	straight; 1,25 x 0,8mm; shaft; black		
111-360-08	curved down; 1,25 x 0,8mm		
111-378-08-CW	BELLUCCI; scissor; fine pattern; cutting length 8mm; working length 8cm		
111-382-08	BELLUCCI micro ear scissors; straight; blade 5,5mm; shaft	8,0cm; 3,2"	

Weitere Artikel
further items
más artículos



Art.Nr.	Beschreibung Description	Size	Spez.
Other items available but not illustrated			
111-410-08	WULLSTEIN ear forceps; tubing shaft alligator jaw; straight; 5 x 0,5mm	8,0cm; 3,2"	
111-411-08	alligator jaw; curved up; 4 x 0,5mm		
111-412-08	alligator jaw; straight; 7 x 0,5mm		
111-414-08	cup jaw; Ø 2,5mm; straight		
111-415-08	cup jaw; Ø 0,9mm; straight		
111-416-08	cup jaw oval; Ø 0,9 x 1,2mm; straight		
111-420-08	BELUCCI micro ear scissors; tubing shaft straight; blade 4mm	8,0cm; 3,2"	
111-421-08	curved right; blade 4mm		
111-422-08	TABB Crurotomie forceps; tubing shaft jaw 1 x 10mm; shaft Ø 1,5mm	8,0cm; 3,2"	
111-423-08	BELUCCI micro ear scissors; tubing shaft curved left; blade 4mm	8,0cm; 3,2"	
111-425-08	curved up; blade 4mm		
111-428-08	WULLSTEIN-BLAKESLEY ear forceps; tubing shaft cup jaw; oval; 2 x 5mm; fenestrated	8,0cm; 3,2"	
111-500-01	CITELLI punch; 1mm; shaft	6,0cm; 2,5"	
111-503-00	BUCK ear curette blunt; straight; fig. 000	16,5cm; 6,6"	
111-504-00	blunt; straight; fig. 00		
111-505-00	blunt; straight; fig. 0		
111-505-01	blunt; straight; fig. 1		
111-505-02	blunt; straight; fig. 2		
111-505-03	blunt; straight; fig. 3		
111-505-04	blunt; straight; fig. 4		
111-505-05	blunt; straight; fig. 5		
111-508-02	blunt; straight; fig. 2		
111-512-05	blunt; curved; fig. 5		
111-513-00	sharp; straight; fig. 000		
111-514-00	sharp; straight; fig. 00		
111-515-00	sharp; straight; fig. 0		
111-515-01	sharp; straight; fig. 1		
111-515-02	sharp; straight; fig. 2		
111-515-03	sharp; straight; fig. 3		
111-515-04	sharp; straight; fig. 4		
111-515-05	sharp; straight; fig. 5		

Weitere Artikel
further items
más artículos

Art.Nr.	Beschreibung Description	Size	Spez.
Other items available but not illustrated			
111-542-01	SNELLEN ear loop serrated; fig. 1	16,5cm; 6,6"	
111-542-02	serrated; fig. 2		
111-590-00	ZAUFAL-JANSEN ear hook	15,0cm; 6"	
111-615-16	POLITZER tympanum needle; angled; needle horizontally	16,5cm; 6,6"	
111-617-18	LUCAE tympanum needle; straight	18,0cm; 7,2"	
111-620-17	POLITZER tympanum needle; 90° variable	17,0cm; 6,8"	
111-622-16	POLITZER knife; straight	16,0cm; 6,4"	
111-624-00	SPRAGUE ear instrument set; complete with 6 inserts		
111-624-01	SPRAGUE tympanum needle; insert only		
111-624-02	SPRAGUE knife; insert only		
111-624-03	SPRAGUE ear scoop; insert only		
111-624-04	SPRAGUE ear loop; insert only		
111-624-05	SPRAGUE ear hook; insert only		
111-624-06	SPRAGUE button probe; insert only		
111-636-03	BARBARA ear needle; 25°; 0,3mm	16,0cm; 6,4"	
111-637-08	SHAMBAUGH ear needle 45°; 0,8mm	16,0cm; 6,4"	
111-638-08	90°; 0,8mm		
111-644-03	ear needle angled; 25° upwards; 0,3mm	16,0cm; 6,4"	
111-644-06	angled; 25° upwards; 0,6mm		
111-644-10	angled; 25° upwards; 1,0mm		
111-645-03	angled; 25° downwards; 0,3mm		
111-645-06	angled; 25° downwards; 0,6mm		
111-645-10	angled; 25° downwards; 1,0mm		
111-646-03	angled; 45° upwards; 0,3mm		
111-646-06	angled; 45° upwards; 0,6mm		
111-646-10	angled; 45° upwards; 1,0mm		
111-647-03	angled; 45° downwards; 0,3mm		
111-647-06	angled; 45° downwards; 0,6mm		
111-647-10	angled; 45° downwards; 1,0mm		
111-649-10	angled; 90° downwards; 1,0mm		

Weitere Artikel
further items
más artículos



Art.Nr.	Beschreibung Description	Size	Spez.
Other items available but not illustrated			
111-668-16	PLESTER knife straight	16,0cm; 6,4"	
111-669-16	curved		
111-670-16	Ø 2,4mm x 3,0mm		
111-673-16	SCHUKNECHT knife curved; cutting horizontal	16,0cm; 6,4"	
111-674-16	curved; cutting vertical		
111-689-15	ROSEN periosteal elevator angled; 1,5mm	16,0cm; 6,4"	
111-689-25	angled; 2,5mm		
111-690-01	fig. 1		
111-690-02	fig. 2		
111-690-03	fig. 3		
111-690-04	fig. 4		
111-690-05	fig. 5		
111-690-06	fig. 6		
111-691-16	PLESTER applying instrument	16,0cm; 6,4"	
111-704-16	SHEA curette oval; 1,5 x 2,5mm		
111-705-16	angled; oval; 1,5 x 2,5mm		
111-718-01	ZÖLLNER ear needle straight		
111-718-02	45° downwards; 0,5mm		
111-718-03	45° downwards; 1,0mm		
111-718-04	45° upwards; 0,5mm		
111-718-05	45° upwards; 1,0mm		
111-718-06	90° upwards; 0,5mm		
111-718-07	90° downwards; 0,5mm		
111-718-08	ZÖLLNER ear hook upwards; 1,0mm		
111-718-09	downwards; 1,0mm		
111-718-10	ZÖLLNER roundknife 90° upwards		
111-718-11	90° downwards		
111-718-12	ZÖLLNER ear knife upwards		
111-718-13	downwards		
111-718-14	cutting to the right		
111-718-15	cutting to the left		

Weitere Artikel
further items
más artículos

Art.Nr.	Beschreibung Description	Size	Spez.
Other items available but not illustrated			
111-718-16	POLITZER ear specula right		
111-718-17	left		
111-718-18	ZÖLLNER applying instrument		
111-720-01	SCHUHKNECHT ear hook sharp	16,5cm; 6,6"	
111-720-02	blunt		
111-721-02	SCHUHKNECHT ear needle angled; 45°; downwards; 0,2mm	16,5cm; 6,6"	
111-721-04	angled; 45°; downwards; 0,4mm		
111-721-06	angled; 45°; downwards; 0,6mm		
111-721-08	angled; 45°; downwards; 0,8mm		
111-721-10	angled; 45°; downwards; 1,0mm		
111-721-12	angled; 45°; upwards; 0,2mm		
111-721-14	angled; 45°; upwards; 0,4mm		
111-721-16	angled; 45°; upwards; 0,6mm		
111-721-18	angled; 45°; upwards; 0,8mm		
111-721-20	angled; 45°; upwards; 1,0mm		
111-721-22	angled; 45°; right; 0,2mm		
111-721-24	angled; 45°; right; 0,4mm		
111-721-26	angled; 45°; right; 0,6mm		
111-721-28	angled; 45°; right; 0,8mm		
111-721-30	angled; 45°; right; 1,0mm		
111-721-32	angled; 45°; left; 0,2mm		
111-721-34	angled; 45°; left; 0,4mm		
111-721-36	angled; 45°; left; 0,6mm		
111-721-38	angled; 45°; left; 0,8mm		
111-721-40	angled; 45°; left; 1,0mm		
111-723-02	angled; 90°; downwards; 0,2mm		
111-723-04	angled; 90°; downwards; 0,4mm		
111-723-06	angled; 90°; downwards; 0,6mm		
111-723-08	angled; 90°; downwards; 0,8mm		
111-723-10	angled; 90°; downwards; 1,0mm		
111-723-12	angled; 90°; upwards; 0,2mm		
111-723-14	angled; 90°; upwards; 0,4mm		
111-723-16	angled; 90°; upwards; 0,6mm		
111-723-18	angled; 90°; upwards; 0,8mm		
111-723-20	angled; 90°; upwards; 1,0mm		
111-723-22	angled; 90°; right; 0,2mm		
111-723-24	angled; 90°; right; 0,4mm		
111-723-26	angled; 90°; right; 0,6mm		
111-723-28	angled; 90°; right; 0,8mm		
111-723-30	angled; 90°; right; 1,0mm		
111-723-32	angled; 90°; left; 0,2mm		
111-723-34	angled; 90°; left; 0,4mm		

Weitere Artikel
further items
más artículos



Art.Nr.	Beschreibung Description	Size	Spez.
Other items available but not illustrated			
111-723-36	SCHUHKNECHT ear needle angled; 90°; left; 0,6mm	16,5cm; 6,6"	
111-723-38	angled; 90°; left; 0,8mm		
111-723-40	angled; 90°; left; 1,0mm		
111-760-01	WULLSTEIN periosteal elevator straight; 2,2mm	16,0cm; 6,4"	
111-760-02	curved; 3,2mm		
111-762-03	LEMPERT periosteal elevator; straight; 3mm	16,0cm; 6,4"	
111-763-16	SHAMBOUGH-DERLACKI elevator; curved	16,5cm; 6,6"	
111-764-02	LEMPERT elevator curved; 2,0mm	17,0cm; 6,8"	
111-764-03	curved; 3,0mm	17,0cm; 6,8"	
111-764-04	curved; 4,0mm	17,0cm; 6,8"	
111-764-05	curved; 5,0mm	17,0cm; 6,8"	
111-769-02	curved; 2,0mm	16,0cm; 6,4"	
111-769-03	curved; 3,0mm	16,0cm; 6,4"	
111-822-13	BARON suction tube; Ø 1,3mm; WL: 75mm		
111-825-12	ZÖLLNER Micro suction insert; 18 Gauge (1,2mm); 40mm		
111-828-08	ROSEN (HOUSE) ear cannula; curved; Luer-Lock; 21 Gauge (0,8mm)		
111-830-01	WULLSTEIN tubing connection piece		
111-831-15	WULLSTEIN suction tube Ø 1,5mm; silver; malleable	16,0cm; 6,4"	
111-831-20	Ø 2,0mm; silver; malleable		
111-831-90	Luer-Lock tubing connection piece; for Rosen and Wullstein suction tubes		
111-832-15	WULLSTEIN suction tube; Ø 1,5mm; silver; malleable	14,0cm; 5,6"	
111-836-00	BELLUCCI suction tube complete; with 3 Tips	15,5cm; 6,2"	
111-836-04	BELLUCCI suction tube insert Ø 0,4mm; 26 gauge		
111-836-05	insert Ø 0,5mm; 24 gauge		
111-836-07	insert Ø 0,7mm; 22 gauge		
111-836-09	insert Ø 0,9mm; 20 gauge		
111-836-12	insert Ø 1,2mm; 18 gauge		
111-836-15	BELLUCCI suction tube only	15,5cm; 6,2"	

Weitere Artikel
further items
más artículos

Art.Nr.	Beschreibung Description	Size	Spez.
Other items available but not illustrated			
111-836-99	BELLUCCI suction tube; stylet only		
111-838-20	LEMPERT suction tube Ø 2,0mm	20,0cm; 8"	
111-838-30	Ø 3,0mm		
111-848-00	HARTMANN ear catheter fig. 0	14,0cm; 5,6"	
111-848-04	fig. 4		
111-848-05	fig. 5		
111-855-05	HARTMANN tuning fork set set with 5 tuning forks		
111-855-06	set with 6 tuning forks		
111-855-08	set with 8 tuning forks		
111-856-01	tuning fork Aluminium C 64		
111-856-07	C 4096		
111-857-05	Aluminium tuning fork set; set with 5 tuning forks		
111-862-00	tuning fork; A1 440		
111-880-35	POLITZER catether tip		
111-884-00	BARANY noise apparatus with ear cone		
111-885-00	with ear piece		
111-888-08	ear syringe complete 75ml		
111-888-15	150ml		
111-889-15	3-ring ear syringe complete; 150ml; Luer-Lock; glass		
112-010-01	DUPLAY nasal specula Fig. 1; 47mm		
112-010-02	Fig. 2; 47mm		
112-010-03	Fig. 3; 47mm		
112-022-01	HARTMANN nasal specula Fig. 1	15,0cm; 6"	
112-022-02	Fig. 2		
112-022-03	Fig. 3		
112-030-02	TIECK-HALLE nasal specula; Fig. 2	13,5cm; 5,4"	

Weitere Artikel
further items
más artículos



Art.Nr.	Beschreibung Description	Size	Spez.
Other items available but not illustrated			
112-035-02	BECKMANN nasal specula; Fig. 2	15,0cm; 6"	
112-061-01	COTTLE nasal specula 35mm; with screw	15,0cm; 6"	
112-061-02	50mm; with screw		
112-061-03	75mm; with screw		
112-061-04	90mm; with screw		
112-064-04	THUDICHUM nasal specula Fig. 4	6,5cm; 2,6"	
112-064-05	Fig. 5		
112-064-06	Fig. 6		
112-064-07	Fig. 7		
112-065-01	VOLTOLINI(DUPLAY) nasal specula Fig. 1		
112-065-02	Fig. 2		
112-065-03	Fig. 3		
112-080-01	CUSHING-LANDOLT spec. for hypophys. 70x15mm		
112-080-02	90x15mm		
112-080-03	CUSHING LANDOLT specula; 110x15mm		
112-081-21	LANDOLT spreader for specula		
112-114-00	LANGE-WILDE nasal snare; with 1 tip	24,0cm; 9,5"	
112-130-11	Wire Loops only 0,25 mm x 10cm; for nasal polypus snares; 1 dozen; pack / 12 pieces		
112-130-13	0,35 mm x 10cm; for nasal polypus snares; 1 dozen; pack / 12 pieces		
112-130-21	0,25 mm x 10cm; for nasal polypus snares; pack / 100 pieces		
112-130-22	0,30 mm x 10cm; for nasal polypus snares; pack / 100 pieces		
112-130-23	0,35 mm x 10cm; for nasal polypus snares; pack / 100 pieces		
112-160-16	HARTMANN nasal polypus forceps; angled; serrated	16,0cm; 6,4"	
112-161-18	HEYMANN-KNIGHT nasal polypus forceps; angled; serrated	18,0cm; 7,2"	
112-163-17	KILLIAN nasal polypus forceps; angled; serrated	17,0cm; 6,8"	
112-164-02	WESTMACOTT nasal polypus forceps; Fig. 2	20,0cm; 8"	
112-165-19	HARTMANN nasal polypus forceps; gerieft	19,0cm; 7,6"	
112-170-14	NOYES nasal dressing forceps; serrated	14,0cm; 5,6"	

Weitere Artikel
further items
más artículos

Art.Nr.	Beschreibung Description	Size	Spez.
Other items available but not illustrated			
112-200-01	JOSEPH rhinoplastic knives double cutting edges	16,5cm; 6,6"	
112-201-02	Fig. 2; sharp curved	14,5cm; 5,7"	
112-205-13	MASING rhinoplastic knives; curved blade	13,0cm; 5"	
112-207-15	COTTLE knives; rounded edges	15,0cm; 6"	
112-210-02	FREER "E" septum knives; straight	15,0cm; 6"	
112-210-03	FREER septum knives; straight	15,0cm; 6"	
112-215-00	BRUENINGS knives; straight	16,0cm; 6,4"	
112-215-16	spare blade for KO 315/00	16,5cm; 6,6"	
112-216-16	JOSEPH knives; angled	16,5cm; 6,6"	
112-217-16	MALTZ knives; malleable	16,5cm; 6,6"	
112-220-12	TÖNNIS dura knives straight	12,5cm; 5"	
112-220-20	straight	20,5cm; 8,2"	
112-251-22	BALLENGER-HAJEK Septum Elevator; sharp/blunt	20,0cm; 8"	
112-258-21	PIERCE septum elevator; double ended	21,0cm; 8,4"	
112-268-18	MALTZ nasal rasps; straight	18,0cm; 7,2"	
112-276-18	CONVERSE nasal rasps; double ended	18,5cm; 7,5"	
112-277-02	FOMON nasal rasps; Fig. 2; coarse	21,0cm; 8,4"	
112-279-21	MASING nasal rasps; double ended	21,0cm; 8,4"	
112-290-01	LEWIS rasp with TC Fig. 1; pushing cut	18,0cm; 7,2"	
112-290-02	Fig. 2; drawing cut		
112-292-21	COTTLE rasp with TC; straight	21,0cm; 8,4"	
112-294-02	rasp fig. 2; diamond dusted; flat; straight	19,0cm; 7,6"	
112-294-03	fig. 3; diamond dusted; flat; curved		
112-294-04	fig. 4; diamond dusted; convex; straight		
112-294-05	fig. 5; diamond dusted; convex; curved		
112-294-06	fig. 6; diamond dusted; concav; straight		

Weitere Artikel
further items
más artículos



Art.Nr.	Beschreibung Description	Size	Spez.
Other items available but not illustrated			
112-294-07	fig. 7; diamond dusted; concav; curved		
112-296-04	FOMON rasp with TC; double ended; 4-sided		
112-301-16	COTTLE dura and skin hook; sharp; retrograde curved 180°	16,0cm; 6,4"	
112-309-00	COTTLE(MILLARD) delicate hook; 2-pronged		
112-310-10	KILNER delicate hook; 2-pronged	10,0cm; 4"	
112-313-12	CONVERSE retractor; double ended	12,0cm; 4,8"	
112-314-20	MASING retractor	20,0cm; 8"	
YANKAUER septum needles			
112-340-01	Fig. 1		
112-340-02	Fig. 2		
112-340-03	Fig. 3		
112-340-04	Fig. 4		
112-340-05	Fig. 5		
112-340-06	Fig. 6		
112-340-07	Fig. 7		
112-340-08	Fig. 8		
112-340-09	Fig. 9		
112-508-10	COTTLE osteotome; straight; 10,0mm	18,0cm; 7,2"	
112-534-02	WALTER osteotome; straight; 2,0mm	19,0cm; 7,6"	
SHEEHAN osteotome			
112-535-02	straight; 2,0mm	17,0cm; 6,7"	
112-535-03	straight; 3,0mm		
112-535-04	straight; 4,0mm		
112-535-05	straight; 5,0mm		
112-535-06	straight; 6,0mm		
112-535-07	straight; 7,0mm		
112-535-08	straight; 8,0mm		
112-535-10	straight; 10,0mm		
112-535-12	straight; 12,0mm		
SHEEHAN gouge			
112-535-52	straight; 2,0mm	16,0cm; 6,4"	
112-535-53	straight; 3,0mm		
112-535-54	straight; 4,0mm		
112-535-56	straight; 6,0mm		

112

Weitere Artikel
further items
más artículos

Art.Nr.	Beschreibung Description	Size	Spez.
Other items available but not illustrated			
112-541-00	MASING osteotome straight	17,5cm; 6,9"	
112-541-01	curved left		
112-541-02	curved right		
112-544-00	CONVERSE chisel Fig. 0	19,0cm; 7,5"	
112-544-01	Fig. 1		
112-544-02	Fig. 2		
112-602-00	BARNHILL adenoid currettes Fig. 0	22,0cm; 8,8"	
112-602-01	Fig. 1		
112-602-02	Fig. 2		
112-602-03	Fig. 3		
112-602-04	Fig. 4		
112-605-01	ST.CLAIR-THOMPSON adenoid currettes Fig. 1	21,0cm; 8,3"	
112-605-02	Fig. 2		
112-605-03	Fig. 3		
112-605-04	Fig. 4		
112-610-01	LA FORCE adenotomes Fig. 1; unperforated	25,0cm; 10"	
112-610-02	Fig. 2; unperforated		
112-610-03	Fig. 3; unperforated		
112-611-01	LA FORCE spare blade Fig. 1	unperforated	
112-611-02	Fig. 2		
112-611-03	Fig. 3		
112-612-01	LA FORCE adenotomes Fig. 1; perforated	25,0cm; 10"	
112-612-02	Fig. 2; perforated		
112-612-03	Fig. 3; perforated		
112-613-01	LA FORCE spare blade Fig. 1	perforated	
112-613-02	Fig. 2		
112-613-03	Fig. 3		
112-652-22	COTTLE-WALSHAM septum straight. forceps; straight	22,0cm; 8,8"	

Weitere Artikel
further items
más artículos



Art.Nr.	Beschreibung Description	Size	Spez.
Other items available but not illustrated			
112-654-70	KRESSNER septum forceps 4x70mm	20,0cm; 8"	
112-654-75	5x75mm		
112-655-00	bone and cartilage guide; complete; consisting of: 112-655-01 + 112-655-02		
112-657-18	BOIES nasal fracture elevator; oval; blunt edges	18,0cm; 7,2"	
112-658-20	GOLDMANN septum elevator; round; (displacer)		
WEIL-BLAKESLEY sinuscopy forceps			
113-070-01	2,5mm; 0"		
113-070-02	3,0mm; 0"		
113-070-03	3,5mm; 0"		
113-070-06	2,5mm; 45"		
113-070-07	3,0mm; 45"		
113-070-08	3,5mm; 45"		
113-070-11	2,5mm; 0"		
113-070-12	3,0mm; 0"		
113-070-13	3,5mm; 0"		
113-070-16	2,5mm; 45"		
113-070-17	3,0mm; 45"		
113-070-18	3,5mm; 45"		
113-070-21	2,5mm; 90"		
113-070-22	3,0mm; 90"		
113-070-23	3,5mm; 90"		
113-070-31	2,5mm; 90"		
113-070-32	3,0mm; 90"		
113-070-33	3,5mm; 90"		
113-070-40	right; 2,5mm		
113-070-41	right; 3,0mm		
113-070-42	right; 3,5mm		
113-070-45	left; 2,5mm		
113-070-46	left; 3,0mm		
113-070-47	left; 3,5mm		
113-070-50	right; 2,5mm		
113-070-51	right; 3,0mm		
113-070-52	right; 3,5mm		
113-070-55	left; 2,5mm		
113-070-56	left; 3,0mm		
113-070-57	left; 3,5mm		
113-071-01	2,5mm; 0"		
113-071-02	3,0mm; 0"		
113-071-03	3,5mm; 0"		
113-071-04	4,0mm; 0"		
113-071-06	2,5mm; 45"		
113-071-07	3,0mm; 45"		
113-071-08	3,5mm; 45"		

Weitere Artikel
further items
más artículos

Art.Nr.	Beschreibung Description	Size	Spez.
Other items available but not illustrated			
113-071-09	4,0mm; 45"		
113-071-11	2,5mm; 0"		
113-071-12	3,0mm; 0"		
113-071-13	3,5mm; 0"		
113-071-14	4,0mm; 0"		
113-071-16	2,5mm; 45"		
113-071-17	3,0mm; 45"		
113-071-18	3,5mm; 45"		
113-071-19	4,0mm; 45"		
113-071-27	TAKAHASHI forceps; A 4,0 x 10,0mm		
113-071-28	STRUYCKEN forceps	A 1,0 x 10,0mm	
113-071-37	TAKAHASHI forceps	B 4,0 x 10,0mm	
113-071-38	STRUYCKEN forceps	B 1,0 x 10,0mm	
Sinuscopy forceps			
113-075-01	1,5 x 6,0mm		
113-075-02	2,0 x 6,0mm		
113-075-03	2,5 x 8,0mm		
113-075-11	1,5 x 6,0mm		
113-075-12	2,0 x 6,0mm		
113-075-13	2,5 x 8,0mm		
113-075-21	1,5 x 6,0mm		
113-075-22	2,0 x 6,0mm		
113-075-23	2,5 x 8,0mm		
Punch			
113-076-01	2,5 x 6,0mm; 0"		
113-076-02	2,5 x 6,0mm; 30"		
113-076-03	2,5 x 6,0mm; 45"		
113-076-04	2,5 x 6,0mm; 60"		
113-076-05	2,5 x 6,0mm; 70"		
Sinuscopy scissors			
113-080-01	smooth	12,0cm; 4,8"	
113-080-02	smooth; curved to the right side		
113-080-03	smooth; curved to the left side		
113-080-11	straight; serrated		
113-080-12	curved right side; serrated		
113-080-13	curved left side; serrated		
Micro sinuscopy forceps			
113-080-21		12,0cm; 4,8"	
113-080-22			

Weitere Artikel
further items
más artículos



Art.Nr.	Beschreibung Description	Size	Spez.
Other items available but not illustrated			
113-080-23 113-080-31 113-080-32 113-080-33			
	Biopsy forceps	12,0cm; 4,8"	
113-085-01	70"		
113-085-02	90"		
113-085-03	110"		
113-085-11	70"		
113-085-12	90"		
113-085-13	110"		
113-086-01	STAMMBERGER Sinuscopy forceps; 12cm shaft 65° curved up; Ø 2,5mm; spoon horizontal cutting; Ø 3mm		
113-086-02	shaft 65° curved up; Ø 2,5mm; spoon vertical cutting; Ø 3mm		
113-095-15	Biopsy forceps; with cup jaws; oval oval; 4 x 2mm, double action; ring handle	15,5cm; 6,2"	
113-104-12	WATSON-WILLIAMS nasal forceps; curved up		
	WATSON-WILLIAMS nasal cutting forceps	12,0cm; 4,8"	
113-105-02	Fig. 2; straight		
113-105-03	Fig. 3; straight		
113-107-01	Nasal biopsy forceps with tapered spoon forceps open to right; mall. distal shaft	15,0cm; 6"	
113-107-02	with tapered spoon forceps open to left; mall. distal shaft		
113-108-01	JATHO nasal punch forceps; curved up; horizontal opening	22,5cm; 9"	
113-111-01-CW	BLAKESLEY; Nasal forceps; straight Clean Wave; width 3,5mm; length 11cm		
	GRUENWALD Nasal cutting forceps		
113-112-01	Fig. 1		
113-112-02	Fig. 2		
113-112-03	Fig. 3		
113-113-12	curved up		
	SCHMEDEN nasal forceps		
113-114-01	Fig. 1		
113-114-03	Fig. 3		
	MYLES nasal forceps		
113-116-01	Fig. 1		
113-116-02	Fig. 2		

Weitere Artikel
further items
más artículos

Art.Nr.	Beschreibung Description	Size	Spez.
Other items available but not illustrated			
113-116-03	Fig. 3		
113-116-04	Fig. 4		
113-118-25	TAKAHASHI nasal forceps straight; 2,5 x 10mm	14,0cm; 5,6"	
113-119-25	70° up; 2,5 x 10mm	14,0cm; 5,6"	
113-120-25	straight; 2,5 x 10mm	12,0cm; 4,8"	
113-120-40	4 x 10mm	12,0cm; 4,8"	
113-121-40	upwards angled; 4 x 10mm	12,0cm; 4,8"	
113-122-12	STRUYCKEN nasal forceps Fig. 1		
113-123-12	Fig. 3		
113-128-30	TAKAHASHI nasal forceps; straight; 3,0 x 10mm; with suction tube	12,0cm; 4,8"	
113-137-01	LUC septum forceps		
113-137-02			
113-140-01	HEYMANN septum forceps		
113-140-02			
113-140-03	sharp	18,0cm; 7"	
113-174-16	HAJEK-KOFLER punch; shaft 360° rotatable	jaw 3,0mm	
113-185-20	HAJEK-CLAUS sphenoid punch		
113-200-00	WEIL-BLAKESLEY nasal forceps; Fig.0; 2,5 x 3,0mm	12,0cm; 4,8"	
113-200-01-CW	BLAKESLEY; Nasal forceps; straight Fig. 1; working length 11cm; similar to K.ST.: 456001		
113-201-00	WEIL-BLAKESLEY nasal forceps Fig. 0, 45° curved up; 2,5 x 3,0mm	12,0cm; 4,8"	
113-201-05	Fig. 5; 45° curved up; 6,0 x 14mm		
113-205-01	Fig. 1; 45° curved down; 2,5 x 5,0mm		
113-210-00	Fig. 0; straight; through cut; 2,5mm		
113-210-01	Fig. 1; straight; through cut; 3,0mm		
113-211-00	Fig. 0; up-angled; through cut		
113-211-01	Fig. 1; up-angled; through cut		
113-220-00	BLAKESLEY-LEWIS nasal septum forceps straight; 9,0mm	12,0cm; 4,8"	
113-220-01	right; 9,0mm		
113-220-03	left; 9,0mm		

Weitere Artikel
further items
más artículos



Art.Nr.	Beschreibung Description	Size	Spez.
Other items available but not illustrated			
113-240-12	FERRIS-SMITH septum forceps; sequestrum forceps	12,0cm; 4,8"	
	OSTRUM antrum punch	10,0cm; 4"	
113-370-15	rotatable; jaw 1,5mm bite; backward cut.		
113-370-25	rotatable; jaw 2,5mm bite; backward cut.		
113-372-15	upside; jaw 1,5mm bite; backward cut.		
113-373-15	right side; 1,5mm bite; backward cut.		
113-375-15	left side; 1,5mm bite; backward cut.		
113-382-25	Antrum punch; 2,5 x 6,5mm; upside backward cutting	10,0cm; 4"	
	Nasal scissors; ring handle	13,5cm; 5,4"	
113-390-13	straight; blade 14mm; 1 blade toothed		
113-391-13	right curved; blade 14mm; 1 blade toothed		
113-393-13	left curved; blade 14mm; 1 blade toothed		
113-625-90	atrium scoop		
	LANGENBECK finger protector		
114-115-01	fig. 1		
114-115-03	fig. 3		
114-120-00	PITHA oral wedges		
	SEEMANN-SEIFFERT mouth gags		
114-247-09		9,0cm; 3,6"	
114-247-11		11,0cm; 4,4"	
114-247-13		13,0cm; 5,2"	
114-247-15		15,0cm; 6"	
	WHITEHEAD mouth gags		
114-248-09	without tongue depressor	9,0cm; 3,6"	
114-248-11	without tongue depressor	11,0cm; 4,4"	
114-248-13	without tongue depressor	13,0cm; 5,2"	
114-248-15	without tongue depressor	15,0cm; 6"	
114-248-99	spring for WHITEHEAD mouth gags		
	WHITEHEAD mouth gags		
114-249-09	with tongue depressor	9,0cm; 3,6"	
114-249-11	with tongue depressor	11,0cm; 4,4"	
114-249-13	with tongue depressor	13,0cm; 5,2"	
114-249-15	with tongue depressor	15,0cm; 6"	
114-261-04	gags only for DINGMANN		
114-264-07	DAVIS-BOYLE mouth gags; frame only; for children		

Weitere Artikel
further items
más artículos

Art.Nr.	Beschreibung Description	Size	Spez.
Other items available but not illustrated			
114-264-08	replacing piece, silicon; for DAVIS-BOYLE mouth gags		
114-264-99	DAVIS-BOYLE silicon protection		
	MOD.WÜRZBURG tongue depressor		
114-268-01	66x28mm		
114-268-02	75x32mm		
114-268-03	83x34mm		
114-268-04	93x37mm		
114-268-05	100x38mm		
	RUSSEL DAVIS tongue depressor		
114-269-01	with groove holding endotracheal tube; 29x67mm		
114-269-02	with groove holding endotracheal tube; 33x75mm		
114-269-03	with groove holding endotracheal tube; 38x85mm		
114-269-04	with groove holding endotracheal tube; 40x92mm		
114-269-05	with groove holding endotracheal tube; 46x100mm		
	RUSSEL DAVIS tongue depressor;narrow mod		
114-269-06	with groove holding endotracheal tube; 18x55mm		
114-269-07	with groove holding endotracheal tube; 22x67mm		
114-269-08	with groove holding endotracheal tube; 25x75mm		
114-272-00	KILNER-DOUGHTY chest support; for mouth gags		
114-282-01	mouth gags; frame only; for adults		
	STERNBERG lip retractor		
114-405-12	double	12,0cm; 4,8"	
114-405-16	double	16,0cm; 6,4"	
114-438-19	MORITZ-SCHMIDT tongue depressor	19,0cm; 7,6"	
114-442-19	cheek and lip retractors	19,0cm; 7,6"	
114-444-14	tongue depressor; standard "S"	14,5cm; 5,8"	
114-446-15	KROENIG tongue depressor	15,0cm; 6"	
114-448-17	MAYO tongue depressor	17,0cm; 6,8"	
114-450-00	ERICH arch bars; roll/ 1 meter		
114-461-16	FRENZEL tongue depressor	16,5cm; 6,6"	
114-462-18	tongue depressor; 23mm	18,0cm; 7,2"	

Weitere Artikel
further items
más artículos



Art.Nr.	Beschreibung Description	Size	Spez.
Other items available but not illustrated			
114-575-01	OBWEGESER; elevator; double ended; blunt / blunt wide 6mm; length	21cm; 8,4"	
114-575-02	OBVWEGESER, raspatorium; 6mm	21,0cm; 8,4"	
114-802-18	TESSIER Osteotom; straight; 18,0mm	16,0cm; 6,4"	



Alphabetisches Verzeichnis

A

Ahle, Jochbogen-, OBWEGESER	114.75
aluminium Stimmgabel	111.33
Antrumkürette, COAKLEY	112.30
Antrumkürette, FAULKNER	112.30
Antrumkürette, SEWALL	112.30
Antrumstanze	113.50
Antrumstanze, KERRISON	112.2
ASCH, Septumrichtzange	112.39
AUFRICHT (WALTER), Nasenhaken	112.29
AUFRICHT, Nasenhaken	112.29
AUFRICHT, Nasenraspel	112.20

B

BALLENGER, Hohlmeißel	112.32
BALLENGER, Schwingmesser	112.11, 112.12
BARBARA, Mikro-Ohrhäkchen	111.24
BARBARA, Mikro-Ohrnadel	111.24, 111.25
BARTH, Ohrkürette	111.20
BAUER, Osteotom	114.67
BECKMANN, Nasenspekula	112.3
BECKMANN, Ringmesser	112.37, 112.38
BELLUCCI, Mikro-Ohrschere	111.15
BEYER, Ohr-Knochenstanze	111.17
BILLEAU, Fremdkörperinstrument	111.21
BISHOP, Lippen- und Wangenhalter	114.59
BRÜNINGS, Septumzange	113.45
BRÜNINGS, Zungenspatel	114.61
BUCK, Fremdkörperhebel	111.5
BUCK, Ohrkürette	111.19

C

CINELLI, Osteotom	112.35
CITELLI, Ohr-Knochenstanze	111.17
COAKLEY, Antrumkürette	112.30
COLLIN, Zungenzange	114.62
Columellapinzette, COTTLE	112.39
CONVERSE, Rhinoplastik-Messer	112.10
COTTLE, Columellapinzette	112.39
COTTLE, Führungshilfe	112.41
COTTLE, Griff	112.41
COTTLE, Hautfasspinzette	112.39
COTTLE, Knorpelquetsche	112.41
COTTLE, Nasenflügelhäkchen	112.26
COTTLE, Nasenhaken	112.27, 112.28
COTTLE, Nasenraspel	112.20
COTTLE, Nasenspekula	112.5
COTTLE, Osteotom	112.33, 112.34
COTTLE, Rhinoplastik-Messer	112.10
COTTLE, Septumelevator	112.15
COTTLE-NEIVERT, Nasenhaken	112.28

D

DAVIS-BOYLE, Mundsperrerr	114.57
DAVIS-BOYLE, Zungendrucker	114.57
DAY, Ohrhäkchen	111.22

DENHART, Mundsperrerr	114.53
DIETER, Hammerkopfzängchen	111.16
DINGMANN, Mundsperrerr	114.56
DINGMANN, Zungendrucker	114.56
Dissektor, Mikro-, FISCH	111.28
DOYEN, Zungenspatel	114.61
Drahtbiegezüngchen, MCGEE	111.14
Drücker, Zungen-, DAVIS-BOYLE	114.57
Drücker, Zungen-, DINGMANN	114.56
Drücker, Zungen-, HARTMANN	114.60
Drücker, Zungen-, KILNER-DOUGHTY	114.55
Drücker, Zungen-, MCIVOR	114.58
Drücker, Zungen-, TOBOLD	114.60
Drücker, Zungen-, WIEDER	114.60

E

Einsteckkonus, POLITZER	111.35
Elevator, Septum-, BALLENGER	112.12
Elevator, Septum-, COTTLE	112.15
Elevator, Septum-, FREER	112.13
Elevator, Septum-, FREER	112.13, 112.14
Elevator, Septum-, HALLE	112.13
Elevator, Septum-, HOWARTH	112.16
Elevator, Septum-, JOSEPH	112.13
Elevator, Septum-, JOSEPH-MASING	112.12
Elevator, Septum-, KILLIAN	112.16, 112.17
Elevator, Septum-, MASING	112.16
Elevator, Septum-, MCKENTY	112.12, 112.15
Elevator, Septum-, PENNINGTON	112.17
Elevatorium, Zygoma-, GILLIES	114.63
EPKER, Osteotom	114.68
EPKER-BAUER, Osteotom	114.67
Ersatzflasche, KABIERSKE	111.36

F

FAULKNER, Antrumkürette	112.30
Fingerschutz, LANGENBECK	114.51
FISCH, Mikro-Dissektor	111.28
FOMON, Meißel	112.35
FOMON, Nasenflügelhäkchen	112.26
FOMON, Nasenraspel	112.22
FOMON, Rhinoplastik-Messer	112.9
FOMON, Nasenraspel	112.24
FREER, Hohlmeißel	112.32
FREER, Meißel	112.31
FREER, Mukosamesser	112.10
FREER, Septumelevator	112.13, 112.14
Fremdkörperhebel, BUCK	111.5
Fremdkörperhebel, QUIRE	111.5
Fremdkörperinstrument, BILLEAU	111.21
Führungshilfe, COTTLE	112.41

G

GALLAHER, Nasenraspel	112.21
Gaumenplatte, KILNER-DOUGHTY	114.55
Gewindeansatz	111.38

Alphabetisches Verzeichnis

GILLIES, Zygoma-Elevatorium	114.63
GRAIG, Septumzange	113.44
GRAIG-DOMNICK, Septumzange.....	113.45
Griff, COTTLE	112.41
GROSS, Ohrlöffel	111.21
Gummibirne, POLITZER.....	111.35
Gummipolster, YOUNG	114.62

H

HAJEK-KOFLER, Nasenzange	113.47
Häkchen, Nasenflügel-, COTTLE	112.26
Häkchen, Nasenflügel-, FOMON.....	112.26
Häkchen, Nasenflügel-, LANGE	112.26
Häkchen, Ohr-, DAY	111.22
Häkchen, Ohr-, HARTMANN	111.21
Häkchen, Ohr-, LUCAE	111.22
Häkchen, Ohr-, WAGENER	111.22
Haken, Nasen-, AUFRICHT	112.29
Haken, Nasen-, AUFRICHT (WALTER).....	112.29
Haken, Nasen-, COTTLE.....	112.27, 112.28
Haken, Nasen-, COTTLE-NEIVERT	112.28
Haken, Ramus-, OBWEGESER.....	114.73, 114.74
Haken, Schleimhaut-, JOSEPH.....	112.25
Haken, spina nasalis-, OBWEGESER	114.73, 114.74
Haken, Weichteil-, OBWEGESER.....	114.72
Haken, Weisheitszahn-, OBWEGESER	114.74
HALLE, Rhinoplastik-Messer	112.11
HALLE, Septumelevator	112.13
Halter, Kinn-, OBWEGESER.....	114.73
Halter, Wangen- und Lippen-, BISHOP.....	114.59
Halter, Wangen- und Lippen-, MINNESOTA.....	114.59
Halter, Wangen- und Lippen-, SIMPLEX.....	114.59
Halter, Wangen- und Lippen-, STERNBERG.....	114.59
Hammerkopfzängchen, DIETER.....	111.16
HARTMANN / FRENCH, Stimmgabel.....	111.32
HARTMANN, Nasentamponzange	112.8
HARTMANN, Nasenzange.....	113.42
HARTMANN, Ohrhäkchen.....	111.21
HARTMANN, Ohrkatheter	111.29
HARTMANN, Ohrpolypenzange	111.5- 111.7
HARTMANN, Ohrspekula	111.2
HARTMANN, Stimmgabel	111.30, 111.34
HARTMANN, Zungendrucker	114.60
HARTMANN-HALLE, Nasenspekula	112.3
HARTMANN-HOFFMANN, Ohrpolypenzange.....	111.7
HARTMANN-WULLSTEIN, Ohrpolypenzange.....	111.6
Hautfasspinzette, COTTLE.....	112.39
Hebel, Fremdkörper-, BUCK	111.5
Hebel, Fremdkörper-, QUIRE	111.5
Hebel, Ohr-, ZAUFAL.....	111.21
HEISTER, Mundsperrerr	114.52
Hohlmeißel, BALLENGER.....	112.32
Hohlmeißel, FREER	112.32
Hohlmeißel, KILLIAN	112.32
Hohlmeißel, KILLIAN-CLAUS	112.32
HOUSE, Kürette	111.29

HOUSE, Mikro-Messsonde	111.28
HOWARTH, Septumelevator	112.16

J

JANSEN, Ohrkürette.....	111.20
JANSEN-MIDDLETON, Septumzange	113.44
JENNINGS, Mundsperrerr	114.54
Jochbeinahle, OBWEGESER.....	114.75
JOSEPH, Nasenraspel	112.21
JOSEPH, Nasensäge	112.17, 112.18
JOSEPH, Rhinoplastik-Messer.....	112.9, 112.10
JOSEPH, Schleimhauthaken.....	112.25
JOSEPH, Septumelevator	112.13
JOSEPH-MASING, Septumelevator.....	112.12

K

KABIERSKE, Ersatzflasche	111.36
KABIERSKE, Kanüle.....	111.36
KABIERSKE, Pulverbläser	111.36
KABIERSKE, Ventilball.....	111.36
Kanüle, KABIERSKE.....	111.36
Katheter, Ohr-, HARTMANN	111.29
KERRISON, Antrumstanze	112.2
KERRISON, Ohr-Knochenstanze	111.18
KILLIAN, Hohlmeißel	112.32
KILLIAN, Nasenspekula.....	112.4
KILLIAN, Septumelevator	112.16, 112.17
KILLIAN-CLAUS, Hohlmeißel	112.32
KILNER-DOUGHTY, Gaumenplatte.....	114.55
KILNER-DOUGHTY, Mundsperrerr	114.55
KILNER-DOUGHTY, Zungendrucker	114.55
Kinnhalter, OBWEGESER.....	114.73
Klemme, Mylohyoideus-, TERRY	114.65
Klemme, Ramus-, STEINHÄUSER.....	114.66
KNIGHT, Septumzange	113.46
Knochenhaltezange, STEINHÄUSER	114.64
Knochenstanze, Ohr-, BEYER.....	111.17
Knochenstanze, Ohr-, CITELLI.....	111.17
Knochenstanze, Ohr-, KERRISON	111.18
Knorpelquetsche, COTTLE	112.41
KRAUSE, Polypenschnürer	111.4, 112.7
KRAUSE-VOSS, Polypenschnürer	111.4, 112.7
KRESSNER, Septumrichtzange	112.40
Kürette, Antrum-, COAKLEY	112.30
Kürette, Antrum-, FAULKNER	112.30
Kürette, Antrum-, SEWALL.....	112.30
Kürette, HOUSE	111.29
Kürette, Ohr-, BARTH	111.20
Kürette, Ohr-, BUCK.....	111.19
Kürette, Ohr-, JANSEN.....	111.20
Kürette, Ohr-, LANGENBECK.....	111.20
Kürette, Ohr-, SHAPLEIGH.....	111.20

L

LANGE, Nasenflügelhäkchen	112.26
LANGENBECK, Fingerschutz.....	114.51



Alphabetisches Verzeichnis

LANGENBECK, Ohrkürette	111.20
Lappenmesser, PLESTER	111.26
LEWIS, Nasenraspel	112.19
Lippen- und Wangenhalter, BISHOP	114.59
Lippen- und Wangenhalter, MINNESOTA	114.59
Lippen- und Wangenhalter, SIMPLEX	114.59
Lippen- und Wangenhalter, STERNBERG	114.59
Löffel, Ohr-, GROSS	111.21
LUBET-BARBON, Nasentamponzange	112.8
LUC, Septumzange	113.46
LUCAE, Ohrhäkchen	111.22
LUCAE, Parazentesenadel	111.23
LUCAE, Stimmgabel	111.31, 111.34
Luftdusche, POLITZER	111.35

M

MALTZ, Nasenraspel	112.19, 112.24
MASING, Nasenraspel	112.22
MASING, Septumlevator	112.16
MAUNDER, Mundkeil	114.51
Maxilla-Mobilisator, OBWEGESER	114.71
MCKENTY, Septumlevator	112.12, 112.15
MCGEE, Drahtbiegezüngchen	111.14
MCGEE, Mikro-Ohrhäkchen	111.25
MCIVOR, Mundsperrerr	114.58
MCIVOR, Zungendrücker	114.58
Meißel, FOMON	112.35
Meißel, FREER	112.31
Meißel, Hohl-, BALLENGER	112.32
Meißel, Hohl-, FREER	112.32
Meißel, Hohl-, KILLIAN	112.32
Meißel, Hohl-, KILLIAN-CLAUS	112.32
Meißel, Nasen-, NEIVERT-ANDERSON	112.36
Meißel, Nasen-, PARKES	112.37
Meißel, Nasen-, SILVER	112.36
Meißel, WALTER	112.34
Meißel, WEST	112.31
Messer, Lappen-, PLESTER	111.26
Messer, Mukosa-, FREER	112.10
Messer, Rhinoplastik-, CONVERSE	112.10
Messer, Rhinoplastik-, COTTLE	112.10
Messer, Rhinoplastik-, FOMON	112.9
Messer, Rhinoplastik-, HALLE	112.11
Messer, Rhinoplastik-, JOSEPH	112.9, 112.10
Messer, Rhinoplastik-, ULRICH	112.11
Messer, Ring-, BECKMANN	112.37, 112.38
Messer, Schleimhaut-, TABB	111.26
Messer, Schwing-, BALLENGER	112.11
Messer, Sichel-, SCHUKNECHT	111.27
Messer, Sichel-, WULLSTEIN	111.27
Messsonde, Mikro-, HOUSE	111.28
Metallolive	111.38
Metallständer	111.3
Mikro-Dissektor, FISCH	111.28
Mikro-Messsonde, HOUSE	111.28
Mikro-Ohrhäkchen, BARBARA	111.24

Mikro-Ohrhäkchen, MCGEE	111.25
Mikro-Ohrmesser, ROSEN	111.26
Mikro-Ohrnadel	111.25
Mikro-Ohrnadel, BARBARA	111.24, 111.25
Mikro-Ohrnadel, ROSEN	111.24
Mikro-Ohrschere, BELLUCCI	111.15
Mikro-Ohrzüngchen	111.9- 111.12
Mikro-Ohrzüngchen, MINI-MCGEE	111.8,3 111.13
MILLER, Nasenraspel	112.23
MINI-MCGEE, Mikro-Ohrzüngchen	111.8, 111.13
MINNESOTA, Lippen- und Wangenhalter	114.59
Mobilisator, Maxilla-, OBWEGESER	114.71
MOLT, Mundsperrerr	114.52
Mukosamesser, FREER	112.10
Mundkeil, MAUNDER	114.51
Mundkeil, PITHA	114.51
Mundsperrerr, DAVIS-BOYLE	114.57
Mundsperrerr, DENHART	114.53
Mundsperrerr, DINGMANN	114.56
Mundsperrerr, HEISTER	114.52
Mundsperrerr, JENNINGS	114.54
Mundsperrerr, KILNER-DOUGHTY	114.55
Mundsperrerr, MCIVOR	114.58
Mundsperrerr, MOLT	114.52
Mundsperrerr, ORINGER	114.54
Mundsperrerr, ROSER-KÖNIG	114.53
Mylohyoideusklemme, TERRY	114.65

N

Nadel, Parazentesen-, LUCAE	111.23
Nadel, Parazentesen-, POLITZER	111.23
Nasenflügelhäkchen, COTTLE	112.26
Nasenflügelhäkchen, FOMON	112.26
Nasenflügelhäkchen, LANGE	112.26
Nasenhaken, AUFRICHT	112.29
Nasenhaken, AUFRICHT (WALTER)	112.29
Nasenhaken, COTTLE	112.27, 112.28
Nasenhaken, COTTLE-NEIVERT	112.28
Nasenmeißel, NEIVERT-ANDERSON	112.36
Nasenmeißel, PARKES	112.37
Nasenmeißel, SILVER	112.36
Nasenolive, POLITZER	111.35
Nasenraspel, AUFRICHT	112.20
Nasenraspel, COTTLE	112.20
Nasenraspel, FOMON	112.22, 112.24
Nasenraspel, GALLAHER	112.21
Nasenraspel, JOSEPH	112.21
Nasenraspel, LEWIS	112.19
Nasenraspel, MALTZ	112.19, 112.24
Nasenraspel, MASING	112.22
Nasenraspel, MILLER	112.23
Nasenraspel, WIENER	112.22
Nasensäge, JOSEPH	112.17, 112.18
Nasenspekula, BECKMANN	112.3
Nasenspekula, COTTLE	112.5
Nasenspekula, HARTMANN-HALLE	112.3

Alphabetisches Verzeichnis

Nasenspekula, KILLIAN.....	112.4
Nasenspekula, THUDICHUM.....	112.6
Nasenspekula, TIECK-HALLE.....	112.3
Nasenspekula, VIENNA (WIEN).....	112.5
Nasentamponzange, HARTMANN.....	112.8
Nasentamponzange, LUBET-BARBON.....	112.8
Nasentamponzange, WESTMACOTT.....	112.8
Nasenzange, HAJEK-KOFLER.....	113.47
Nasenzange, HARTMANN.....	113.42
Nasenzange, SCHMIEDEN.....	113.43
Nasenzange, STRUYCKEN.....	113.43
Nasenzange, TAKAHASHI.....	113.43
Nasenzange, WATSON-WILLIAMS.....	113.42
Nasenzange, WEIL-BLAKESLEY.....	113.48, 113.49
NEIVERT-ANDERSON, Nasenmeißel.....	112.36

O

OBWEGESER, Jochbogenahle.....	114.75
OBWEGESER, Kinnhalter.....	114.73
OBWEGESER, Maxilla-Mobilisator.....	114.71
OBWEGESER, Osteotom.....	114.70, 114.71
OBWEGESER, Progeniereinne.....	114.73
OBWEGESER, Ramushaken.....	114.73
OBWEGESER, Raspatorium.....	114.68, 114.69
OBWEGESER, spina nasalis-Haken.....	114.73, 114.74
OBWEGESER, Unterkieferahle.....	114.75
OBWEGESER, Weichteilhaken.....	114.72
OBWEGESER, Weisheitszahn-Haken.....	114.74
Ohrhäkchen, DAY.....	111.22
Ohrhäkchen, HARTMANN.....	111.21
Ohrhäkchen, LUCAE.....	111.22
Ohrhäkchen, Mikro-, BARBARA.....	111.24
Ohrhäkchen, Mikro-, MCGEE.....	111.25
Ohrhäkchen, WAGENER.....	111.22
Ohrhebel, ZAUFAL.....	111.21
Ohrkatheter, HARTMANN.....	111.29
Ohr-Knochenstanze, BEYER.....	111.17
Ohr-Knochenstanze, CITELLI.....	111.17
Ohr-Knochenstanze, KERRISON.....	111.18
Ohrkürette, BARTH.....	111.20
Ohrkürette, BUCK.....	111.19
Ohrkürette, JANSEN.....	111.20
Ohrkürette, LANGENBECK.....	111.20
Ohrkürette, SHAPLEIGH.....	111.20
Ohrlöffel, GROSS.....	111.21
Ohrmesser, Mikro-, ROSEN.....	111.26
Ohrnadel, Mikro-.....	111.25
Ohrnadel, Mikro-, BARBARA.....	111.24,3 111.25
Ohrnadel, Mikro-, ROSEN.....	111.24
Ohrolive, POLITZER.....	111.35
Ohrpolypenzange, HARTMANN.....	111.5- 111.7
Ohrpolypenzange, HARTMANN-HOFFMANN.....	111.7
Ohrpolypenzange, HARTMANN-WULLSTEIN.....	111.6
Ohrpolypenzange, STRUEMPEL.....	111.7
Ohrscheren, Mikro-, BELLUCCI.....	111.15
Ohrspekula, HARTMANN.....	111.2

Ohrspekula, TOYNBEE.....	111.2
Ohrspekula, ZÖLLNER.....	111.3
Ohrspritze.....	111.37, 111.38
Ohrzängchen, Mikro-.....	111.9- 111.12
Ohrzängchen, Mikro-, MINI MCGEE.....	111.8, 111.13
ORINGER, Mundsperrer.....	114.54
Osteotom, BAUER.....	114.67
Osteotom, CINELLI.....	112.35
Osteotom, COTTLE.....	112.33, 112.34
Osteotom, EPKER.....	114.68
Osteotom, EPKER-BAUER.....	114.67
Osteotom, OBWEGESER.....	114.70, 114.71
Osteotom, RUBIN.....	112.35
Osteotom, TESSIER.....	114.75, 114.76
Osteotom, WALTER.....	112.34
Osteotom, WEST.....	112.31

P

Palatumspreizer, TURVEY.....	114.66
Parazentesenadel, LUCAE.....	111.23
Parazentesenadel, POLITZER.....	111.23
PARKES, Nasenmeißel.....	112.37
PENNINGTON, Septumelevators.....	112.17
Pinzette, Columella-, COTTLE.....	112.39
Pinzette, Hautfass-, COTTLE.....	112.39
PITHA, Mundkeil.....	114.51
Platte, Gaumen-, KILNER DOUGHTY.....	114.55
PLESER, Lappenmesser.....	111.26
POLITZER, Einsteckkonus.....	111.35
POLITZER, Gummibirne.....	111.35
POLITZER, Luftdusche.....	111.35
POLITZER, Nasenolive.....	111.35
POLITZER, Ohrolive.....	111.35
POLITZER, Parazentesenadel.....	111.23
Polypenschnürer, KRAUSE.....	111.4, 112.7
Polypenschnürer, KRAUSE-VOSS.....	111.4, 112.7
Progenierinne, OBWEGESER.....	114.73
Pulverbläser, KABIERSKE.....	111.36

Q

Quetsche, Knorpel-, COTTLE.....	112.41
QUIRE, Fremdkörperhebel.....	111.5

R

Ramushaken, OBWEGESER.....	114.73, 114.74
Ramusklemme, STEINHÄUSER.....	114.66
Raspatorium, OBWEGESER.....	114.68, 114.69
Raspel, Nasen-, AUFRICHT.....	112.20
Raspel, Nasen-, COTTLE.....	112.20
Raspel, Nasen-, FOMON.....	112.22, 112.24
Raspel, Nasen-, GALLAHER.....	112.21
Raspel, Nasen-, JOSEPH.....	112.21
Raspel, Nasen-, LEWIS.....	112.19
Raspel, Nasen-, MALTZ.....	112.19, 112.24
Raspel, Nasen-, MASING.....	112.22
Raspel, Nasen-, MILLER.....	112.23



Alphabetisches Verzeichnis

Raspel, Nasen-, WIENER.....	112.22
Repositionszange, ROWE.....	114.63
Rhinoplastik-Messer, CONVERSE.....	112.10
Rhinoplastik-Messer, COTTLE.....	112.10
Rhinoplastik-Messer, FOMON.....	112.9
Rhinoplastik-Messer, HALLE.....	112.11
Rhinoplastik-Messer, JOSEPH.....	112.9, 112.10
Rhinoplastik-Messer, ULRICH.....	112.11
Ringmesser, BECKMANN.....	112.37, 112.38
ROSEN, Mikro-Ohrmesser.....	111.26
ROSEN, Mikro-Ohrnadel.....	111.24
ROSER-KÖNIG, Mundsperrer.....	114.53
ROWE, Repositionszange.....	114.63
RUBIN, Osteotom.....	112.35
RUBIN, Septumquetschzange.....	112.41
RYDEL-SEIFFER, Stimmgabel.....	111.34

S

Säge, Nasen-, JOSEPH.....	112.17, 112.18
Saugansatz.....	111.38
Schleimhauthaken, JOSEPH.....	112.25
Schleimhautmesser, TABB.....	111.26
SCHMIEDEN, Nasenzange.....	113.43
Schnürdraht.....	111.4, 112.7
Schnürer, Polypen-, KRAUSE.....	111.4, 112.7
Schnürer, Polypen-, KRAUSE-VOSS.....	111.4, 112.7
SCHUKNECHT, Sichelmesser.....	111.27
Schutzteller.....	111.37
Schwingmesser, BALLENGER.....	112.11, 112.12
Septumelevator, COTTLE.....	112.15
Septumelevator, FREER.....	112.13, 112.14
Septumelevator, HALLE.....	112.13
Septumelevator, HOWARTH.....	112.16
Septumelevator, JOSEPH.....	112.13
Septumelevator, JOSEPH-MASING.....	112.12
Septumelevator, KILLIAN.....	112.16, 112.17
Septumelevator, MASING.....	112.16
Septumelevator, MCKENTY.....	112.12, 112.15
Septumelevator, PENNINGTON.....	112.17
Septumquetschzange, RUBIN.....	112.41
Septumrichtzange, ASCH.....	112.39
Septumrichtzange, KRESSNER.....	112.40
Septumrichtzange, WALSHAM.....	112.40
Septumzange, BRÜNINGS.....	113.45
Septumzange, GRAIG.....	113.44
Septumzange, GRAIG-DOMNICK.....	113.45
Septumzange, JANSEN-MIDDELTON.....	113.44
Septumzange, KNIGHT.....	113.46
Septumzange, LUC.....	113.46
SEWALL, Antrumkürette.....	112.30
SHAPLEIGH, Ohrkürette.....	111.20
Sichelmesser, SCHUKNECHT.....	111.27
Sichelmesser, WULLSTEIN.....	111.27
SILVER, Nasenmeißel.....	112.36
SIMPLEX, Lippen- und Wangenhalter.....	114.59
SMITH, Spreizzange.....	114.64

Spatel, Zungen-, BRÜNINGS.....	114.61
Spatel, Zungen-, DOYEN.....	114.61
Spekula, Nasen-, BECKMANN.....	112.3
Spekula, Nasen-, COTTLE.....	112.5
Spekula, Nasen-, HARTMANN-HALLE.....	112.3
Spekula, Nasen-, KILLIAN.....	112.4
Spekula, Nasen-, THUDICHUM.....	112.6
Spekula, Nasen-, TIECK-HALLE.....	112.3
Spekula, Nasen-, VIENNA (WIEN).....	112.5
Spekula, Ohr-, HARTMANN.....	111.2
Spekula, Ohr-, TOYNBEE.....	111.2
Spekula, Ohr-, ZÖLLNER.....	111.3
Sperrer, Mund-, DAVIS-BOYLE.....	114.57
Sperrer, Mund-, DENHART.....	114.53
Sperrer, Mund-, DINGMANN.....	114.56
Sperrer, Mund-, HEISTER.....	114.52
Sperrer, Mund-, JENNINGS.....	114.54
Sperrer, Mund-, KILNER-DOUGHTY.....	114.55
Sperrer, Mund-, MCIVOR.....	114.58
Sperrer, Mund-, MOLT.....	114.52
Sperrer, Mund-, ORINGER.....	114.54
Sperrer, Mund-, ROSER-KÖNIG.....	114.53
spina nasalis-Haken, OBWEGESER.....	114.73, 114.74
Spreizer, Palatum-, TURVEY.....	114.66
Spreizzange, SMITH.....	114.64
Spülansatz.....	111.37
Stanze, Antrum-.....	113.50
Stanze, Antrum-, KERRISON.....	112.2
STEINHÄUSER, Knochenhalte-zange.....	114.64
STEINHÄUSER, Ramusklemme.....	114.66
STERNBERG, Lippen- und Wangenhalter.....	114.59
Stimmgabel.....	111.34
Stimmgabel, aluminium.....	111.33
Stimmgabel, HARTMANN.....	111.30, 111.34
Stimmgabel, HARTMANN / FRENCH.....	111.32
Stimmgabel, LUCAE.....	111.31, 111.34
Stimmgabel, RYDEL-SEIFFER.....	111.34
STRUEMPEL, Ohrpolypenzange.....	111.7
STRUYCKEN, Nasenzange.....	113.43

T

TABB, Schleimhautmesser.....	111.26
TAKAHASHI, Nasenzange.....	113.43
TERRY, Mylohyoideusklemme.....	114.65
TESSIER, Osteotom.....	114.76
THUDICHUM, Nasenspekula.....	112.6
TIECK-HALLE, Nasenspekula.....	112.3
TOBOLD, Zungendrücker.....	114.60
TOYNBEE, Ohrspekula.....	111.2
TURVEY, Palatumspreizer.....	114.66

U

ULRICH, Rhinoplastik-Messer.....	112.11
Unterkieferahle, OBWEGESER.....	114.75

Alphabetisches Verzeichnis

V

Ventilaufsatz	111.38
Ventilball, KABIERSKE	111.36
Verbindungsschlauch	111.38
VIENNA (WIEN), Nasenspekula	112.5

W

WAGENER, Ohrhäkchen	111.22
WALSHAM, Septumrichtzange	112.40
WALTER, Meißel	112.34
WALTER, Osteotom	112.34
WATSON-WILLIAMS, Nasenzange	113.42
Weichteilhaken, OBWEGESER	114.72
WEIL-BLAKESLEY, Nasenzange	113.48, 113.49
Weisheitszahn-Haken, OBWEGESER	114.74
WEST, Meißel	112.31
WEST, Osteotom	112.31
WESTMACOTT, Nasentamponzange	112.8
WIEDER, Zungendrucker	114.60
WIENER, Nasenraspel	112.22
WULLSTEIN, Sichelmesser	111.27

Y

YOUNG, Gummipolster	114.62
YOUNG, Zungenzange	114.62

Z

Zängchen, Drahtbiege-, MCGEE	111.14
Zängchen, Hammerkopf-, DIETER	111.16
Zange, Knochenhalte-, STEINHÄUSER	114.64
Zange, Nasen-, HAJEK-KOFLER	113.47
Zange, Nasen-, HARTMANN	113.42
Zange, Nasen-, SCHMIEDEN	113.43
Zange, Nasen-, STRUYCKEN	113.43
Zange, Nasen-, TAKAHASHI	113.43
Zange, Nasen-, WATSON-WILLIAMS	112.41
Zange, Nasen-, WEIL-BLAKESLEY	113.48, 113.49
Zange, Nasentampon-, HARTMANN	112.8
Zange, Nasentampon-, LUBET-BARBON	112.8
Zange, Nasentampon-, WESTMACOTT	112.8
Zange, Ohrpolypen-, HARTMANN	111.5- 111.7
Zange, Ohrpolypen-, HARTMANN-HOFFMANN	111.7
Zange, Ohrpolypen-, HARTMANN-WULLSTEIN	111.6
Zange, Ohrpolypen-, STRUEMPEL	111.7
Zange, Repositions-, ROWE	114.63
Zange, Septum-, BRÜNINGSS	113.45
Zange, Septum-, GRAIG	113.44
Zange, Septum-, GRAIG-DOMNICK	113.45
Zange, Septum-, JANSEN-MIDDLETON	113.44
Zange, Septum-, KNIGHT	113.46
Zange, Septum-, LUC	113.46
Zange, Septumquetsch-, RUBIN	112.41
Zange, Septumricht-, ASCH	112.39
Zange, Septumricht-, KRESSNER	112.40
Zange, Septumricht-, WALSHAM	112.40
Zange, Spreiz-, SMITH	114.64

Zange, Zungen-, COLLIN	114.62
Zange, Zungen-, YOUNG	114.62
ZAUFAL, Ohrhebel	111.21
ZÖLLNER, Ohrspekula	111.3
Zungendrucker, MCIVOR	114.58
Zungendrucker, DAVIS-BOYLE	114.57
Zungendrucker, DINGMANN	114.56
Zungendrucker, HARTMANN	114.60
Zungendrucker, KILNER-DOUGHTY	114.55
Zungendrucker, TOBOLD	114.60
Zungendrucker, WIEDER	114.60
Zungenspatel, BRÜNINGSS	114.61
Zungenspatel, DOYEN	114.61
Zungenzange, COLLIN	114.62
Zungenzange, YOUNG	114.62
Zygoma-Elevatorium, GILLIES	114.63



Index, alphabetical

A	
adenoid curette, BECKMANN	112.37, 112.38
air bag, POLITZER	111.35
alar hook, COTTLE	112.26
alar hook, FOMON	112.26
alar hook, LANGE	112.26
aluminium, tuning fork	111.33
antrum curette, COAKLEY	112.30
antrum curette, FAULKNER	112.30
antrum curette, SEWALL	112.30
antrum punch	113.50
antrum punch, KERRISON	112.2
ASCH, septum straightening forceps	112.39
atomizer, KABIERSKE	111.36
AUFRICHT (WALTER), nasal retractor	112.29
AUFRICHT, nasal rasp	112.20
AUFRICHT, nasal retractor	112.29
awl, maxillary, OBWEGESER	114.75
awl, zygomatic arch, OBWEGESER	114.75
B	
BALLENGER, gouge	112.32
BALLENGER, septum elevator	112.12
BALLENGER, swivel knife	112.11
BARBARA, micro ear hook	111.24
BARBARA, micro ear needle	111.24, 111.25
BARTH, ear curette	111.20
BAUER, osteotom	114.67
BECKMANN, adenoid curette	112.37, 112.38
BECKMANN, nasal specula	112.3
BELLUCCI, micro ear scissors	111.15
BEYER, mastoid rongeur	111.17
BILLEAU, foreign body instrument	111.21
BISHOP, lip and cheek retractor	114.59
bone holding forceps, STEINHÄUSER	114.64
BRUENINGS, septum forceps	113.45
BRÜNINGS, tongue spatula	114.61
BUCK, ear curette	111.19
BUCK, foreign body lever	111.5
C	
cannula, KABIERSKE	111.36
cartilage crusher, COTTLE	112.41
catheter, ear, HARTMANN	111.29
channel retractor, OBWEGESER	114.73
chin retractor, OBWEGESER	114.73
chisel, FOMON	112.35
chisel, FREER	112.31
chisel, rhinoplastic, NEIVERT-ANDERSON	112.36
chisel, rhinoplastic, PARKES	112.37
chisel, rhinoplastic, SILVER	112.36
chisel, WALTER	112.34
chisel, WEST	112.31
CINELLI, osteotom	112.35
CITELLI, mastoid rongeur	111.17
clamp, mylohyoid muscle, TERRY	114.65
clamp, ramus, STEINHÄUSER	114.66
COAKLEY, antrum curette	112.30
COLLIN, tongue holding forceps	114.62
columella forceps, COTTLE	112.39
connecting nozzle, POLITZER	111.35
CONVERSE, rhinoplastic knife	112.10
COTTLE, alar hook	112.26
COTTLE, cartilage crusher	112.41
COTTLE, columella forceps	112.39
COTTLE, guide support	112.41
COTTLE, handle	112.41
COTTLE, nasal rasp	112.20
COTTLE, nasal retractor	112.27, 112.28
COTTLE, nasal specula	112.5
COTTLE, osteotom	112.33, 112.34
COTTLE, rhinoplastic knife	112.10
COTTLE, septum elevator	112.15
COTTLE, skin grasping forceps	112.39
COTTLE-NEIVERT, nasal retractor	112.28
crusher, cartilage, COTTLE	112.41
curette, adenoid, BECKMANN	112.37, 112.38
curette, antrum, COAKLEY	112.30
curette, antrum, FAULKNER	112.30
curette, antrum, SEWALL	112.30
curette, ear, BARTH	111.20
curette, ear, BUCK	111.19
curette, ear, JANSEN	111.20
curette, ear, LANGENBECK	111.20
curette, ear, SHAPLEIGH	111.20
curette, HOUSE	111.29
D	
DAVIS-BOYLE, mouth gag	114.57
DAVIS-BOYLE, tongue depressor	114.57
DAY, ear hook	111.22
DENHART, mouth gag	114.53
depressor, tongue, DAVIS-BOYLE	114.57
depressor, tongue, DINGMANN	114.56
depressor, tongue, HARTMANN	114.60
depressor, tongue, KILNER-DOUGHTY	114.55
depressor, tongue, MCIVOR	114.58
depressor, tongue, TOBOLD	114.60
depressor, tongue, WIEDER	114.60
DIETER, malleus nipper	111.16
DINGMANN, mouth gag	114.56
DINGMANN, tongue depressor	114.56
disimpaction forceps, ROWE	114.63
dissector, micro, FISCH	111.28
DOYEN, tongue spatula	114.61
E	
ear catheter, HARTMANN	111.29
ear curette, BARTH	111.20
ear curette, BUCK	111.19
ear curette, JANSEN	111.20
ear curette, LANGENBECK	111.20

Index, alphabetical

ear curette, SHAPLEIGH	111.20
ear forceps, HARTMANN	111.5- 111.7
ear forceps, HARTMANN-HOFFMANN	111.7
ear forceps, HARTMANN-WULLSTEIN	111.6
ear forceps, STRUEMPEL	111.7
ear hook, DAY	111.22
ear hook, LUCAE	111.22
ear hook, WAGENER	111.22
ear hooklet, HARTMANN	111.21
ear olive, POLITZER	111.35
ear scoop, GROSS	111.21
ear specula, HARTMANN	111.2
ear specula, TOYNBEE	111.2
ear specula, ZÖLLNER	111.3
ear syringe	111.37, 111.38
elevator, periosteal, OBWEGESER	114.68, 114.69
elevator, septum, BALLENGER	112.12
elevator, septum, COTTLE	112.15
elevator, septum, FREER	112.13, 112.14
elevator, septum, HALLE	112.13
elevator, septum, HOWARTH	112.16
elevator, septum, JOSEPH	112.13
elevator, septum, KILLIAN	112.16, 112.17
elevator, septum, MASING	112.16
elevator, septum, MCKENTY	112.12, 112.15
elevator, septum, PENNINGTON	112.17
elevator, zygoma, GILLIES	114.63
elevator,septum, JOSEPH-MASING	112.12
EPKER, osteotom	114.68
EPKER-BAUER, osteotom	114.67
expander palatal, TURVEY	114.66

F

FAULKNER, antrum curette	112.30
finger protector, LANGENBECK	114.51
FISCH, micro dissector	111.28
flap knife, PLESTER	111.26
flexible tube	111.38
FOMON, alar hook	112.26
FOMON, chisel	112.35
FOMON, nasal rasp	112.22, 112.24
FOMON, rhinoplastic knife	112.9
forceps, bone holding, STEINHÄUSER	114.64
forceps, columella, COTTLE	112.39
forceps, disimpaction, ROWE	114.63
forceps, ear, HARTMANN	111.5- 111.7
forceps, ear, HARTMANN-HOFFMANN	111.7
forceps, ear, HARTMANN-WULLSTEIN	111.6
forceps, ear, STRUEMPEL	111.7
forceps, micro ear	111.9- 111.12
forceps, micro ear, MINI MCGEE	111.8, 111.13
forceps, nasal tampon, HARTMANN	112.8
forceps, nasal tampon, LUBET-BARON	112.8
forceps, nasal tampon, WESTMACOTT	112.8
forceps, nasal, HAJEK-KOFLER	113.47
forceps, nasal, HARTMANN	113.42

forceps, nasal, SCHMIEDEN	113.43
forceps, nasal, STRUYCKEN	113.43
forceps, nasal, TAKAHASHI	113.43
forceps, nasal, WATSON-WILLIAMS	113.42
forceps, nasal, WEIL-BLAKESLEY	113.48, 113.49
forceps, septum, BRUENINGS	113.45
forceps, septum, GRAIG	113.44
forceps, septum, GRAIG-DOMNICK	113.45
forceps, septum, JANSEN-MIDDLETON	113.44
forceps, septum, KNIGHT	113.46
forceps, septum, LUC	113.46
forceps, skin grasping, COTTLE	112.39
forceps, straightening, ASCH	112.39
forceps, straightening, KRESSNER	112.40
forceps, straightening, WALSHAM	112.40
forceps, tongue holding, COLLIN	114.62
forceps, tongue holding, YOUNG	114.62
forceps, wire bending, MCGEE	111.14
foreign body instrument, BILLEAU	111.21
foreign body lever, BUCK	111.5
foreign body lever, QUIRE	111.5
foreign body lever, ZAUFAL	111.21
fork, tuning	111.34
fork, tuning, aluminium	111.33
fork, tuning, HARTMANN	111.30, 111.34
fork, tuning, HARTMANN / FRENCH	111.32
fork, tuning, LUCAE	111.31, 111.34
fork, tuning, RYDEL-SEIFFER	111.34
FREER, chisel	112.31
FREER, gouge	112.32
FREER, mucosa knife	112.10
FREER, septum elevator	112.13, 112.14

G

GALLAHER, nasal rasp	112.21
GILLIES, zygoma elevator	114.63
gouge, BALLENGER	112.32
gouge, FREER	112.32
gouge, KILLIAN	112.32
gouge, KILLIAN-CLAUS	112.32
GRAIG, septum forceps	113.44
GRAIG-DOMNICK, septum forceps	113.45
GROSS, ear scoop	111.21
guide support, COTTLE	112.41

H

HAJEK-KOFLER, nasal forceps	113.47
HALLE, rhinoplastic knife	112.11
HALLE, septum elevator	112.13
handle, COTTLE	112.41
HARTMANN / FRENCH, tuning fork	111.32
HARTMANN, ear catheter	111.29
HARTMANN, ear forceps	111.5- 111.7
HARTMANN, ear hooklet	111.21
HARTMANN, ear specula	111.2
HARTMANN, nasal forceps	113.42



Index, alphabetical

HARTMANN, nasal tampon forceps.....	112.8
HARTMANN, tongue depressor	114.60
HARTMANN, tuning fork	111.30, 111.34
HARTMANN-HALLE, nasal specula.....	112.3
HARTMANN-HOFFMANN, ear forceps.....	111.7
HARTMANN-WULLSTEIN, ear forceps.....	111.6
HEISTER, mouth gag	114.52
hook, alar, COTTLE	112.26
hook, alar, FOMON.....	112.26
hook, alar, LANGE	112.26
hook, ear, DAY	111.22
hook, ear, LUCAE	111.22
hook, ear, WAGENER.....	111.22
hook, micro ear, BARBARA.....	111.24
hook, micro ear, MCGEE.....	111.25
hooklet, ear, HARTMANN.....	111.21
hooklet, mucosa, JOSEPH.....	112.25
HOUSE, curette.....	111.29
HOUSE, micro measuring rod.....	111.28
HOWARTH, septum elevator.....	112.16

I	
irrigation adapter	111.37

J	
JANSEN, ear curette	111.20
JANSEN-MIDDLETON, septum forceps	113.44
JENNINGS, mouth gag	114.54
JOSEPH, mucosa hooklet.....	112.25
JOSEPH, nasal rasp	112.21
JOSEPH, nasal saw.....	112.17, 112.18
JOSEPH, rhinoplastic knife	112.9, 112.10
JOSEPH, septum elevator.....	112.13
JOSEPH-MASING, septum elevator.....	112.12

K	
KABIERSKE, atomizer	111.36
KABIERSKE, cannula	111.36
KABIERSKE, spare bottle.....	111.36
KABIERSKE, valve rubber bulb.....	111.36
KERRISON, antrum punch.....	112.2
KERRISON, mastoid rongeur	111.18
KILLIAN, gouge	112.32
KILLIAN, nasal specula	112.4
KILLIAN, septum elevator	112.16, 112.17
KILLIAN-CLAUS, gouge.....	112.32
KILNER-DOUGHTY, mouth gag.....	114.55
KILNER-DOUGHTY, palate plate.....	114.55
KILNER-DOUGHTY, tongue depressor	114.55
knife, flap, PLESTER	111.26
knife, micro ear, ROSEN.....	111.26
knife, mucosa, FREER.....	112.10
knife, mucosa, TABB	111.26
knife, rhinoplastic, CONVERSE.....	112.10
knife, rhinoplastic, COTTLE.....	112.10
knife, rhinoplastic, FOMON.....	112.9

knife, rhinoplastic, HALLE	112.11
knife, rhinoplastic, JOSEPH	112.9, 112.10
knife, rhinoplastic, ULRICH.....	112.11
knife, sickle, SCHUKNECHT.....	111.27
knife, sickle, WULLSTEIN.....	111.27
knife, swivel, BALLENGER.....	112.11
KNIGHT, septum forceps	113.46
KRAUSE, polypus snares.....	111.4, 112.7
KRAUSE-VOSS, polypus snares.....	111.4, 112.7
KRESSNER, septum straghtening forceps	112.40

L	
LANGE, alar hook.....	112.26
LANGENBECK, ear curette	111.20
LANGENBECK, finger protector.....	114.51
lever, foreign body, BUCK	111.5
lever, foreign body, QUIRE	111.5
lever, foreign body, ZAUFAL.....	111.21
LEWIS, nasal rasp	112.19
lip and cheek retractor, BISHOP	114.59
lip and cheek retractor, MINNESOTA	114.59
lip and cheek retractor, SIMPLEX.....	114.59
lip and cheek retractor, STERNBERG	114.59
LUBET-BARBON, nasal tampon forceps	112.8
LUC, septum forceps	113.46
LUCAE, ear hook.....	111.22
LUCAE, tuning fork.....	111.31, 111.34
LUCAE, tympanum needle.....	111.23

M	
malleus nipper, DIETER.....	111.16
MALTZ, nasal rasp.....	112.19, 112.24
MASING, nasal rasp	112.22
MASING, septum elevator.....	112.16
mastoid rongeur, BEYER.....	111.17
mastoid rongeur, CITELLI.....	111.17
mastoid rongeur, KERRISON	111.18
MAUNDER, mouth gag	114.51
maxillary awl, OBWEGESER.....	114.75
maxillary mobilizer, OBWEGESER.....	114.71
MCKENTY, septum elevator.....	112.12, 112.15
MCGEE wire bending forceps	111.14
MCGEE, micro ear hook.....	111.25
MCIVOR, mouth gag	114.58
MCIVOR, tongue depressor	114.58
measuring rod, micro, HOUSE.....	111.28
metal olive	111.38
micro dissector, FISCH.....	111.28
micro ear forceps	111.9- 111.12
micro ear forceps, MINI MCGEE.....	111.8, 111.13
micro ear hook, MCGEE.....	111.25
micro ear knife, ROSEN	111.26
micro ear needle.....	111.25
micro ear needle, BARBARA.....	111.24, 111.25
micro ear needle, ROSEN	111.24
micro ear scissors, BELLUCCI.....	111.15

Index, alphabetical

micro hear hook, BARBARA.....	111.24
micro measuring rod, HOUSE.....	111.28
MILLER, nasal rasp.....	112.23
MINI MCGEE, micro ear forceps.....	111.8, 111.13
MINNESOTA, lip and cheek retractor.....	114.59
mobilizer, maxillary, OBWEGESER.....	114.71
MOLT, mouth gag.....	114.52
morselizer, septum, RUBIN.....	112.41
mouth gag, DAVIS-BOYLE.....	114.57
mouth gag, DENHART.....	114.53
mouth gag, DINGMANN.....	114.56
mouth gag, HEISTER.....	114.52
mouth gag, JENNINGS.....	114.54
mouth gag, KILNER-DOUGHTY.....	114.55
mouth gag, MAUNDER.....	114.51
mouth gag, MCIVOR.....	114.58
mouth gag, MOLT.....	114.52
mouth gag, ORINGER.....	114.54
mouth gag, PITHA.....	114.51
mouth gag, ROSER-KÖNIG.....	114.53
mucosa hooklet, JOSEPH.....	112.25
mucosa knife, FREER.....	112.10
mucosa knife, TABB.....	111.26
mylohyoid muscle clamp, TERRY.....	114.65

N

nasal forceps, HAJEK-KOFLER.....	113.47
nasal forceps, HARTMANN.....	113.42
nasal forceps, SCHMIEDEN.....	113.43
nasal forceps, STRUYCKEN.....	113.43
nasal forceps, TAKAHASHI.....	113.43
nasal forceps, WATSON-WILLIAMS.....	113.42
nasal forceps, WEIL-BLAKESLEY.....	113.48, 113.49
nasal rasp, AUFRICHT.....	112.20
nasal rasp, COTTLE.....	112.20
nasal rasp, FOMON.....	112.22, 112.24
nasal rasp, GALLAHER.....	112.21
nasal rasp, JOSEPH.....	112.21
nasal rasp, LEWIS.....	112.19
nasal rasp, MALTZ.....	112.19, 112.24
nasal rasp, MASING.....	112.22
nasal rasp, MILLER.....	112.23
nasal rasp, WIENER.....	112.22
nasal retractor, AUFRICHT.....	112.29
nasal retractor, AUFRICHT (WALTER).....	112.29
nasal retractor, COTTLE.....	112.27, 112.28
nasal retractor, COTTLE-NEIVERT.....	112.28
nasal saw, JOSEPH.....	112.17, 112.18
nasal specula, BECKMANN.....	112.3
nasal specula, COTTLE.....	112.5
nasal specula, HARTMANN-HALLE.....	112.3
nasal specula, KILLIAN.....	112.4
nasal specula, THUDICHUM.....	112.6
nasal specula, TIECK-HALLE.....	112.3
nasal specula, VIENNA (WIEN).....	112.5
nasal spine retractor, OBWEGESER.....	114.73, 114.74

nasal tampon forceps, HARTMANN.....	112.8
nasal tampon forceps, LUBET-BARBON.....	112.8
nasal tampon forceps, WESTMACOTT.....	112.8
needle, micro ear.....	111.25
needle, micro ear, BARBARA.....	111.24, 111.25
needle, micro ear, ROSEN.....	111.24
needle, tympanum, LUCAE.....	111.23
needle, tympanum, POLITZER.....	111.23
NEIVERT-ANDERSON, rhinoplastic chisel.....	112.36
nipper, malleus, DIETER.....	111.16
nose olive, POLITZER.....	111.35

O

OBWEGESER, channel retractor.....	114.73
OBWEGESER, chin retractor.....	114.73
OBWEGESER, maxillary awl.....	114.75
OBWEGESER, nasal spine retractor.....	114.73, 114.74
OBWEGESER, osteotom.....	114.70, 114.71
OBWEGESER, periosteal elevator.....	114.68, 114.69
OBWEGESER, ramus retractor.....	114.73, 114.74
OBWEGESER, soft tissue retractor.....	114.72
OBWEGESER, third molar retractor.....	114.74
OBWEGESER, zygomatic arch awl.....	114.75
OGWEGESER, maxillary mobilizer.....	114.71
ORINGER, mouth gag.....	114.54
osteotom, BAUER.....	114.67
osteotom, CINELLI.....	112.35
osteotom, COTTLE.....	112.33, 112.34
osteotom, EPKER.....	114.68
osteotom, EPKER-BAUER.....	114.67
osteotom, OBWEGESER.....	114.70, 114.71
osteotom, RUBIN.....	112.35
osteotom, TESSIER.....	114.76
osteotom, WALTER.....	112.34
osteotom, WEST.....	112.31

P

palatal expander, TURVEY.....	114.66
palate plate, KILNER-DOUGHTY.....	114.55
PARKES, rhinoplastic chisel.....	112.37
PENNINGTON, septum elevator.....	112.17
periosteal elevator, OBWEGESER.....	114.68, 114.69
PITHA, mouth gag.....	114.51
PLESTER, flap knife.....	111.26
POLITZER, air bag.....	111.35
POLITZER, connecting nozzle.....	111.35
POLITZER, ear olive.....	111.35
POLITZER, nose olive.....	111.35
POLITZER, rubber bulb.....	111.35
POLITZER, tympanum needle.....	111.23
polypus snares, KRAUSE.....	111.4, 112.7
polypus snares, KRAUSE-VOSS.....	111.4, 112.7
protecting disc.....	111.37
protector, finger, LANGENBECK.....	114.51
punch, antrum.....	113.50
punch, antrum, KERRISON.....	112.2



Index, alphabetical

Q

QUIRE, foreign body lever..... 111.5

R

ramus clamp, STEINHÄUSER..... 114.66
 ramus retractor, OBWEGESER..... 114.74
 ramus separator, SMITH 114.64
 rasp, nasal, FOMON..... 112.24
 rasp, nasal, AUFRICHT 112.20
 rasp, nasal, COTTLE 112.20
 rasp, nasal, FOMON..... 112.22
 rasp, nasal, GALLAHER 112.21
 rasp, nasal, JOSEPH..... 112.21
 rasp, nasal, LEWIS 112.19
 rasp, nasal, MALTZ..... 112.19, 112.24
 rasp, nasal, MASING 112.22
 rasp, nasal, MILLER 112.23
 rasp, nasal, WIENER 112.22
 retractor, channel, OBWEGESER..... 114.73
 retractor, chin, OBWEGESER..... 114.73
 retractor, lip and cheek, BISHOP 114.59
 retractor, lip and cheek, MINNESOTA 114.59
 retractor, lip and cheek, SIMPLEX..... 114.59
 retractor, lip and cheek, STERNBERG 114.59
 retractor, nasal spine, OBWEGESER 114.73, 114.74
 retractor, nasal, AUFRICHT 112.29
 retractor, nasal, AUFRICHT (WALTER)..... 112.29
 retractor, nasal, COTTLE..... 112.27, 112.28
 retractor, nasal, COTTLE-NEIVERT 112.28
 retractor, ramus, OBWEGESER..... 114.73, 114.74
 retractor, soft tissue, OBWEGESER..... 114.72
 retractor, third molar, OBWEGESER..... 114.74
 REYDEL-SEIFFER, tuning fork 111.34
 rhinoplastic chisel, NEIVERT-ANDERSON 112.36
 rhinoplastic chisel, PARKES..... 112.37
 rhinoplastic chisel, SILVER..... 112.36
 rhinoplastic knife, CONVERSE..... 112.10
 rhinoplastic knife, COTTLE..... 112.10
 rhinoplastic knife, FOMON 112.9
 rhinoplastic knife, HALLE 112.11
 rhinoplastic knife, JOSEPH 112.9, 112.10
 rhinoplastic knife, ULRICH 112.11
 rongeur, mastoid, BEYER..... 111.17
 rongeur, mastoid, CITELLI..... 111.17
 rongeur, mastoid, KERRISON 111.18
 ROSEN, micro ear knife 111.26
 ROSEN, micro ear needle 111.24
 ROSER-KÖNIG, mouth gag 114.53
 ROWE, disimpaction forceps 114.63
 rubber bulb, POLITZER..... 111.35
 rubber inserts, YOUNG 114.62
 RUBIN, osteotom 112.35
 RUBIN, septum morselizer 112.41

S

saw, nasal, JOSEPH..... 112.17, 112.18

SCHMIEDEN, nasal forceps..... 113.43
 SCHUKNECHT, sickle knife..... 111.27
 scissors, micro ear, BELLUCCI 111.15
 scoop, ear, GROSS 111.21
 separator, ramus, SMITH 114.64
 septum elevator, BALLENGER..... 112.12
 septum elevator, COTTLE 112.15
 septum elevator, COTTLE 112.15
 septum elevator, FREER..... 112.13, 112.14
 septum elevator, HALLE..... 112.13
 septum elevator, HOWARTH 112.16
 septum elevator, JOSEPH..... 112.13
 septum elevator, JOSEPH-MASING..... 112.12
 septum elevator, KILLIAN..... 112.16, 112.17
 septum elevator, MASING 112.16
 septum elevator, MCKENTY..... 112.12, 112.15
 septum elevator, PENNINGTON..... 112.17
 septum forceps, BRUENINGS..... 113.45
 septum forceps, GRAIG 113.44
 septum forceps, GRAIG-DOMNICK..... 113.45
 septum forceps, JANSEN-MIDDLETON 113.44
 septum forceps, KNIGHT 113.46
 septum forceps, LUC 113.46
 septum morselizer, RUBIN 112.41
 septum straightening forceps, ASCH..... 112.39
 septum straightening forceps, KRESSNER..... 112.40
 septum straightening forceps, WALSHAM..... 112.40
 SEWALL, antrum curette..... 112.30
 SHAPLEIGH, ear curette 111.20
 sickle knife, SCHUKNECHT 111.27
 sickle knife, WULLSTEIN 111.27
 SILVER, rhinoplastic chisel..... 112.36
 SIMPLEX, lip and cheek retractor 114.59
 skin grasping forceps, COTTLE 112.39
 SMITH, ramus separator 114.64
 snare wire 111.4, 112.7
 snare, polypus, KRAUSE..... 111.4, 112.7
 snare, polypus, KRAUSE-VOSS..... 111.4, 112.7
 soft tissue retractor, OBWEGESER..... 114.72
 spare bottle, KABIERSKE..... 111.36
 spatula, tongue, BRÜNINGS..... 114.61
 spatula, tongue, DOYEN 114.61
 specula, ear, HARTMANN 111.2
 specula, ear, TOYNBEE..... 111.2
 specula, ear, ZÖLLNER 111.3
 specula, nasal, BECKMANN 112.3
 specula, nasal, COTTLE..... 112.5
 specula, nasal, HARTMANN-HALLE 112.3
 specula, nasal, KILLIAN 112.4
 specula, nasal, THUDICHUM 112.6
 specula, nasal, VIENNA (WIEN)..... 112.5
 STEINHÄUSER, bone holding forceps 114.64
 STEINHÄUSER, ramus clamp 114.66
 STERNBERG, lip and cheek retractor 114.59
 storage rack 111.3
 STRUEMPEL, ear forceps 111.7

Index, alphabetical

STRUYCKEN, nasal forceps	113.43
suction nozzle.....	111.38
swivel knife, BALLENGER.....	112.11
syringe, ear.....	111.37, 111.38

T

TABB, mucosa knife	111.26
TAKAHASHI, nasal forceps	113.43
TERRY, mylohyoid muscle clamp.....	114.65
TESSIER, osteotom.....	114.76
third molar retractor, OBWEGESER	114.74
threaded tip	111.38
THUDICHUM, nasal specula.....	112.6
TIECK-HALLE, nasal specula.....	112.3
TOBOLD, tongue depressor.....	114.60
tongue depressor, DAVIS-BOYLE	114.57
tongue depressor, DINGMANN	114.56
tongue depressor, HARTMANN.....	114.60
tongue depressor, KILNER-DOUGHTY	114.55
tongue depressor, MCIVOR	114.58
tongue depressor, TOBOLD	114.60
tongue depressor, WIEDER.....	114.60
tongue holding forceps, COLLIN.....	114.62
tongue holding forceps, YOUNG	114.62
tongue spatula, BRÜNINGSS	114.61
tongue spatula, DOYEN	114.61
TOYNBEE, ear specula	111.2
tuning fork	111.34
tuning fork, aluminium	111.33
tuning fork, HARTMANN	111.30, 111.34
tuning fork, HARTMANN / FRENCH.....	111.32
tuning fork, LUCAE.....	111.31, 111.34
tuning fork, RYDEL-SEIFFER	111.34
TURVEY, palatal expander	114.66
tympanum needle, LUCAE.....	111.23
tympanum needle, POLITZER.....	111.23

U

ULRICH, rhinoplastic knife	112.11
----------------------------------	--------

V

valva attachment	111.38
valve rubber bulb, KABIERSKE.....	111.36
VIENNA (WIEN), nasal specula.....	112.5

W

WAGENER, ear hook.....	111.22
WALSHAM, septum straightening forceps.....	112.40
WALTER, chisel	112.34
WALTER, osteotom	112.34
WATSON-WILLIAMS, nasal forceps.....	113.42
WEIL-BLAKESLEY, nasal forceps	113.48, 113.49
WEST, chisel.....	112.31
WEST, osteotom.....	112.31
WESTMACOTT, nasal tampon forceps	112.8
WIEDER, tongue depressor.....	114.60

WIENER, nasal rasp	112.22
wire bending forceps, MCGEE.....	111.14
WULLSTEIN, sickle knife.....	111.27

Y

YOUNG, tongue holding forceps	114.62
YOUNG, rubber inserts	114.62

Z

ZAUFAL, foreign body lever	111.21
ZÖLLNER, ear specula.....	111.3
zygoma elevator, GILLIES	114.63
zygomatic arch awl, OBWEGESER.....	114.75



Indice, alfabético

A

abreboca, DAVIS-BOYLE.....	114.57
abreboca, DENHART.....	114.53
abreboca, DINGMANN.....	114.56
abreboca, HEISTER.....	114.52
abreboca, JENNINGS.....	114.54
abreboca, KILNER-DOUGHTY.....	114.55
abreboca, MAUNDER.....	114.51
abreboca, MCIVOR.....	114.58
abreboca, MOLT.....	114.52
abreboca, ORINGER.....	114.54
abreboca, PITHA.....	114.51
abreboca, ROSER-KÖNIG.....	114.53
adaptador de irrigación.....	111.37
aguja para tímpano, LUCAE.....	111.23
aguja para tímpano, POLITZER.....	111.23
aguja, micro auricular.....	111.25
alambre.....	111.4
aluminium, diapasón.....	111.33
asa de alambre.....	112.7
ASCH, pinza enderezar el tabique nasal.....	112.39
AUFRICHT (WALTER), separador nasal.....	112.29
AUFRICHT, escof na nasal.....	112.20
AUFRICHT, separador nasal.....	112.29

B

bajalengua, DAVIS-BOYLE.....	114.57
bajalengua, DINGMANN.....	114.56
bajalengua, HARTMANN.....	114.60
bajalengua, KILNER-DOUGHTY.....	114.55
bajalengua, MCIVOR.....	114.58
bajalengua, TOBOLD.....	114.60
bajalengua, WIEDER.....	114.60
BALLENGER, cuchillo para tabique nasal.....	112.11
BALLENGER, gubia.....	112.32
BARBARA, micro aguja auricular.....	111.24
BARBARA, micro ganchito auricular.....	111.24
BARTH, cureta auricular.....	111.20
BAUER, osteótomo.....	114.67
BECKMANN, cuchillo para adenoides.....	112.37, 112.38
BECKMANN, espéculos nasales.....	112.3
BELLUCCI, micro tijeras auriculares.....	111.15
BEYER, pinza cortante para huesos.....	111.17
BILLEAU, instrumento para cuerpos extraños.....	111.21
BISHOP, separador para labios y mejillas.....	114.59
bocas de goma, YOUNG.....	114.62
BRÜNING, pinza para tabique nasal.....	113.45
BRÜNING, espátula lingual.....	114.61
BUCK, cureta auricular.....	111.19
BUCK, elevador para cuerpos extraños.....	111.5

C

cánula, KABIERSKE.....	111.36
cincel, FOMON.....	112.35
cincel, FREER.....	112.31
cincel, NEIVERT-ANDERSON.....	112.36

cincel, PARKES.....	112.37
cincel, SILVER.....	112.36
cincel, WALTER.....	112.34
cincel, WEST.....	112.31
CINELLI, osteótomo.....	112.35
CITELLI, pinza cortante para huesos.....	111.17
COAKLEY, cureta para el antro.....	112.30
COLLIN, pinza tira-lengua.....	114.62
cono de conexión, POLITZER.....	111.35
CONVERSE, cuchillo rinoplástico.....	112.10
COTTLE, cuchillo rinoplástico.....	112.10
COTTLE, elevador para tabique nasal.....	112.15
COTTLE, escof na nasal.....	112.20
COTTLE, espéculos nasales.....	112.5
COTTLE, ganchito para alas de nariz.....	112.26
COTTLE, machacadora.....	112.41
COTTLE, mango.....	112.41
COTTLE, osteótomo.....	112.33, 112.34
COTTLE, pinza para columela.....	112.39
COTTLE, pinza para piel.....	112.39
COTTLE, separador nasal.....	112.27, 112.28
COTTLE, soporte de guía.....	112.41
COTTLE-NEIVERT, separador nasal.....	112.28
cucharilla auricular, GROSS.....	111.21
cucharilla, HOUSE.....	111.29
cuchillo de hoz, SCHUKNECHT.....	111.27
cuchillo de hoz, WULLSTEIN.....	111.27
cuchillo para adenoides, BECKMANN.....	112.37, 112.38
cuchillo para lóbulos, PLESTER.....	111.26
cuchillo para mucosa, FREER.....	112.10
cuchillo para mucosa, TABB.....	111.26
cuchillo para rinoplástico, HALLE.....	112.11
cuchillo para rinoplástico, ULRICH.....	112.11
cuchillo para tabique nasal, BALLENGER.....	112.11
cuchillo rinoplástico, CONVERSE.....	112.10
cuchillo rinoplástico, COTTLE.....	112.10
cuchillo rinoplástico, FOMON.....	112.9
cuchillo rinoplástico, JOSEPH.....	112.9, 112.10
cureta auricular, BARTH.....	111.20
cureta auricular, BUCK.....	111.19
cureta auricular, JANSEN.....	111.20
cureta auricular, LANGENBECK.....	111.20
cureta auricular, SHAPLEIGH.....	111.20
cureta para el antro, COAKLEY.....	112.30
cureta para el antro, FAULKNER.....	112.30
cureta para el antro, SEWALL.....	112.30

D

DAVIS-BOYLE, abreboca.....	114.57
DAVIS-BOYLE, bajalengua.....	114.57
DAY, ganchito auricular.....	111.22
dedal, LANGENBECK.....	114.51
DENHART, abreboca.....	114.53
diapasón.....	111.34
diapasón, aluminium.....	111.33
diapasón, HARTMANN.....	111.30, 111.34

Indice, alfabético

diapasón, HARTMANN / FRENCH	111.32
diapasón, LUCAE	111.31, 111.34
diapasón, RYDEL-SEIFFERT	111.34
DIETER, pinza para cabezal del maléolo	111.16
DINGMANN, abreboca	114.56
DINGMANN, bajalengua	114.56
disco protector	111.37
DOYEN, espátula lingual	114.61

E

elevador para cuerpos extraños, BUCK	111.5
elevador para cuerpos extraños, QUIRE	111.5
elevador para tabique nasal, BALLENGER	112.12
elevador para tabique nasal, COTTLE	112.15
elevador para tabique nasal, FREER	112.13, 112.14
elevador para tabique nasal, HALLE	112.13
elevador para tabique nasal, HOWARTH	112.16
elevador para tabique nasal, JOSEPH	112.13
elevador para tabique nasal, JOSEPH-MASING	112.12
elevador para tabique nasal, KILLIAN	112.16, 112.17
elevador para tabique nasal, MASING	112.16
elevador para tabique nasal, MCKENTY	112.12, 112.15
elevador para tabique nasal, PENNINGTON	112.17
elevadores cigomáticos, GILLIES	114.63
elevador para cuerpos extraños, ZAUFAL	111.21
EPKER, osteótomo	114.68
EPKER-BAUER, osteótomo	114.67
escof na nasal, AUFRICHT	112.20
escof na nasal, COTTLE	112.20
escof na nasal, FOMON	112.22, 112.24
escof na nasal, GALLAHER	112.21
escof na nasal, JOSEPH	112.21
escof na nasal, LEWIS	112.19
escof na nasal, MALTZ	112.19, 112.24
escof na nasal, MASING	112.22
escof na nasal, MILLER	112.23
escof na nasal, WIENER	112.22
espátula lingual, BRÜNINGSS	114.61
espátula lingual, DOYEN	114.61
espéculo auriculare, HARTMANN	111.2
espéculo auriculare, TOYNBEE	111.2
espéculo auriculare, ZÖLLNER	111.3
espéculos nasales, BECKMANN	112.3
espéculos nasales, COTTLE	112.5
espéculos nasales, HARTMANN-HALLE	112.3
espéculos nasales, KILLIAN	112.4
espéculos nasales, THUDICHUM	112.6
espéculos nasales, TIECK-HALLE	112.3
espéculos nasales, VIENNA (WIEN)	112.5

F

FAULKNER, cureta para el antro	112.30
FISCH, micro disecadore	111.28
FOMON, cincel	112.35
FOMON, cuchillo rinoplástico	112.9
FOMON, escof na nasal	112.22, 112.24

FOMON, ganchito para alas de nariz	112.26
frasco suelto, KABIIERSKE	111.36
FREER, cincel	112.31
FREER, cuchillo para mucosa	112.10
FREER, elevador para tabique nasal	112.13, 112.14
FREER, gubia	112.32

G

GALLAHER, escof na nasal	112.21
ganchito auricular aguda, HARTMANN	111.21
ganchito auriculare, DAY	111.22
ganchito auriculare, LUCAE	111.22
ganchito auriculare, WAGENER	111.22
ganchito para alas de nariz, COTTLE	112.26
ganchito para alas de nariz, FOMON	112.26
ganchito para alas de nariz, LANGE	112.26
ganchito para mucosa, JOSEPH	112.25
gancho de mentón, OBWEGESER	114.73
GILLIES, elevadores cigomáticos	114.63
GRAIG, pinza para tabique nasal	113.44
GRAIG-DOMNICK, pinza para tabique nasal	113.45
GROSS, cucharilla auricular	111.21
gubia KILLIAN-CLAUS	112.32
gubia, BALLENGER	112.32
gubia, FREER	112.32
gubia, KILLIAN	112.32

H

HAJEK-KOFLER, pinza nasal	113.47
HALLE, cuchillo rinoplástico	112.11
HALLE, elevador para tabique nasal	112.13
HARTMANN / FRENCH, diapasón	111.32
HARTMANN, bajalengua	114.60
HARTMANN, diapasón	111.30, 111.34
HARTMANN, espéculo auriculare	111.2
HARTMANN, ganchito auricular	111.21
HARTMANN, pinza auriculare	111.5- 111.7
HARTMANN, pinza nasal	113.42
HARTMANN, pinza para taponamiento	112.8
HARTMANN, sonda auriculare	111.29
HARTMANN-HALLE, espéculos nasales	112.3
HARTMANN-HOFFMANN, pinza auriculare	111.7
HARTMANN-WULLSTEIN, pinza auriculare	111.6
HEISTER, abreboca	114.52
HOUSE, cucharilla	111.29
HOUSE, micro sonda para medir	111.28
HOWARTH, elevador para tabique nasal	112.16

I

instrumento para cuerpos extraños, BILLEAU	111.21
insuf adore de aire, POLITZER	111.35

J

JANSEN, cureta auriculare	111.20
JANSEN-MIDDLETON, pinza para tabique nasal	113.44
JENNINGS, abreboca	114.54



Indice, alfabético

jeringa auricular	111.37, 111.38
JOSEPH, cuchillo rinoplástico	112.9, 112.10
JOSEPH, elevador para tabique nasal	112.13
JOSEPH, escof na nasal	112.21
JOSEPH, ganchito para mucosa	112.25
JOSEPH, sierra nasal	112.17, 112.18
JOSEPH-MASING, elevador para tabique nasal	112.12

K

KABIERSKE, cánula	111.36
KABIERSKE, frasco suelto	111.36
KABIERSKE, pera de goma	111.36
KABIERSKE, pulverizadore	111.36
KERRISON, pinza cortante para huesos	111.18
KERRISON, pinza para seno maxilar	112.2
KILLIAN, elevador para tabique nasal	112.16, 112.17
KILLIAN, espéculos nasales	112.4
KILLIAN, gubia	112.32
KILLIAN-CLAUS, gubia	112.32
KILNER-DOUGHTY, abreboca	114.55
KILNER-DOUGHTY, bajalengua	114.55
KILNER-DOUGHTY, plaquita paldia	114.55
KNIGHT, pinza para tabique nasal	113.46
KRAUSE, polipótomo	111.4, 112.7
KRAUSE-VOSS, poliopótomo	111.4, 112.7
KRESSNER, pinza enderezar el tabique nasal	112.40

L

LANGE, ganchito para alas de nariz	112.26
LANGENBECK, cureta auriculare	111.20
LANGENBECK, dedal	114.51
LEWIS, escof na nasal	112.19
lezna maxilar, OBWEGESER	114.75
lezna para el arco cigomático, OBWEGESER	114.75
LUBET-BARBON pinza para taponamiento	112.8
LUC, pinza para tabique nasal	113.46
LUCAE, aguja para tímpano	111.23
LUCAE, diapasón	111.31, 111.34
LUCAE, ganchito auriculare	111.22

M

machacadora, COTTLE	112.41
MALTZ, escof na nasal	112.19, 112.24
mango, COTTLE	112.41
MASING, elevador para tabique nasal	112.16
MASING, escof na nasal	112.22
MAUNDER, abreboca	114.51
MCKENTY, elevador para tabique nasal	112.12, 112.15
MC GEE, micro ganchito auriculare	111.25
MC GEE, pinza para plegar alambre	111.14
MCIVOR, abreboca	114.58
MCIVOR, bajalengua	114.58
micro aguja auriculare	111.25
micro aguja auriculare, BARBARA	111.24, 111.25
micro aguja auriculare, ROSEN	111.24
micro cuchillo auriculare, ROSEN	111.26

micro disecadore, FISCH	111.28
micro ganchito auriculare, BARBARA	111.24
micro ganchito auriculare, MCGEE	111.25
micro pinza auriculare	111.9- 111.12
micro pinza auriculare, MINI MCGEE	111.8, 111.13
micro sonda para medir, HOUSE	111.28
micro tijeras auriculares, BELLUCCI	111.15
MILLER, escof na nasal	112.23
MINI MCGEE, micro pinza auriculare	111.8, 111.13
MINNESOTA, separador para labios y mejillas	114.59
mobilizador maxilar, OBWEGESER	114.71
MOLT, abreboca	114.52

N

NEIVERT-ANDERSON, cincel	112.36
--------------------------------	--------

O

OBWEGESER, lezna maxilar	114.75
OBWEGESER, gancho de mentón	114.73
OBWEGESER, lezna para el arco cigomático	114.75
OBWEGESER, mobilizador maxilar	114.71
OBWEGESER, osteótomo	114.70, 114.71
OBWEGESER, periostótomo	114.68, 114.69
OBWEGESER, separador mandibulares	114.73
OBWEGESER, separador para el ramo	114.73, 114.74
OBWEGESER, separador para muela del juicio	114.74
OBWEGESER, separador para partes blandes	114.72
OBWEGESER, separador para spina nasalis	114.73, 114.74
oliva auricular, POLITZER	111.35
oliva nasal, POLITZER	111.35
ORINGER, abreboca	114.54
osteótomo, BAUER	114.67
osteótomo, CINELLI	112.35
osteótomo, COTTLE	112.33, 112.34
osteótomo, EPKER	114.68
osteótomo, EPKER-BAUER	114.67
osteótomo, OBWEGESER	114.70, 114.71
osteótomo, RUBIN	112.35
osteótomo, TESSIER	114.76
osteótomo, WALTER	112.34
osteótomo, WEST	112.31

P

PARKES, cincel	112.37
PENNINGTON, elevador para tabique nasal	112.17
pera de goma, KABIERSKE	111.36
pera de goma, POLITZER	111.35
periostótomo, OBWEGESER	114.69
pieza de succión	111.38
pinza auriculare, HARTMANN	111.5- 111.7
pinza auriculare, HARTMANN-HOFFMANN	111.7
pinza auriculare, HARTMANN-WULLSTEIN	111.6
pinza auriculare, STRUEMPEL	111.7
pinza cortante para huesos, BEYER	111.17
pinza cortante para huesos, CITELLI	111.17
pinza cortante para huesos, KERRISON	111.18

Indice, alfabético

pinza de rama, STEINHÄUSER.....	114.66
pinza enderezar el tabique nasal, ASCH.....	112.39
pinza enderezar el tabique nasal, KRESSNER.....	112.40
pinza enderezar el tabique nasal, WALSHAM.....	112.40
pinza nasal, HAJEK-KOFLER.....	113.47
pinza nasal, HARTMANN.....	113.42
pinza nasal, SCHMIEDEN.....	113.43
pinza nasal, STRUYCKEN.....	113.43
pinza nasal, TAKAHASHI.....	113.43
pinza nasal, WATSON-WILLIAMS.....	113.42
pinza nasal, WEIL-BLAKESLEY.....	113.48, 113.49
pinza para aplastamiento, RUBIN.....	112.41
pinza para cabezal del maléolo, DIETER.....	111.16
pinza para columela, COTTLE.....	112.39
pinza para el músculo milohioideo, TERRY.....	114.65
pinza para huesos, STEINHÄUSER.....	114.64
pinza para piel, COTTLE.....	112.39
pinza para plegar alambre, MCGEE.....	111.14
pinza para reposición, ROWE.....	114.63
pinza para seno maxilar, KERRISON.....	112.2
pinza para separar la rama, SMITH.....	114.64
pinza para tabique nasal, BRÜNNINGS.....	113.45
pinza para tabique nasal, GRAIG.....	113.44
pinza para tabique nasal, GRAIG-DOMNICK.....	113.45
pinza para tabique nasal, JANSEN-MIDDLETON.....	113.44
pinza para tabique nasal, KNIGHT.....	113.46
pinza para tabique nasal, LUC.....	113.46
pinza para taponamiento, HARTMANN.....	112.8
pinza para taponamiento, WESTMACOTT.....	112.8
pinza para taponamiento, LUBET-BARBON.....	112.8
pinza saca-bocada para seno maxilar.....	113.50
pinza tira-lengua, COLLIN.....	114.62
pinza tira-lengua, YOUNG.....	114.62
pinza, micro auricular.....	111.9, 111.12
PITHA, abreboza.....	114.51
plaquita palda, KILNER-DOUGHTY.....	114.55
PLESTER, cuchillo para lóbulos.....	111.26
polipótomo, KRAUSE.....	111.4, 112.7
polipótomo, KRAUSE-VOSS.....	111.4, 112.7
POLITZER, aguja para tímpano.....	111.23
POLITZER, cono de conexión.....	111.35
POLITZER, insuf adore de aire.....	111.35
POLITZER, oliva auricular.....	111.35
POLITZER, oliva nasal.....	111.35
POLITZER, pera de goma.....	111.35
pulverizadore, KABIERSKE.....	111.36

Q

QUIRE, elevador para cuerpos extraños.....	111.5
--	-------

R

ROSEN, micro aguja auricular.....	111.24
ROSEN, micro cuchillo auricular.....	111.26
ROSER-KÖNIG, abreboza.....	114.53
ROWE, pinza para reposición.....	114.63
RUBIN, osteótomo.....	112.35

RUBIN, pinza para aplastamiento.....	112.41
RYDEL-SEIFFER, diapasón.....	111.34

S

SCHMIEDEN, pinza nasal.....	113.43
SCHUKNECHT, micro cuchillo auricular.....	111.27
separador mandibulares, OBWEGESER.....	114.73
separador nasal, AUFRICHT.....	112.29
separador nasal, AUFRICHT (WALTER).....	112.29
separador nasal, COTTLE.....	112.27, 112.28
separador nasal, COTTLE-NEIVERT.....	112.28
separador para el ramo, OBWEGESER.....	114.73, 114.74
separador para labios y mejillas, BISHOP.....	114.59
separador para labios y mejillas, MINNESOTA.....	114.59
separador para labios y mejillas, SIMPLEX.....	114.59
separador para labios y mejillas, STERNBERG.....	114.59
separador para muela del juicio, OBWEGESER.....	114.74
separador para partes blandas, OBWEGESER.....	114.72
separador para spina nasalis, OBWEGESER.....	114.73, 114.74
separator paladial, TURVEY.....	114.66
SEWALL, cureta para el antro.....	112.30
SHAPLEIGH, cureta auricular.....	111.20
sierra nasal, JOSEPH.....	112.17, 112.18
SILVER, cincel.....	112.36
SIMPLEX, separador para labios y mejillas.....	114.59
SMITH, pinza para separar la rama.....	114.64
sonda auricular, HARTMANN.....	111.29
soporte.....	111.3
soporte de guía, COTTLE.....	112.41
STEINHÄUSER, pinza de rama.....	114.66
STEINHÄUSER, pinza para huesos.....	114.64
STERNBERG, separador para labios y mejillas.....	114.59
STRUEMPPEL, pinza auricular.....	111.7
STRUYCKEN, pinza nasal.....	113.43

T

TABB, cuchillo para mucosa.....	111.26
TAKAHASHI, pinza nasal.....	113.43
TERRY, pinza para el músculo milohioideo.....	114.65
TESSIER, osteótomo.....	114.76
THUDICHUM, espéculos nasales.....	112.6
TIECK-HALLE, espéculos nasales.....	112.3
TOBOLD, bajalengua.....	114.60
TOYNBEE, espéculo auricular.....	111.2
tubo de conexión.....	111.38
TURVEY, separator paladial.....	114.66

U

ULRICH, cuchillo rinoplástico.....	112.11
------------------------------------	--------

V

válvula de conexión.....	111.38
VIENNA (WIEN), espéculos nasales.....	112.5

W

WAGENER, gancho auricular.....	111.22
--------------------------------	--------



Indice, alfabético

WALSHAM, pinza enderezar el tabique nasal.....	112.40
WALTER, cincel.....	112.34
WALTER, osteótomo.....	112.34
WATSON-WILLIAMS, pinza nasal.....	113.42
WEIL-BLAKESLEY, pinza nasal.....	113.48, 113.49
WEST, cincel.....	112.31
WEST, osteótomo.....	112.31
WESTMACOTT, pinza para taponamiento.....	112.8
WIEDER, bajalengua.....	114.60
WIENER, escof na nasal.....	112.22
WULLSTEIN, micro cuchillo auriculare.....	111.27

Y

YOUNG, bocas de goma.....	114.62
YOUNG, pinza tira-lengua.....	114.62

Z

ZAUFAL, elevador para cuerpos extraños.....	111.21
ZÖLLNER, espéculo auriculare.....	111.3