

rib spreaders

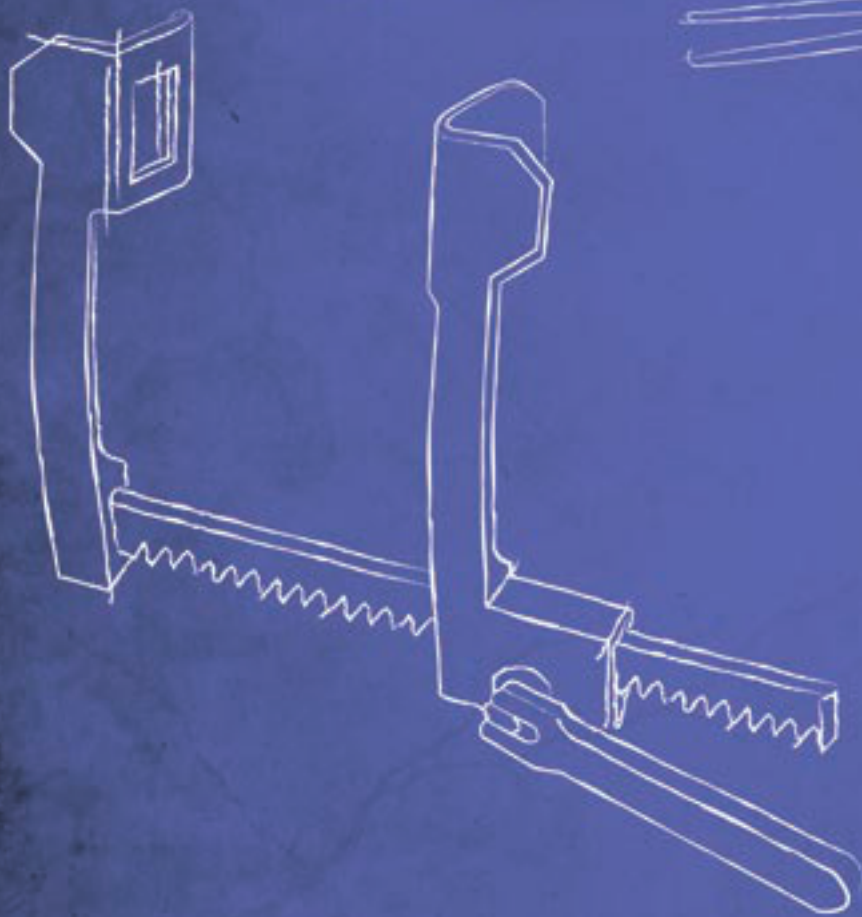

clamps



Herz- u. Gefäßchirurgie
Cardiovascular Surgery

140

Rippenscheren
Rib Shears



Art.Nr.	Beschreibung Description	Size	Spez.
140-012-23	Knochenschere Bone Shears	23,0cm; 9"	



140-013-22		23,0cm; 9"	
------------	--	------------	--



140-015-22	GLUCK ziehender Schnitt drawing cut	21,0cm; 8 2/8"	
------------	----------------------------------------	----------------	--



Rippenscheren
Rib Shears

Art.Nr.	Beschreibung Description	Size	Spez.
140-022-34	BETHUNE	34,5cm; 13 5/8"	



140-023-26	SAUERBRUCH	26,0cm; 10 2/8"	
------------	------------	-----------------	--



140-030-27	GIERTZ-STILLE	24,5cm; 9 5/8"	
------------	---------------	----------------	--



Rippenscheren, Sternummeißel
 Rib Shears, Sternum Chisel

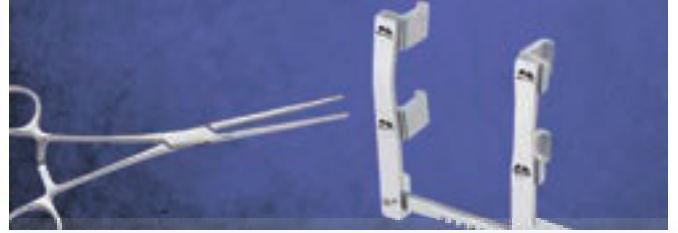

Art.Nr.	Beschreibung Description	Size	Spez.
	BRUNNER	32,0cm; 12 5/8"	



140-041-32 für die rechte Hand
 for right hand

140-043-32 für die linke Hand
 for left hand

140-080-25	LEBSCHE	24,5cm; 9 5/8"
------------	---------	----------------



Art.Nr. Beschreibung | Description Size Spez.

COOLEY ALUMINIUM

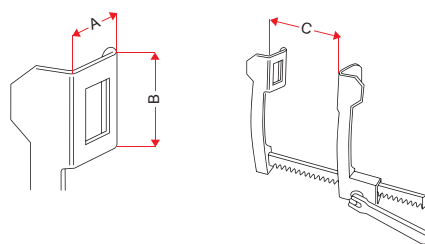

140-130-01AL für Erwachsene | for adults

A	B	C
35 mm	50 mm	200 mm

140-130-03AL für Kinder | for children

15 mm	30 mm	140 mm
-------	-------	--------

140-130-02AL für Kinder | for children

21 mm	44 mm	150 mm
-------	-------	--------

140-130-04AL für Säuglinge | for babies

12 mm	16 mm	95 mm
-------	-------	-------

FINOCHIETTO INFANT ALUMINIUM

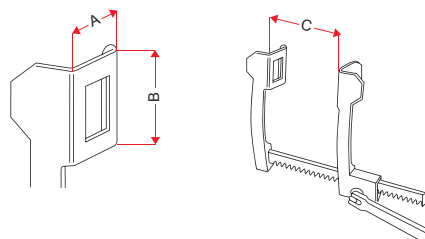

140-100-01AL für Säuglinge | for babies

A	B	C
18 mm	20 mm	75 mm

Rippensperrer
Rib Spreaders



Art.Nr. Beschreibung | Description Size Spez.

FINOCHIETTO BABY ALUMINIUM

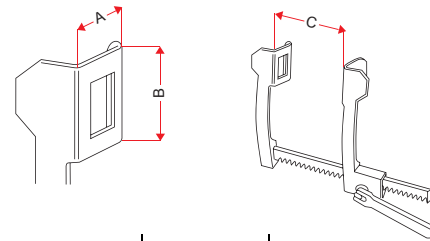

140-106-01AL für Kinder | for children

A	B	C
31 mm	31 mm	100 mm

FINOCHIETTO ALUMINIUM

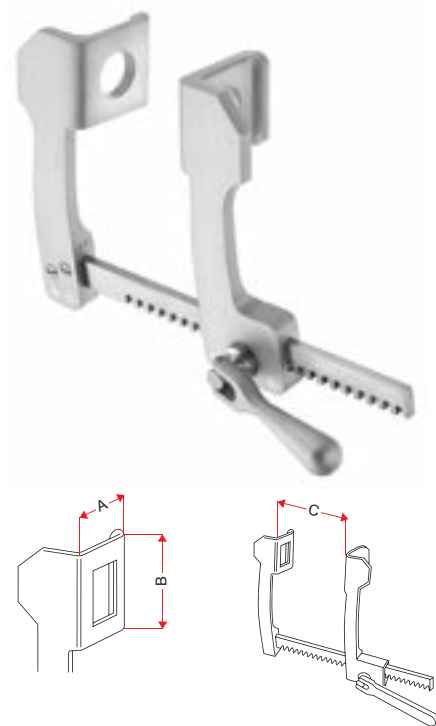

	A	B	C
140-104-01AL	30 mm	45 mm	140 mm
140-104-02AL	40 mm	65 mm	175 mm
140-104-03AL	85 mm	65 mm	175 mm

140

Rippensperrer
Rib Spreaders

Art.Nr. Beschreibung | Description Size Spez.

BURFORD ALUMINIUM

mit 2 Paar Valven | with 2 pairs of blades

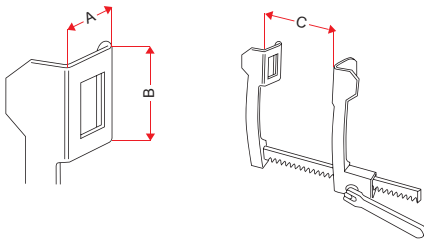

	A1 / B1	A2 / B2	C
140-140-01AL	47 / 62 mm	65 / 62 mm	200 mm
140-140-02AL	47 / 62 mm	65 / 62 mm	260 mm
140-140-03AL	47 / 62 mm	65 / 62 mm	300 mm

Rippensperrer
Rib Spreaders

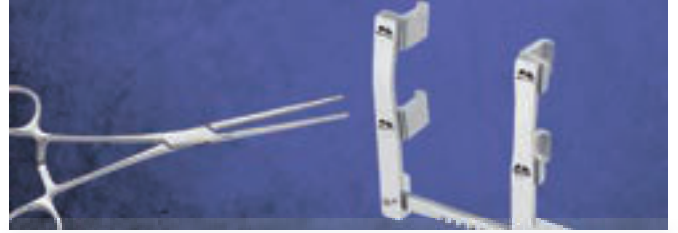

Art.Nr. Beschreibung | Description Size Spez.

CASTAÑEDA ALUMINIUM

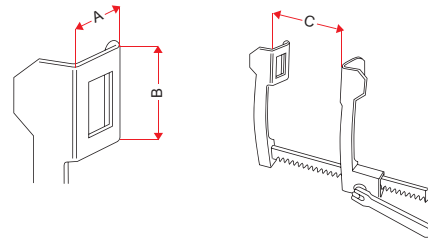

140-135-03AL für Säuglinge | for babies

A	B	C
---	---	---

10 mm	32 mm	65 mm
-------	-------	-------

140-135-02AL für Kleinkinder | for infants

12 mm	45 mm	75 mm
-------	-------	-------

140-135-01AL für Kleinkinder | for infants

15 mm	60 mm	100 mm
-------	-------	--------

HAIGHT

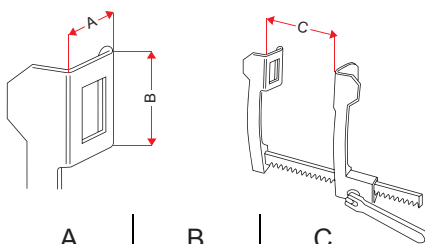

140-110-00

A	B	C
30 mm	30 mm	120 mm

140

Art.Nr. Beschreibung | Description Size Spez.

MORSE FAVALORO ALUMINIUM

mit 4 beweglichen Valven | with 4 moveable blades

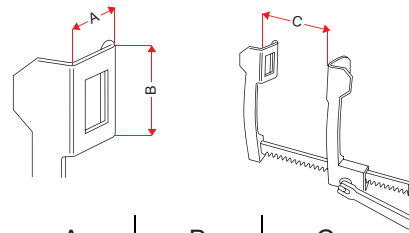

A	B	C
17 mm	22 mm	160 mm

140-114-02AL für Kinder | for children

MORSE FAVALORO

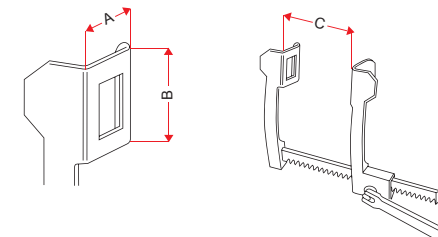

A	B	C
22 mm	27 mm	200 mm

140-114-01 für Erwachsene | for adults

Rippensperrer
Rib Spreaders



Art.Nr. Beschreibung | Description Size Spez.

TUFFIER

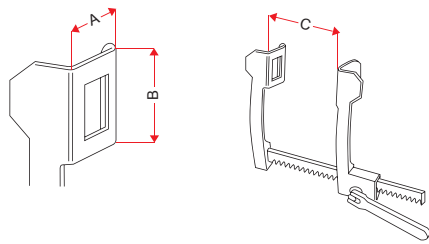

	A	B	C
140-150-01	45 mm	45 mm	165 mm

Rippensperrer
Rib Spreaders

Art.Nr. Beschreibung | Description Size Spez.

FINOCCHIETTO-BABY

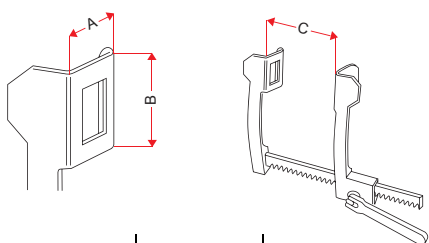

	A	B	C
140-100-01	18 mm	20 mm	75 mm

FINOCCHIETTO

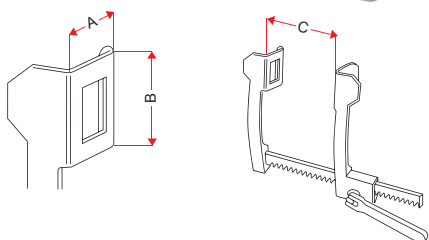

	A	B	C
140-100-02	30 mm	45 mm	150 mm
140-100-03	45 mm	65 mm	190 mm
140-100-04	80 mm	65 mm	190 mm

Rippensperrer
Rib Spreaders



Art.Nr. Beschreibung | Description Size Spez.

DE BAKEY



140-122-00

mit 3 Paar Valven
with 3 pairs of blades

140-122-10

Sperrer allein
Retractor only

Seitenvalven
Lateral Blades

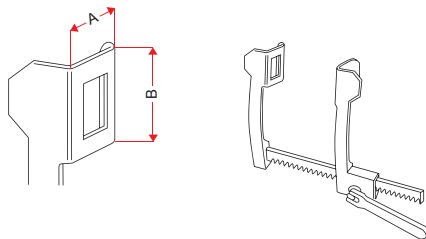

140-122-01

Fig. 1

	A	B
Fig. 1	30 mm	30 mm
Fig. 2	40 mm	40 mm
Fig. 3	50 mm	50 mm

140-122-02

Fig. 2

140-122-03

Fig. 3

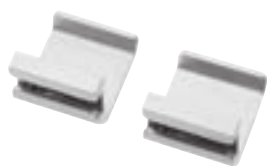

140-122-01



140-122-02

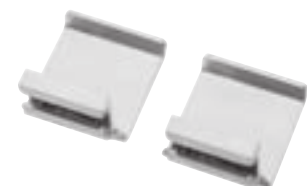

140-122-03

140

Rippensperrer
Rib Spreaders

Art.Nr.	Beschreibung Description	Size	Spez.
	DE BAKEY 		
140-120-00	mit 3 Paar Valven with 3 pairs of blades	140-120-10	Sperrer allein Retractor only

Seitenvalven
Lateral Blades

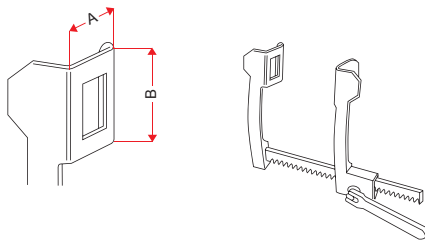

		A	B
140-120-01	Fig. 1	60 mm	60 mm
140-120-02	Fig. 2	50 mm	80 mm
140-120-03	Fig. 3	40 mm	100 mm
140-120-04	Fig. 4	80 mm	60 mm
140-120-05	Fig. 5	50 mm	66 mm



140-120-01

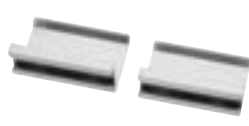

140-120-02



140-120-03

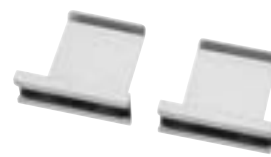

140-120-04



140-120-05

Thoraxsperrer
Thoracic Retractor

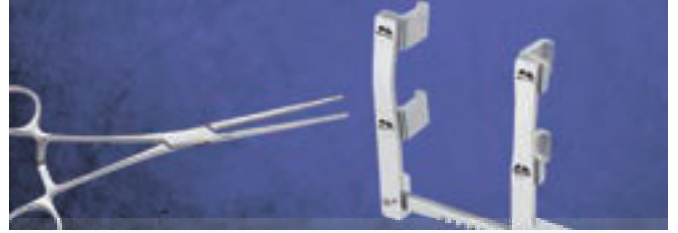

Art.Nr. Beschreibung | Description Size Spez.

MERCEDES



140-145-00 mit je 1 Paar Valven
with 1 pair of blades each

140-145-01 Sperrer allein
Retractor only

Seitenvalven; Paar
Lateral Blades; pair

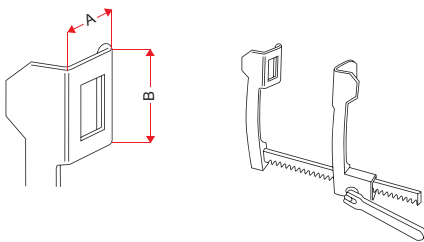

140-145-65
140-145-75

	A	B
Fig. 1	48 mm	68 mm
Fig. 2	70 mm	75 mm



140-145-65



140-145-75

140

Rippenkontraktoren
Rib Contractors

Art.Nr.	Beschreibung Description	Size	Spez.
140-310-19	SELLORS	20,0cm; 7 7/8"	

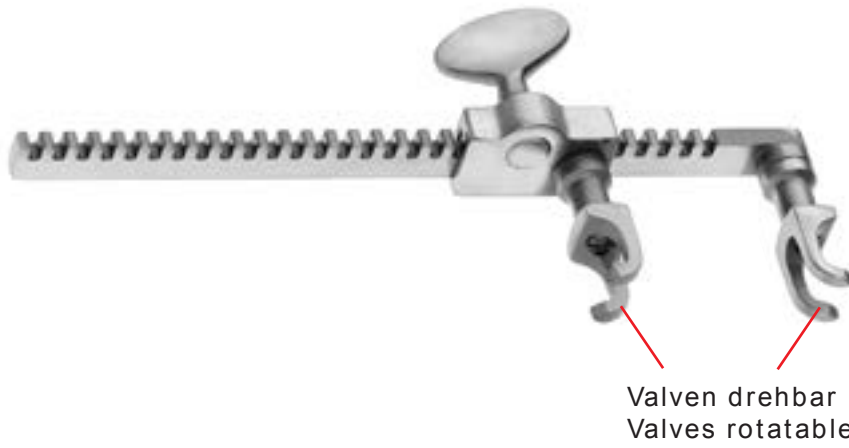

140-318-14	BAILEY-BABY	15,5cm; 6 1/8"	
------------	-------------	----------------	--



Rippenkontraktoren
Rib Contractors

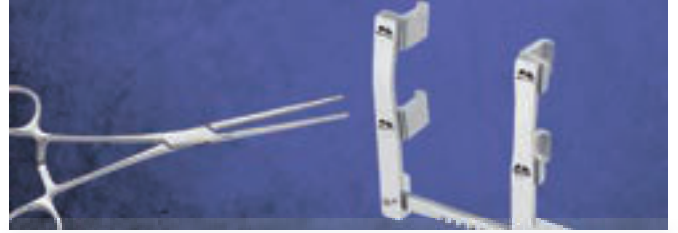

Art.Nr.	Beschreibung Description	Size	Spez.
140-320-16	BAILEY kurze Klauen short claws	20,0cm; 7 7/8"	



140-326-16	BAILEY-GIBBON lange Klauen long claws	20,cm; 7 7/8"	
------------	------------------------------------------	---------------	--



Weitere Artikel
further items

Art.Nr.	Beschreibung Description	Size	Spez.
Other items available but not illustrated			
140-025-35 140-027-35	CORYLLOS rib shears left right	35,0cm; 13,8"	
140-033-36	SAUERBRUCH-FREY rib shears	36,0cm; 14,2"	
140-036-25	LEBSCHE sternum shears	25,0cm; 10"	
140-107-00 140-107-05 140-107-10 140-108-00	FINOCHIETOO-BURFORD rib spreader with changeable Valves 60X60; spreading up to 200mm with changeable Valves 60X60; spreading up to 250mm with changeable Valves 60X60; spreading up to 300mm with changeable Valves; spreading up to 250mm		
140-114-01AL	MORSE FAVALORO; Rib Spreader; ALU for adults; Valve 20x28; spreading 200mm		
140-114-02	MORSE FAVALORO; Rib Spreader for children; stainless steel; Valves 20x20; spreading 160mm		
140-140-04AL	BURFORD rib spreader; 48x42x135		
140-152-10	HERTZLER rib spreader; 20x25mm		

rib spreaders

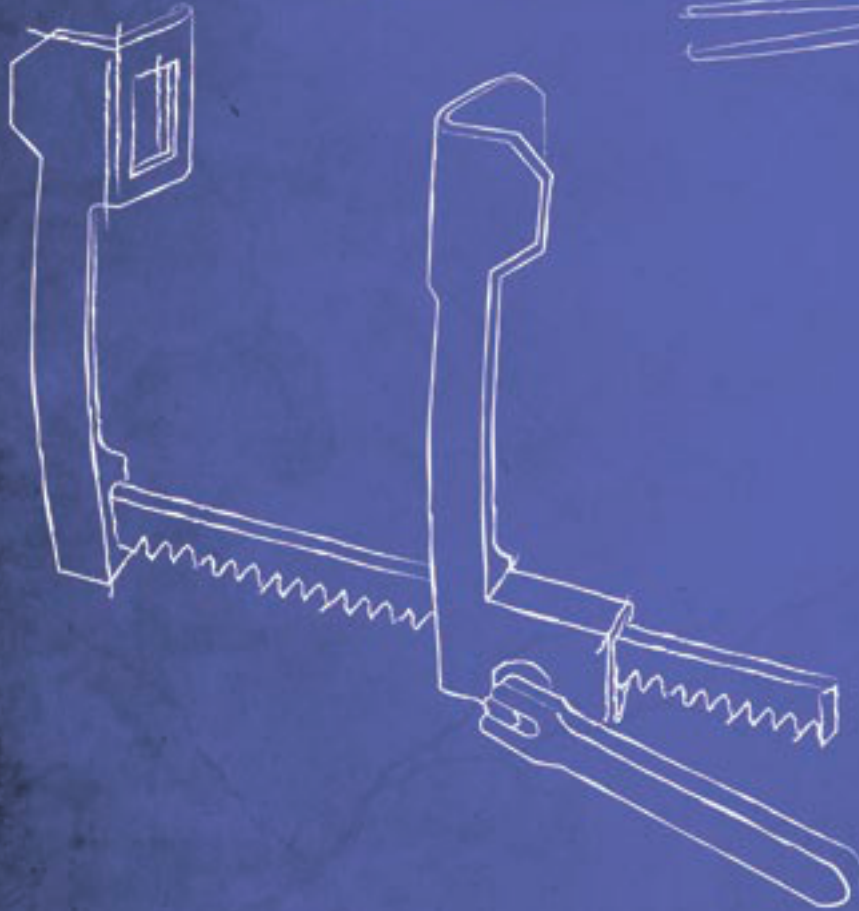

clamps



Herz- u. Gefäßchirurgie
Cardiovascular Surgery

141

Bronchusklemmen
Bronchus Clamps



Art.Nr.	Beschreibung Description	Size	Spez.
---------	----------------------------	------	-------

141-001-22

PRICE - THOMAS

22,0cm; 8 5/8"

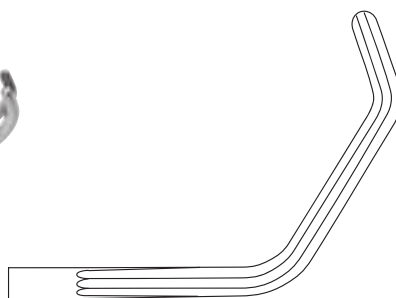

PRICE - THOMAS

22,0cm; 8 5/8"

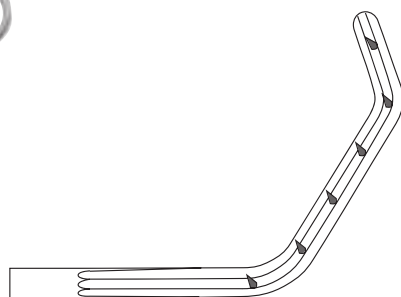

141-002-01

Fig. 1

141-002-02

Fig. 2

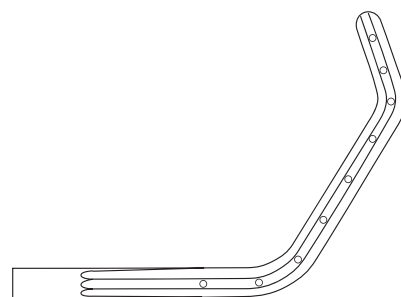

SEMB

25,0cm; 9 7/8"



141-003-01

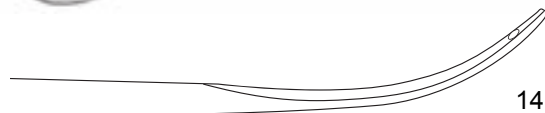

141-003-02

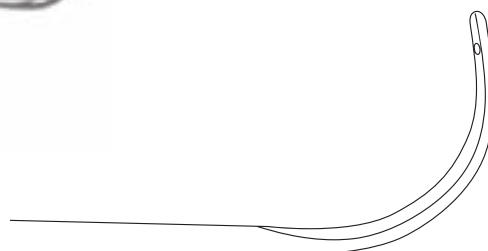

141

Lungenfasszangen
Lung Grasping Forceps

Art.Nr.	Beschreibung Description	Size	Spez.
141-004-20	LOVELACE	20,5cm; 8 1/8"	

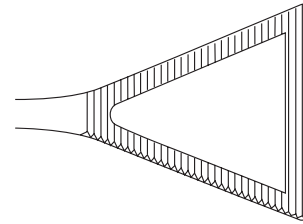

141-005-20	LOVELACE	19,0cm; 7 4/8"	
------------	----------	----------------	--

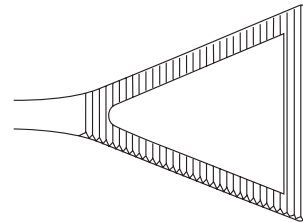

Fadenfänger; Tourniquets
 Ligature catchers; Tourniquets





Art.Nr.	Beschreibung Description	Size	Spez.
		26,0cm; 10 2/8"	

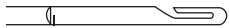

141-028-15  Ø 1,5 mm

141-028-20  Ø 2,0 mm

141-028-25  Ø 2,5 mm

141-028-30  Ø 3,0 mm

RUMEL-BELMONT



141-030-32 Ø 4,2 mm 27,0cm; 10 5/8









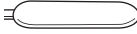

141-030-64 Ø 8,8 mm 30,5cm; 12"

141

Gefäßdilatoren
Vascular Dilators

Art.Nr.	Beschreibung Description	Size	Spez.
	DE BAKEY	19,0cm; 7 4/8"	

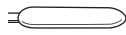

141-304-05	Ø 0,5 mm 	141-304-35	Ø 3,5 mm 
141-304-10	Ø 1,0 mm 	141-304-40	Ø 4,0 mm 
141-304-15	Ø 1,5 mm 	141-304-45	Ø 4,5 mm 
141-304-20	Ø 2,0 mm 	141-304-50	Ø 5,0 mm 
141-304-25	Ø 2,5 mm 	141-304-70	Ø 7,0 mm 
141-304-30	Ø 3,0 mm 	141-304-90	Ø 9,0 mm 



Art.Nr.	Beschreibung Description	Size	Spez.
	COOLEY	13,0cm; 5,2"	



141-316-05	Ø 0,5 mm		141-316-25	Ø 2,5 mm	
141-316-10	Ø 1,0 mm		141-316-30	Ø 3,0 mm	
141-316-15	Ø 1,5 mm		141-316-40	Ø 4,0 mm	
141-316-20	Ø 2,0 mm		141-316-50	Ø 5,0 mm	

Weitere Artikel
further items

Art.Nr.	Beschreibung Description	Size	Spez.
Other items available but not illustrated			
141-007-01 141-007-02	SATINSKY vena cava forceps fig. 1 fig. 2		
141-008-15	BABY-SATINSKY vena cava forceps		
141-009-01 141-009-02 141-009-03	HARKEN vena cava forceps fig. 1 fig. 2 fig. 3		
141-020-42	TUBBS Dilator		
141-022-15 141-022-42 141-026-40	COOLEY Dilator for children; shaft 13,0cm, spreading 8-15mm for adults; shaft 16,0cm, spreading 9,5-42mm for children; curved, spreading 4-10mm		
141-210-38 141-210-48 141-210-58 141-210-78 141-211-38	tunneling forceps straight straight straight straight curved	38,0cm; 15" 48,0cm; 18,9" 58,0cm; 22,8" 78,0cm; 30,7" 38,0cm; 15"	
141-304-00	DE BAKEY vascular dilators Set of 12; flexible; Ø 0,5mm - 9,0mm	19,0cm; 7,6"	
141-306-05 141-306-10 141-306-15 141-306-20 141-306-25 141-306-30 141-306-35 141-306-40 141-306-45 141-306-50 141-306-70 141-306-90	DE BAKEY vascular dilators flexible; Ø 0,5mm flexible; Ø 1,0mm flexible; Ø 1,5mm flexible; Ø 2,0mm flexible; Ø 2,5mm flexible; Ø 3,0mm flexible; Ø 3,5mm flexible; Ø 4,0mm flexible; Ø 4,5mm flexible; Ø 5,0mm flexible; Ø 7,0mm flexible; Ø 9,0mm	35,0cm; 14"	
141-310-10 141-310-15 141-310-20 141-310-25 141-310-30 141-310-35 141-310-40 141-310-45	GARRETT vascular dilators flexible; Ø 1,0mm flexible; Ø 1,5mm flexible; Ø 2,0mm flexible; Ø 2,5mm flexible; Ø 3,0mm flexible; Ø 3,5mm flexible; Ø 4,0mm flexible; Ø 4,5mm	14,0cm; 5,6"	
141-310-50 141-312-10 141-312-15 141-312-20 141-312-25 141-312-30 141-312-35 141-312-40 141-312-45 141-312-50	flexible; Ø 5,0mm flexible; Ø 1,0mm flexible; Ø 1,5mm flexible; Ø 2,0mm flexible; Ø 2,5mm flexible; Ø 3,0mm flexible; Ø 3,5mm flexible; Ø 4,0mm flexible; Ø 4,5mm flexible; Ø 5,0mm	21,0cm; 8,4"	

rib spreaders

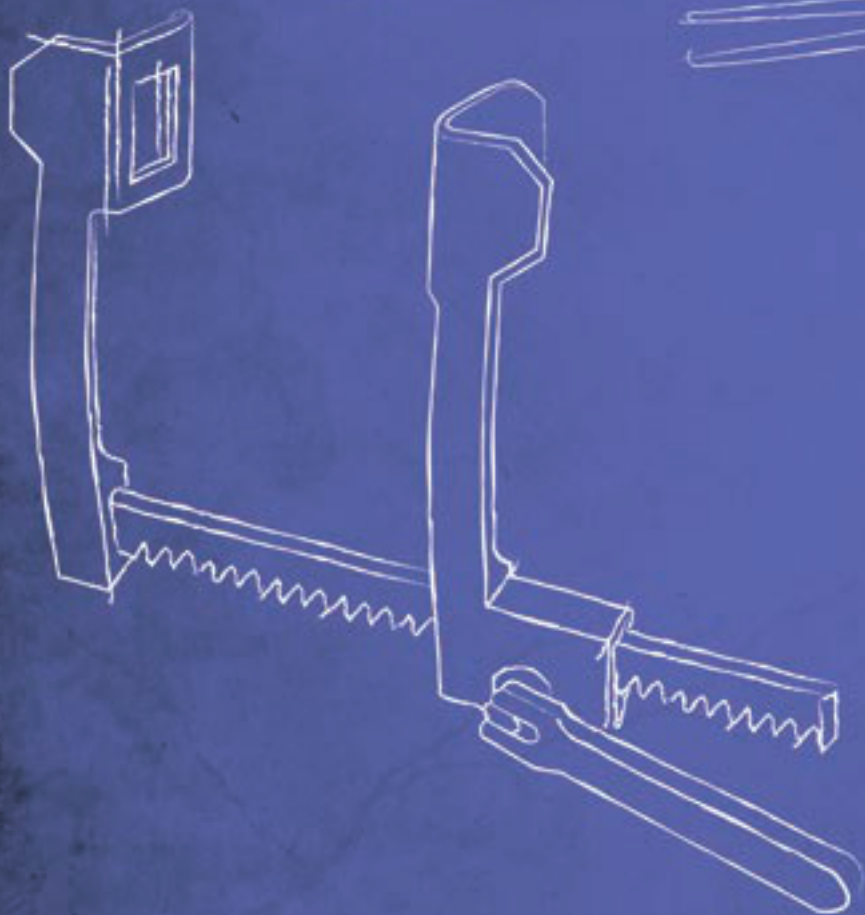

clamps



Herz- u. Gefäßchirurgie
Cardiovascular Surgery

142

Arterienklemmen
Haemostatic Forceps



Art.Nr.	Beschreibung Description	Size	Spez.
DE BAKEY-RANKIN			
16,0cm; 6 2/8"			
<div style="border: 1px solid black; padding: 2px; display: inline-block;"> ATRAUMA </div>			
142-000-16		142-001-16	
DE BAKEY-MOSQUITO			
15,0cm; 5 7/8"			
<div style="border: 1px solid black; padding: 2px; display: inline-block;"> ATRAUMA </div>			
142-002-15		142-003-15	

142

Aortaklemmen
Aortic Clamps

Art.Nr.	Beschreibung Description	Size	Spez.
142-010-23	OCHSNER	22,0cm; 8 5/8"	ATRAUMA

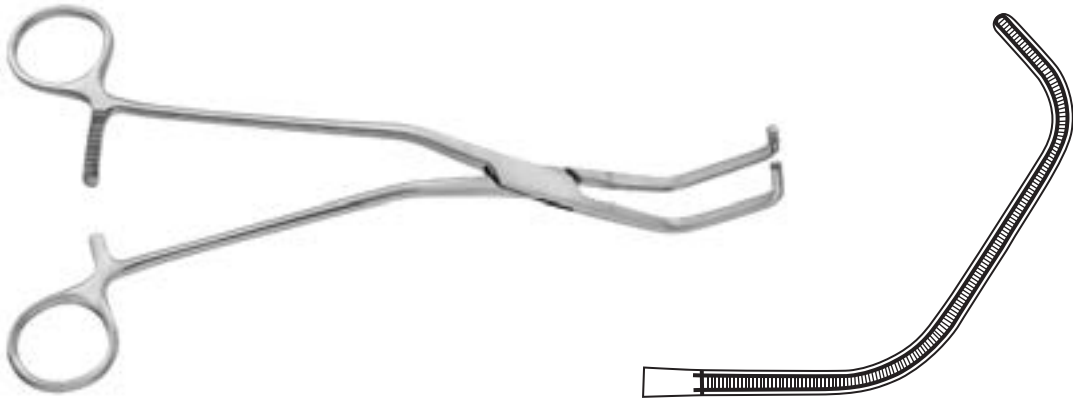

142-015-21	DIETRICH	22,0cm; 8 5/8"	ATRAUMA
------------	----------	----------------	---------



Mehrzweck-Gefäßklemmen
Multi purpose Vascular Clamps

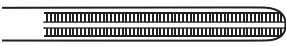
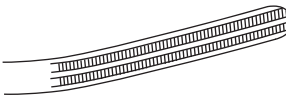
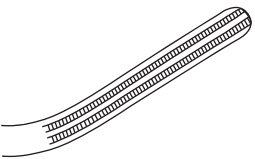
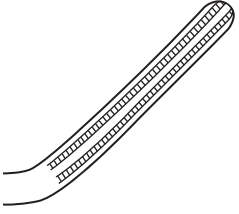
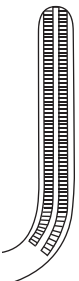
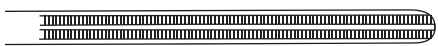
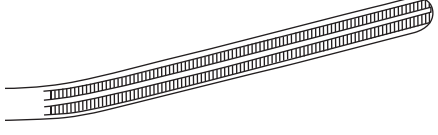
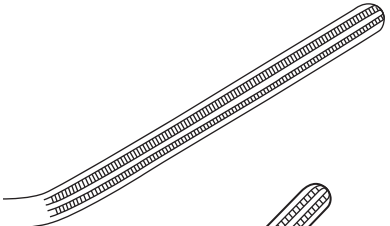
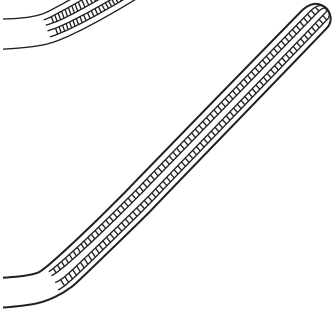
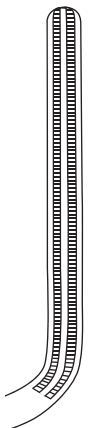

Art.Nr.	Beschreibung Description	Size	Spez.
	DARDIK 		ATRAUMA
142-020-00		15,0cm; 5 7/8"	
142-020-15	15° 	15,5cm; 6 1/8"	
142-020-30	30° 	15,5cm; 6 1/8"	
142-020-45	45° 	15,0cm; 5 7/8"	
142-020-90	90° 	13,5cm; 5 3/8"	
142-022-00		17,0cm; 6 6/8"	
142-022-15	15° 	16,5cm; 6 4/8"	
142-022-30	30° 	16,5cm; 6 4/8"	
142-022-45	45° 	17,0cm; 6 6/8"	
142-022-90	90° 	13,5cm; 5 3/8"	

142

Peripheral-Gefäßklemmen
Peripheral Vascular Clamps

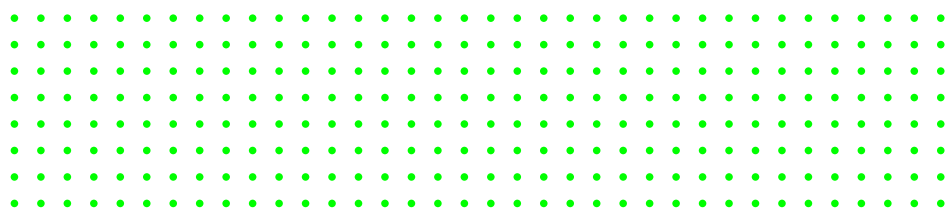

Art.Nr.	Beschreibung Description	Size	Spez.
---------	----------------------------	------	-------

142-025-18	DALE	18,0cm; 7 1/8"	<div style="border: 1px solid green; padding: 2px; display: inline-block;"> ATRAUMA </div>
------------	------	----------------	------------------------------------------------------------------------------------------------------------------

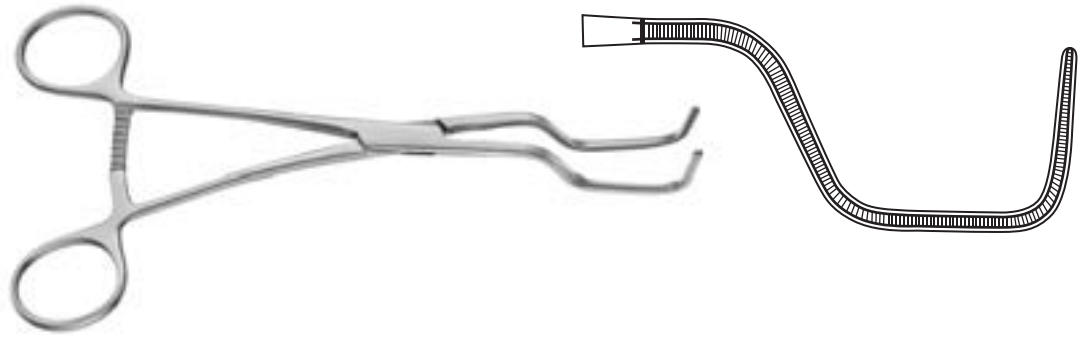

	DALE		<div style="border: 1px solid green; padding: 2px; display: inline-block;"> ATRAUMA </div>
--	------	--	------------------------------------------------------------------------------------------------------------------



142-030-17	17,5cm; 6 7/8"	
142-030-18	18,0cm; 7 1/8"	
142-030-19	18,5cm; 7 2/8"	

Profundaklemmen
Profunda Clamps



Art.Nr.	Beschreibung Description	Size	Spez.
---------	----------------------------	------	-------

GREGORY

ATRAUMA



142-035-14	13,5cm; 5 3/8"	
142-035-16	16,0cm; 6 2/8"	
142-035-18	18,0cm; 7 1/8"	

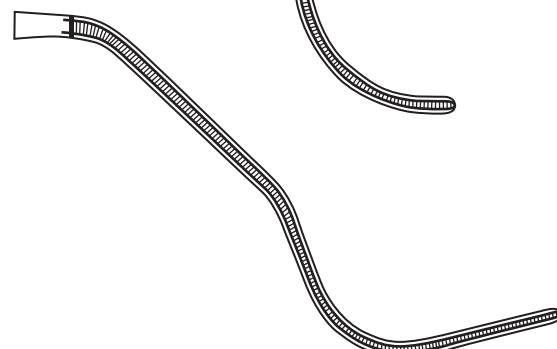
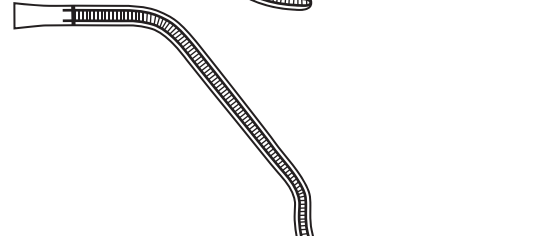
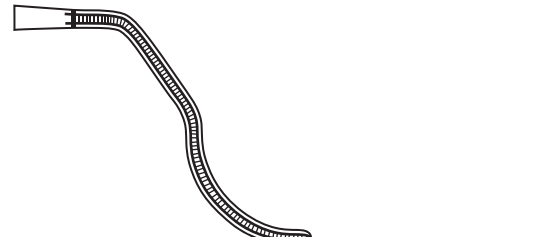

142

Carotis-Shuntklemmen
Carotid Shunt Clamps

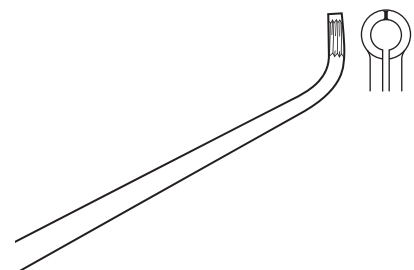
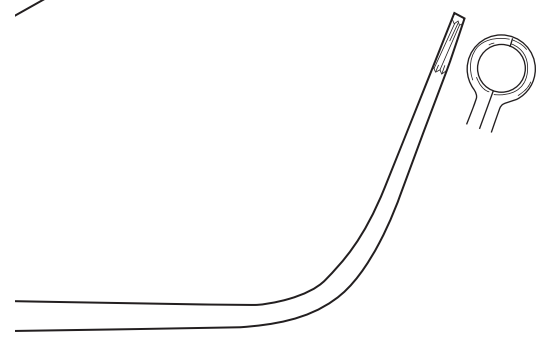
Art.Nr.	Beschreibung Description	Size	Spez.
	<p>JAVID</p> 		<p>ATRAUMA</p>
142-040-18	<p>17,5cm; 6 7/8"</p> 		
142-040-19	<p>18,5cm; 7 2/8"</p> 		

Peripheral-Gefäßklemmen
Peripheral Vascular Clamps



Art.Nr.	Beschreibung Description	Size	Spez.
---------	----------------------------	------	-------

MARTIN

ATRAUMA



142-050-16	16,0cm; 6 2/8"		
------------	----------------	--	--

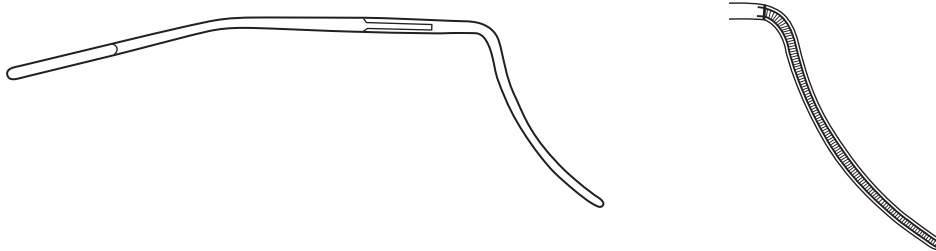

142-050-17	17,0cm; 6 6/8"		
------------	----------------	--	--

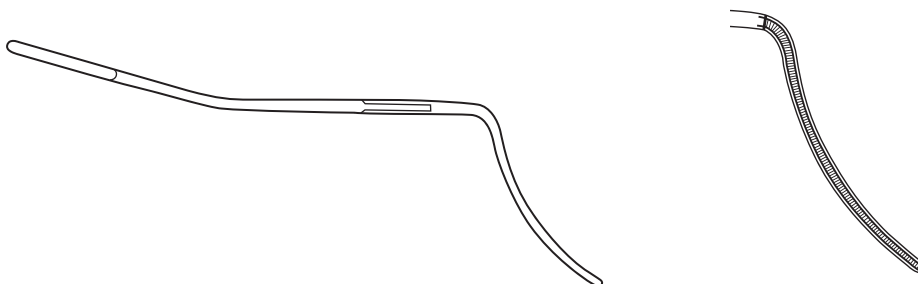

142

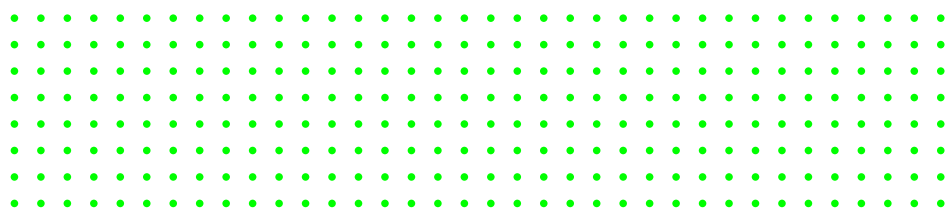

Art.Nr.	Beschreibung Description	Size	Spez.
---------	----------------------------	------	-------

MARTIN

ATRAUMA



142-050-18	18,0cm; 7 1/8"		
------------	----------------	--	--

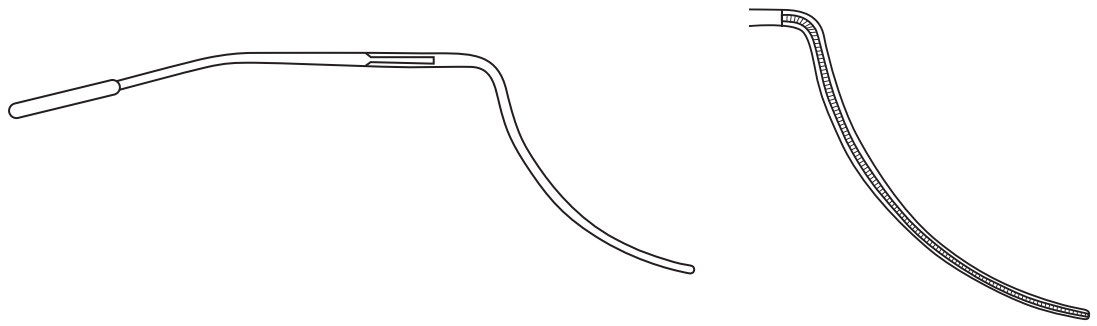

142-050-20	19,5cm; 7 5/8"		
------------	----------------	--	--

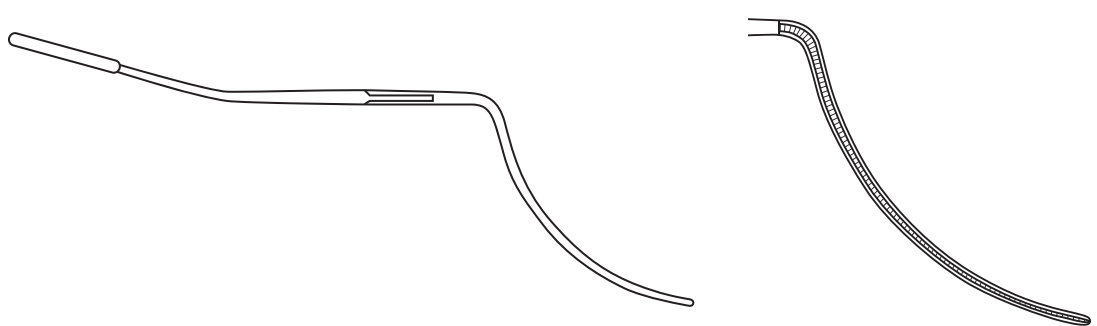

Katheterklemmen
Catheter Clamps



Art.Nr.	Beschreibung Description	Size	Spez.
---------	----------------------------	------	-------

COOLEY

ATRAUMA

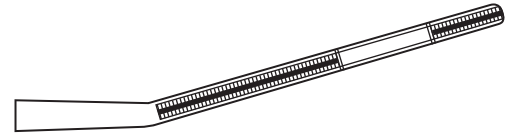

142-060-24

24 Charr.

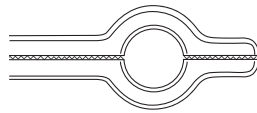

17,0cm; 6 6/8"

142-060-26

26 Charr.

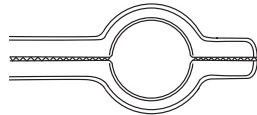

142-060-28

28 Charr.

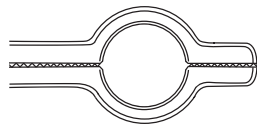

20,0cm; 7 7/8"

142-060-30

30 Charr.

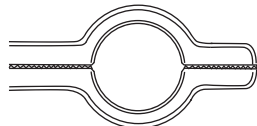





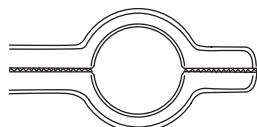

142-060-32

32 Charr.



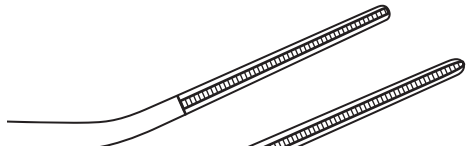

142

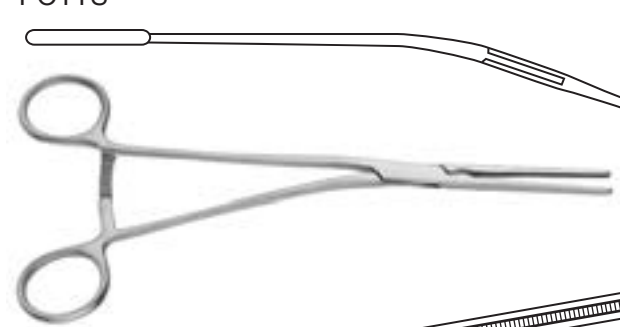
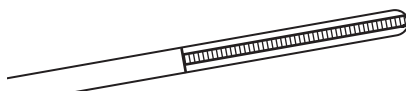
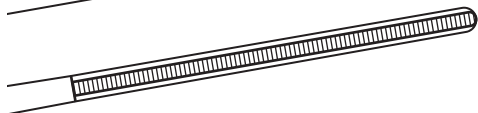
Coarctationsklemmen
Coarctation Clamps

Art.Nr.	Beschreibung Description	Size	Spez.
	<p>POTTS</p> 		<div style="border: 1px solid black; padding: 2px; display: inline-block;"> ATRAUMA </div>
142-080-21	21,0cm; 8 2/8" 		
142-080-22	22,5cm; 8 7/8" 		
	<p>POTTS</p> 		<div style="border: 1px solid black; padding: 2px; display: inline-block;"> ATRAUMA </div>
142-081-21	20,5cm; 1/8" 		
142-081-22	22,0cm; 8 5/8" 		
	<p>POTTS</p> 		<div style="border: 1px solid black; padding: 2px; display: inline-block;"> ATRAUMA </div>
142-083-21	20,5cm; 8" 		
142-083-22	22,0cm; 8 6/8" 		

Anastomosenklemmen
Anastomosis Clamps

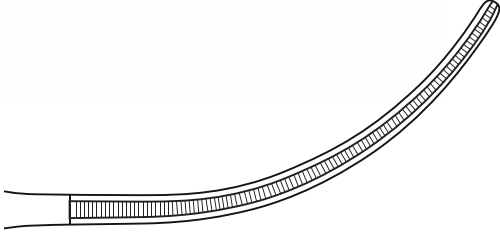

Art.Nr.	Beschreibung Description	Size	Spez.
	POTTS		ATRAUMA
142-085-22	21,5cm; 8 4/8" 		
142-087-22	22,0cm; 8 5/8" 		

DE BAKEY Präparier- und Ligaturklemme
Dissecting and Ligature Forceps

ATRAUMA

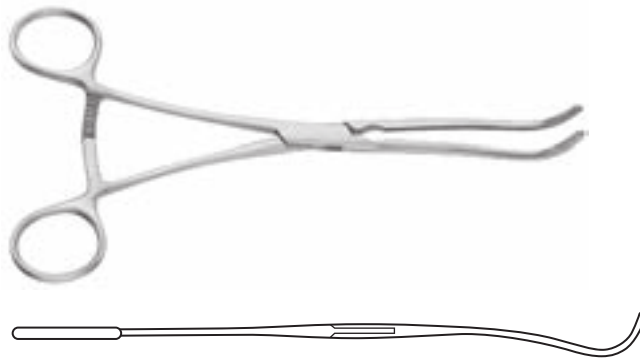

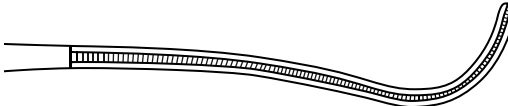
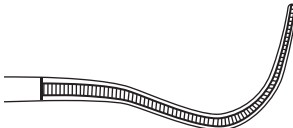
142-089-19	19,0cm; 7 4/8" 		
142-089-23	24,0cm; 9 4/8" 		

142

Peripheral-Gefäßklemmen
Peripheral Vascular Clamps

Art.Nr.	Beschreibung Description	Size	Spez.
142-100-16	DE BAKEY	16,0cm; 6 2/8"	<div data-bbox="1404 465 1492 548" style="border: 1px solid black; padding: 2px; text-align: center;"> ATRAUMA </div>

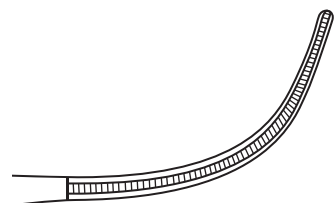
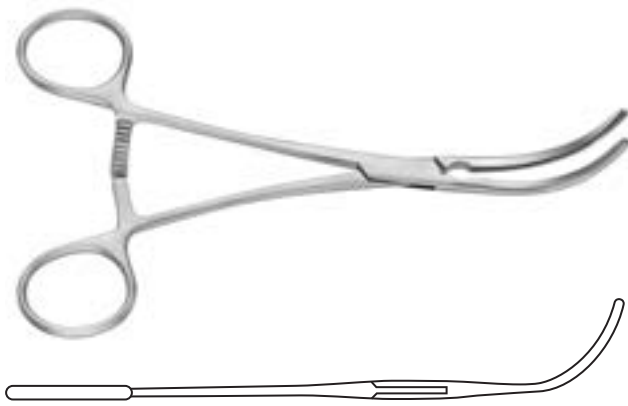

DE BAKEY

ATRAUMA

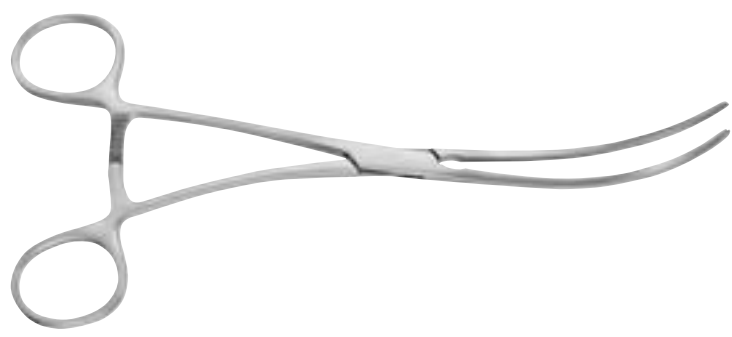

142-102-19

19,0cm; 7 4/8"

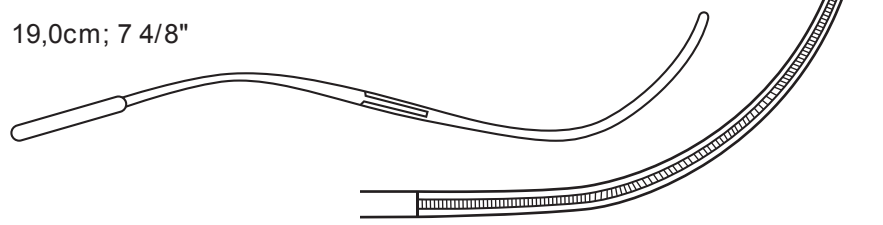

142-102-20

20,0cm; 7 7/8"

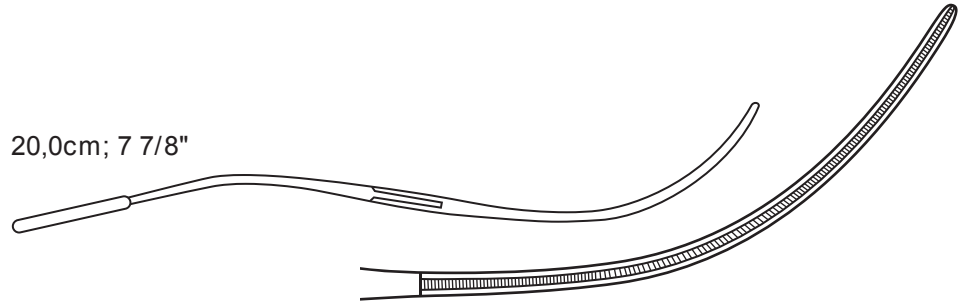

Peripheral-Gefäßklemmen
Peripheral Vascular Clamps





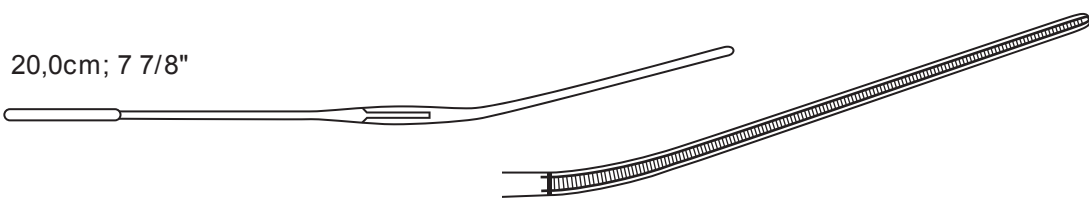
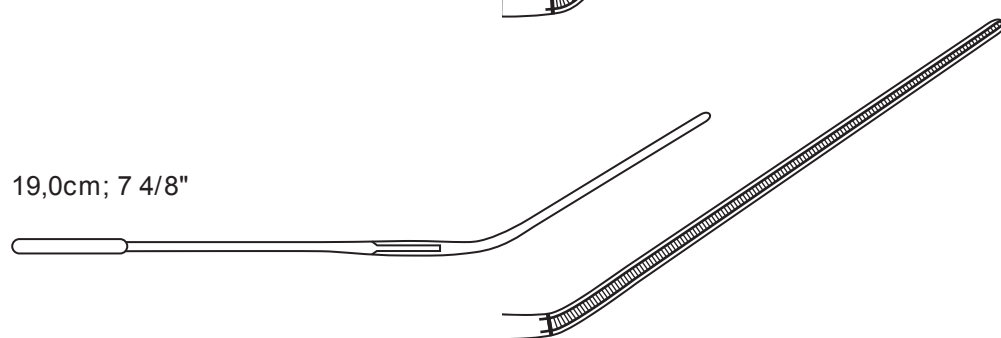
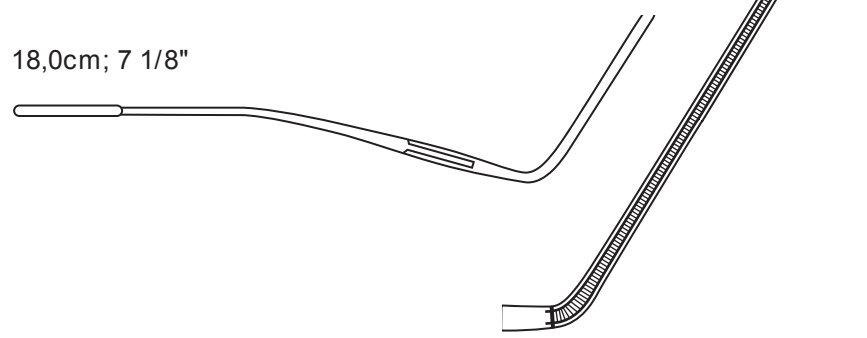



Art.Nr.	Beschreibung Description	Size	Spez.
LELAND-JONES			ATRAUMA
142-105-18	18,0cm; 7 1/8"		
142-105-19	19,0cm; 7 4/8"		
142-105-20	20,0cm; 7 7/8"		

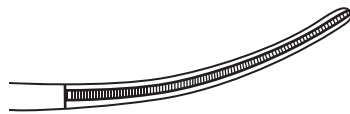

142

Mehrzweck-Gefäßklemmen
Multi purpose Vascular Clamps

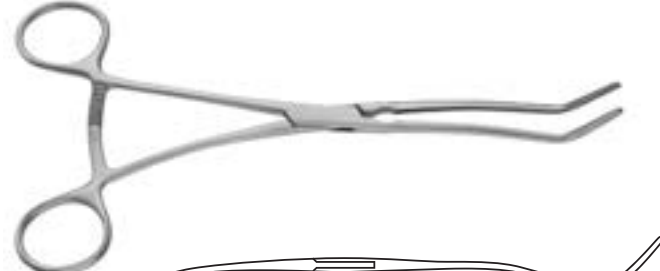
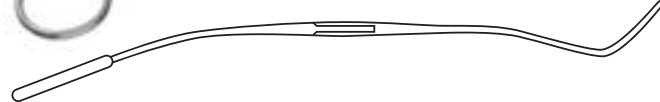
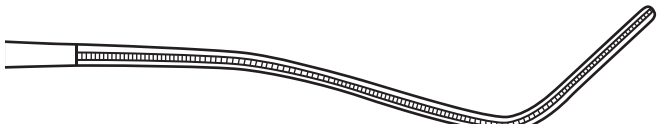
Art.Nr.	Beschreibung Description	Size	Spez.
	<p>BAINBRIDGE</p> 		<p>ATRAUMA</p>
142-110-15	<p>15,0cm; 5 7/8"</p> 		
142-110-18	<p>18,5cm; 7 2/8"</p> 		
			
142-111-15	<p>15,0cm; 5 7/8"</p> 		
142-111-18	<p>18,5cm; 7 2/8"</p> 		
142-115-20	<p>DE BAKEY</p>   	<p>20,0cm; 7 7/8"</p>	<p>ATRAUMA</p>

Aorta-Aneurysmaklemmen
Aortic Aneurysm Clamps



Art.Nr. Beschreibung | Description Size Spez.

DE BAKEY

ATRAUMA

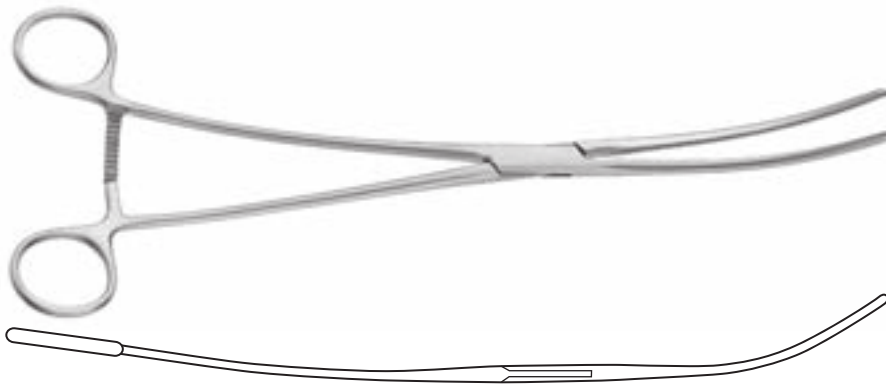

142-140-26
26,0cm; 10 2/8"

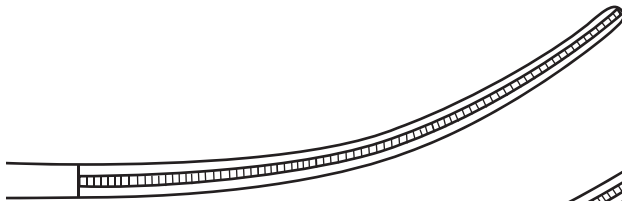

142-140-27
27,0cm; 10 5/8"

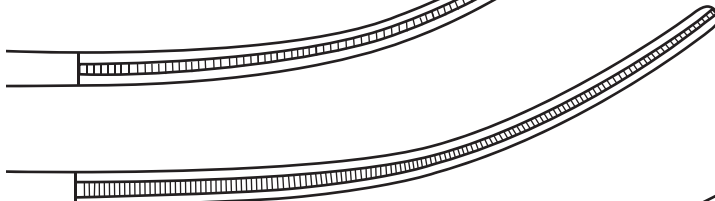

142-140-31
31,0cm; 12 2/8"

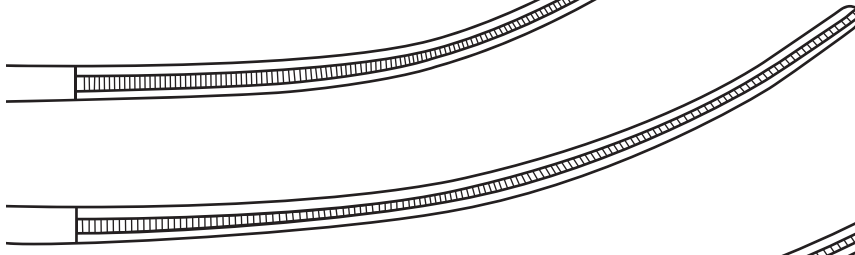

142-140-33
33,0cm; 13"

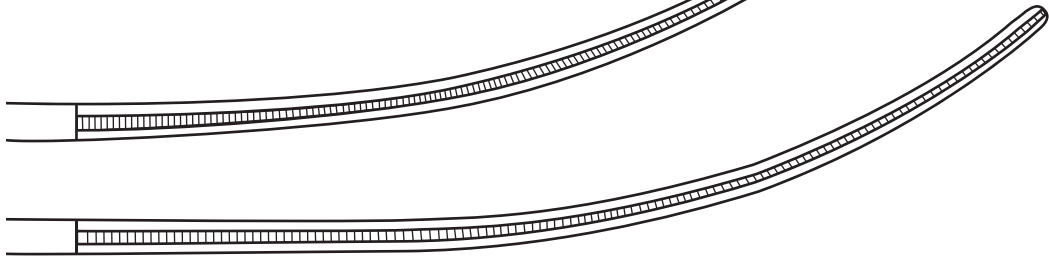

142-145-28

DE BAKEY

28,0cm; 11"

ATRAUMA

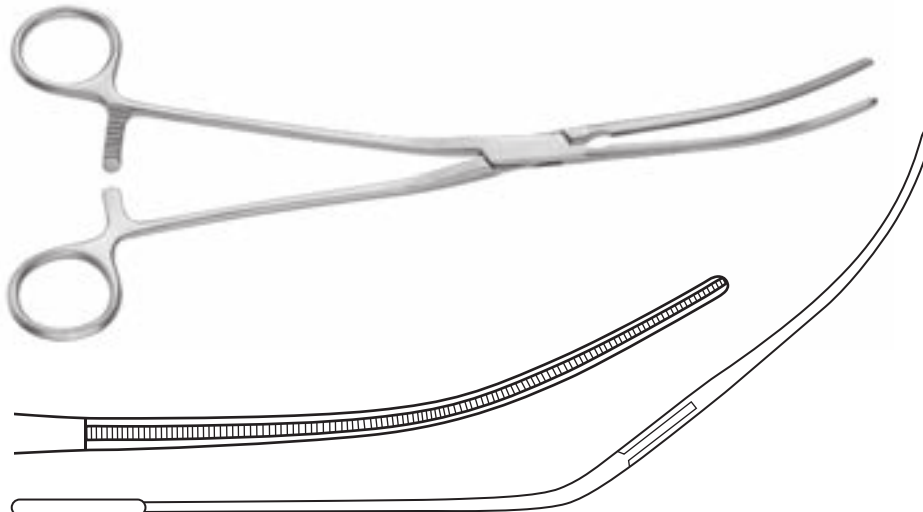

142

Aorta-Aneurysmaklemmen
Aortic Aneurysm Clamps

Art.Nr.	Beschreibung Description	Size	Spez.
142-147-30	DE BAKEY	30,0cm; 11 6/8"	ATRAUMA



Aorta-Ligaturklemmen
Aortic Ligature Forceps



Art.Nr.	Beschreibung Description	Size	Spez.
142-150-27	DE BAKEY	27,0cm; 10 5/8"	<div style="border: 1px solid black; padding: 2px; display: inline-block;"> ATRAUMA </div>

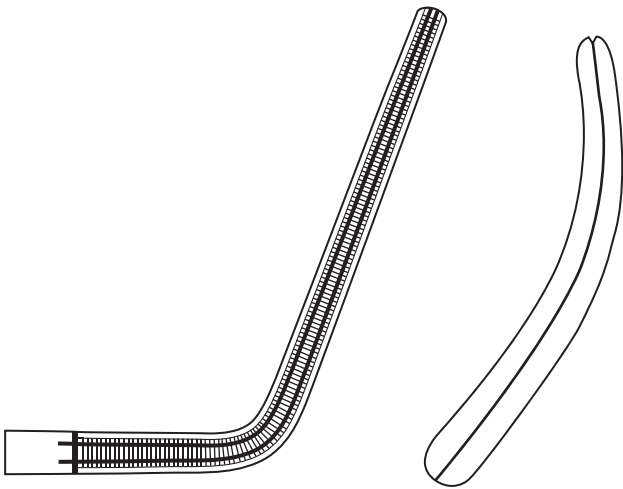
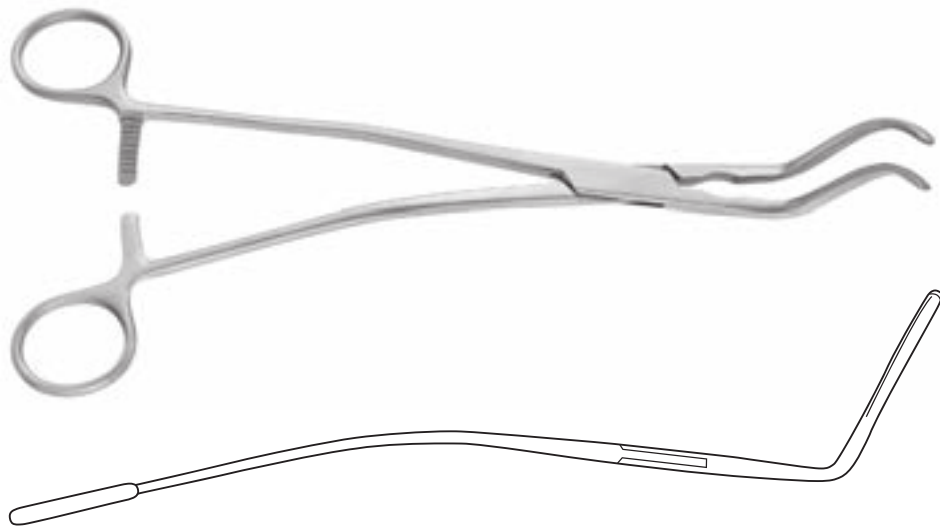

Ligaturklemmen, Aortaklemmen
 Ligature Forceps, Aortic Clamps

Art.Nr.	Beschreibung Description	Size	Spez.
142-155-24	DE BAKEY	24,5cm; 9 5/8"	<div data-bbox="1404 459 1508 548" style="border: 1px solid black; padding: 2px; display: inline-block;"> ATRAUMA </div>

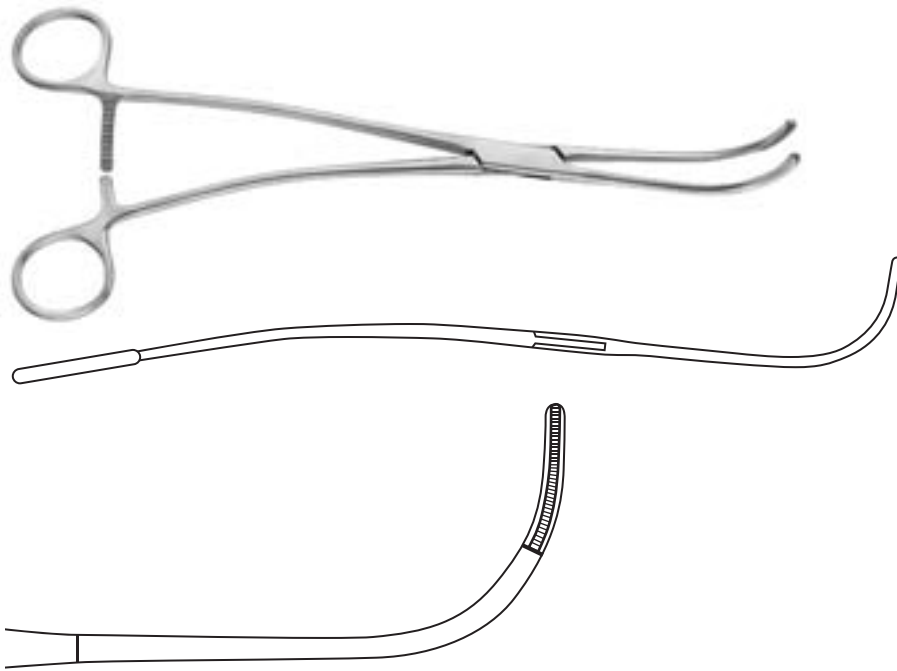

142-156-24	DE BAKEY	24,5cm; 9 5/8"	<div data-bbox="1404 1225 1508 1314" style="border: 1px solid black; padding: 2px; display: inline-block;"> ATRAUMA </div>
------------	----------	----------------	----------------------------------------------------------------------------------------------------------------------------------------------

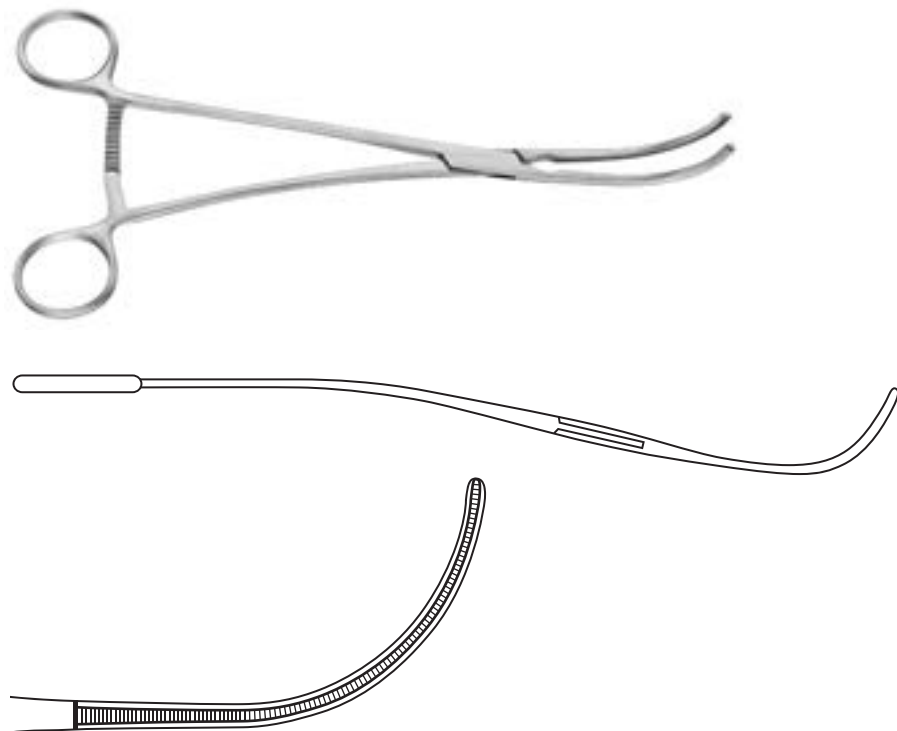

Ligaturklemmen, Aortaklemmen
Ligature Forceps, Aortic Clamps



Art.Nr.	Beschreibung Description	Size	Spez.
142-157-27	DE BAKEY	27,0cm; 10 5/8"	<input type="checkbox"/> ATRAUMA

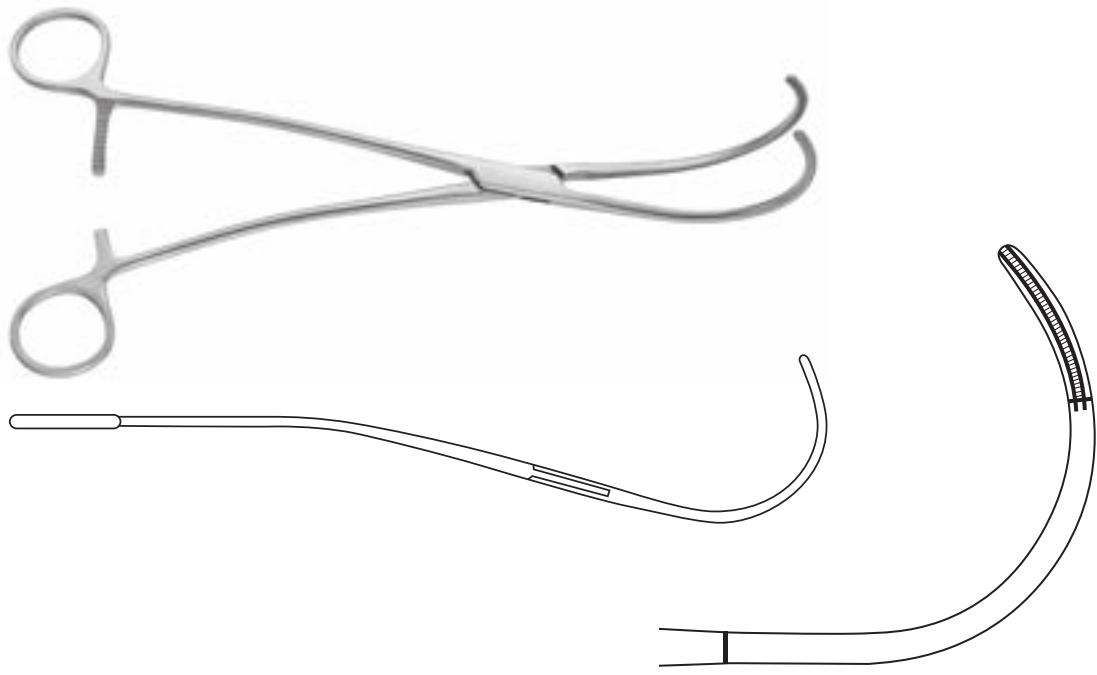

142-158-27	DE BAKEY	27,0cm; 10 5/8"	<input type="checkbox"/> ATRAUMA
------------	----------	-----------------	----------------------------------

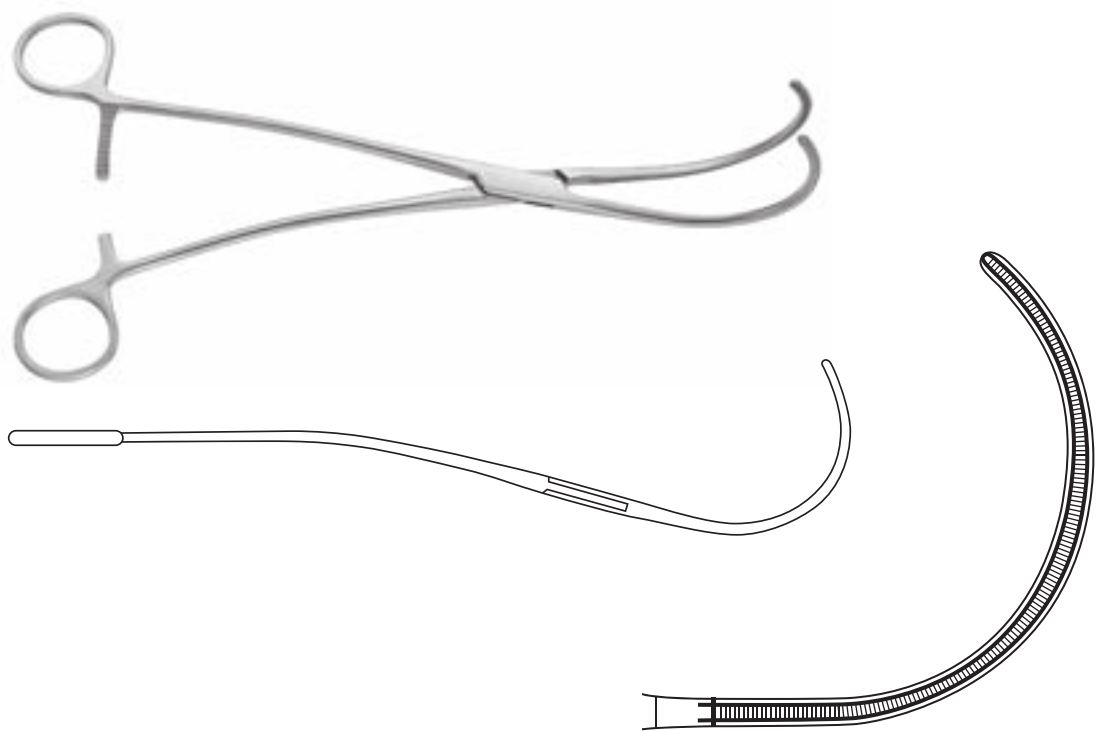

142

Aortaklemmen
Aortic Clamps

Art.Nr.	Beschreibung Description	Size	Spez.
142-201-01	WEBER	24,0cm; 9 4/8"	ATRAUMA

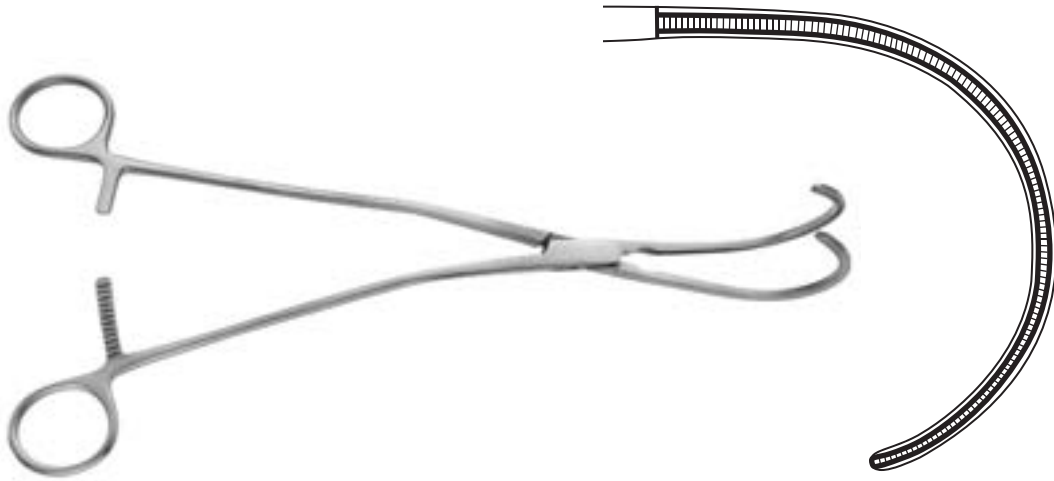

142-201-02	WEBER	24,0cm; 9 4/8"	ATRAUMA
------------	-------	----------------	---------

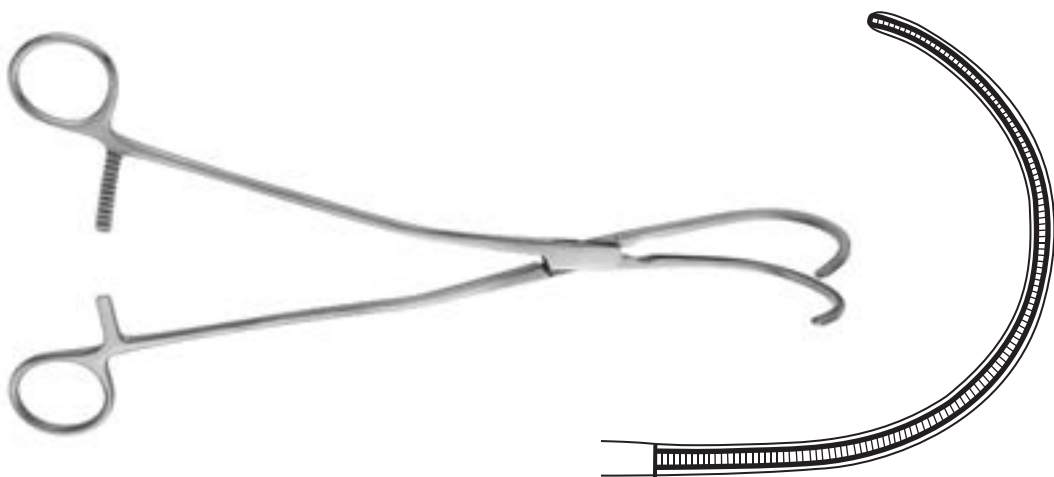

Tangentialklammern
Tangential Occlusion Clamps



Art.Nr.	Beschreibung Description	Size	Spez.
SATINSKY			<div style="border: 1px solid black; padding: 2px; display: inline-block;"> ATRAUMA </div>
142-210-20	22,0cm; 8 6/8"		
142-210-24	26,0cm; 10 2/8"		
142-210-25	26,5cm; 10 4/8"		
142-210-26	27,5cm; 10 6/8"		
142-210-27	28,5cm; 11 2/8"		

142

Art.Nr.	Beschreibung Description	Size	Spez.	
HARKEN			<div style="border: 1px solid black; padding: 2px; display: inline-block;"> ATRAUMA </div>	
142-220-01	24,5cm; 9 6/8"			
142-220-02	24,0cm; 9 4/8"			
142-220-03	23,0cm; 9"			
142-220-04	23,5cm; 9 2/8"			

Bronchusklemmen
Bronchus Clamps

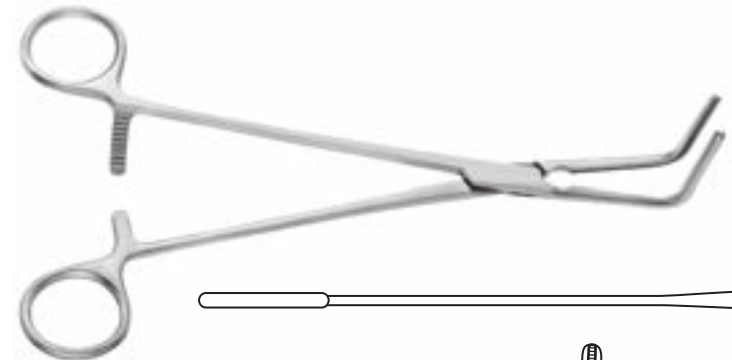
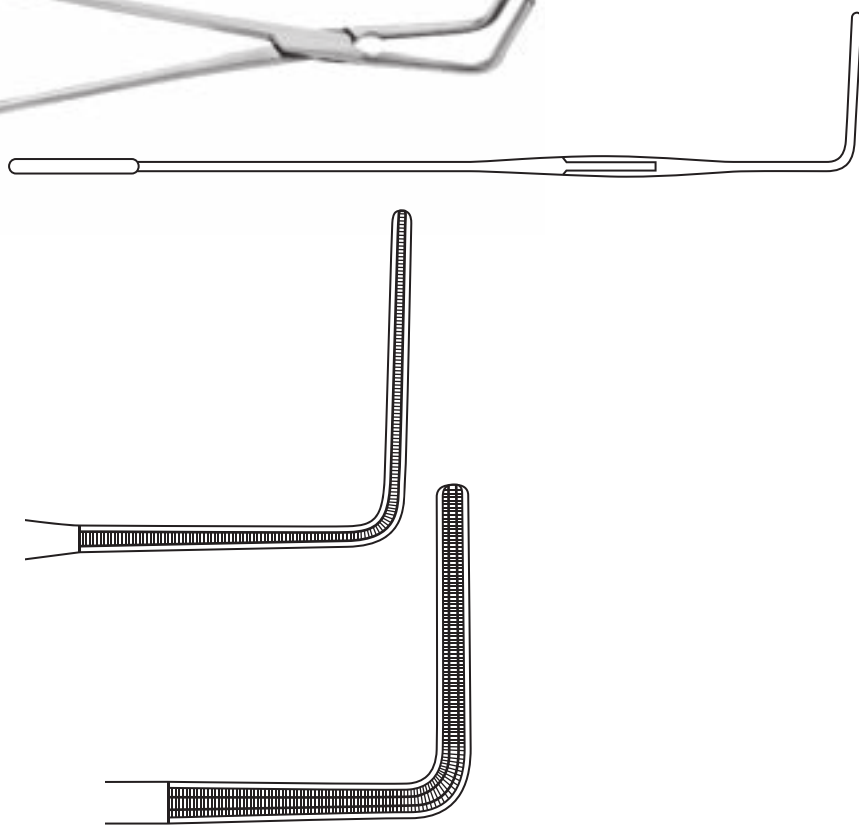
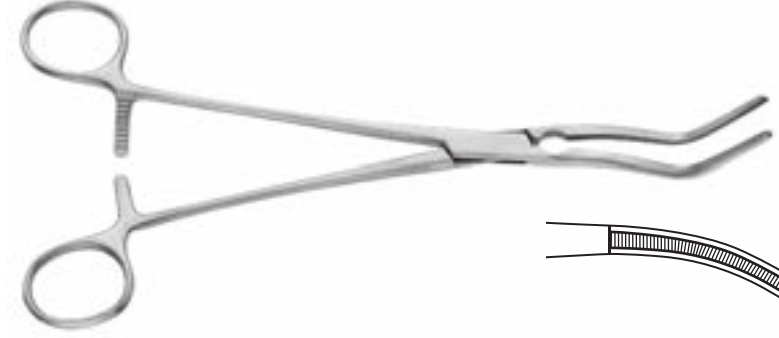
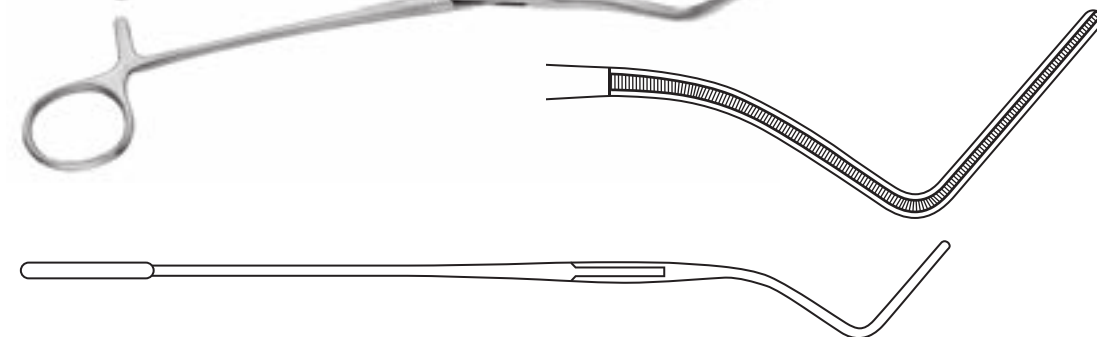

Art.Nr.	Beschreibung Description	Size	Spez.
	<p>LEES</p>  		<p>ATRAUMA</p>
142-225-23	23,0cm; 9,0"		
142-225-25	25,5cm; 10,0"		
142-227-25	LEES	26,0cm; 10 2/8"	ATRAUMA
	 		

142

Aorta-Anastomosenklemmen
Aorta-Anastomosis Clamps

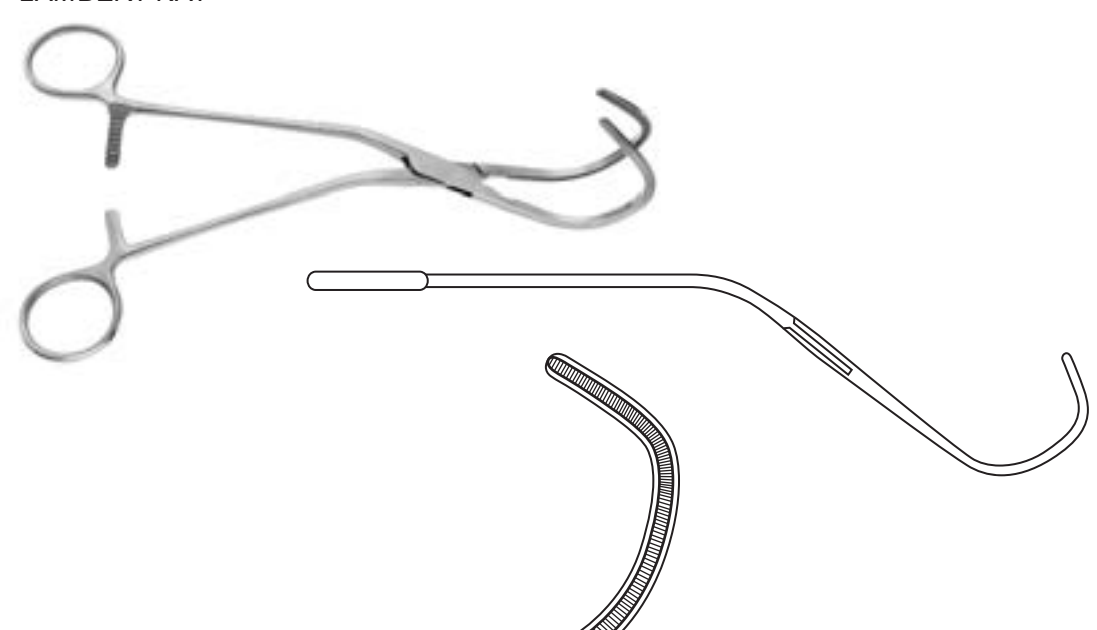
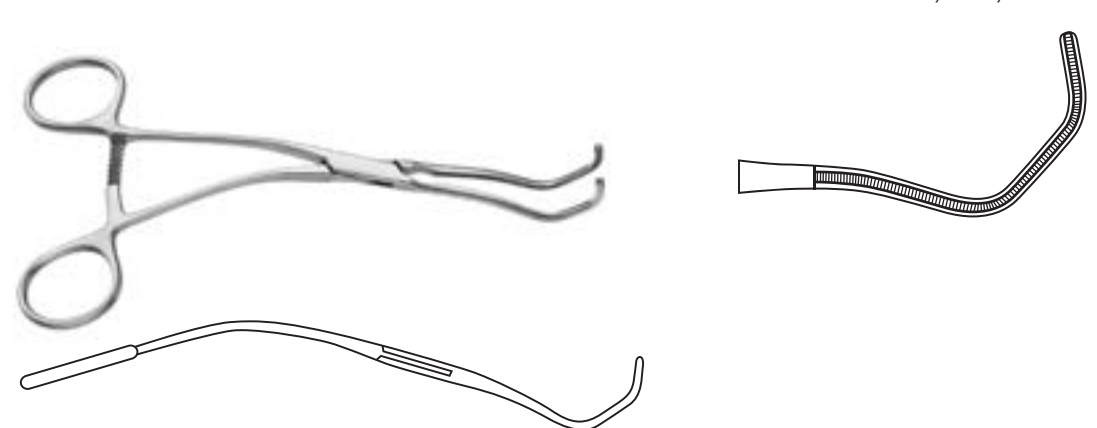
Art.Nr.	Beschreibung Description	Size	Spez.
	LAMBERT-KAY		<div data-bbox="1388 448 1511 560" style="border: 1px solid black; padding: 2px; text-align: center;"> ATRAUMA </div>
			
142-230-02	22,0cm; 8 6/8"		
142-230-01	20,5cm; 8 1/8"		
142-235-17	DE BAKEY	16,5cm; 6 4/8"	<div data-bbox="1388 1680 1511 1792" style="border: 1px solid black; padding: 2px; text-align: center;"> ATRAUMA </div>
			

Aortaklemmen
Aortic Clamps



Art.Nr.	Beschreibung Description	Size	Spez.
MORRIS-DE BAKEY			ATRAUMA
142-240-18	18,5cm; 7 2/8"		
142-240-20	20,0cm; 8"		
142-240-23	26,0cm; 10 2/8"		
142-240-25	27,5cm; 10 7/8"		

142

Aneurysmaklemmen
Aneurysm Clamps

Art.Nr. Beschreibung | Description Size Spez.

DE BAKEY-BAHNSON

ATRAUMA

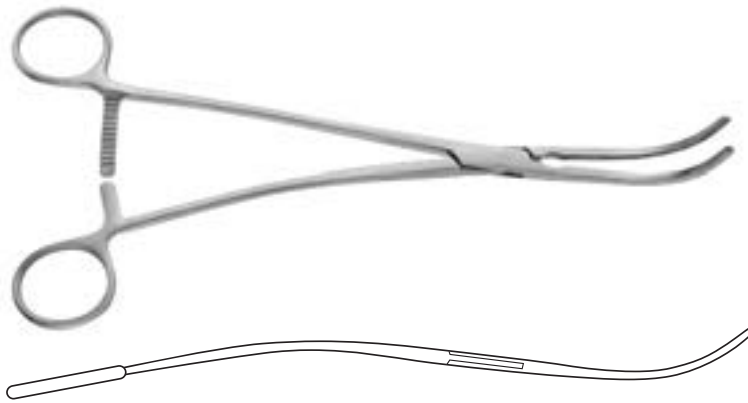

142-250-23 23,5cm; 9 2/8"

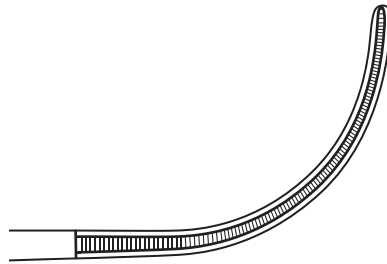

142-250-24 24,5cm; 9 5/8"

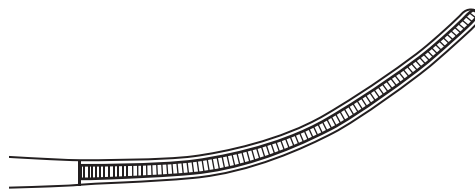

142-250-25 25,5cm; 10"

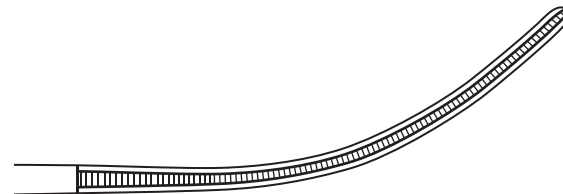

Mehrzweck-Gefäßklemmen
Multi purpose Vascular Clamps



Art.Nr.	Beschreibung Description	Size	Spez.
---------	----------------------------	------	-------

POTTS

ATRAUMA



142-280-21

21,5cm; 8 4/8"



142-280-23

23,5cm; 9 2/8"



142-280-27

27,0cm; 10 5/8"



142-280-31

31,5cm; 12 3/8"





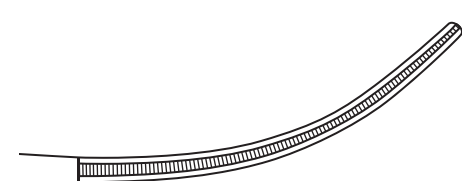
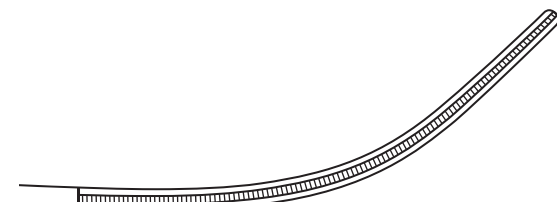
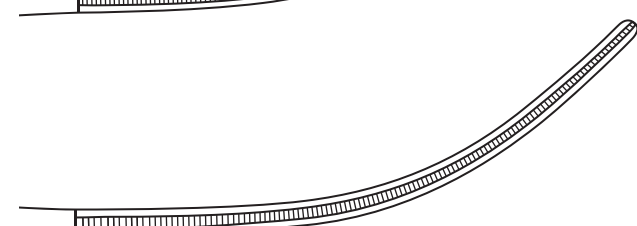
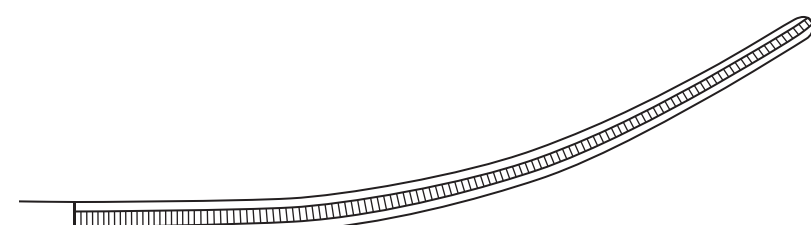

142

Mehrzweck-Gefäßklemmen
Multi purpose Vascular Clamps

Art.Nr.	Beschreibung Description	Size	Spez.
	POTTS		<div style="border: 1px solid black; padding: 2px; display: inline-block;"> ATRAUMA </div>
			
142-281-21	21,0cm; 8 2/8"		
142-281-23	23,0cm; 9,0"		
142-281-27	26,0cm; 10 2/8"		
142-281-31	31,0cm; 12 2/8"		

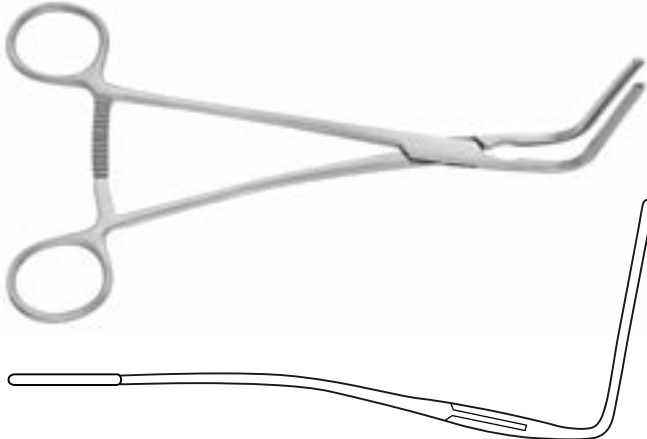
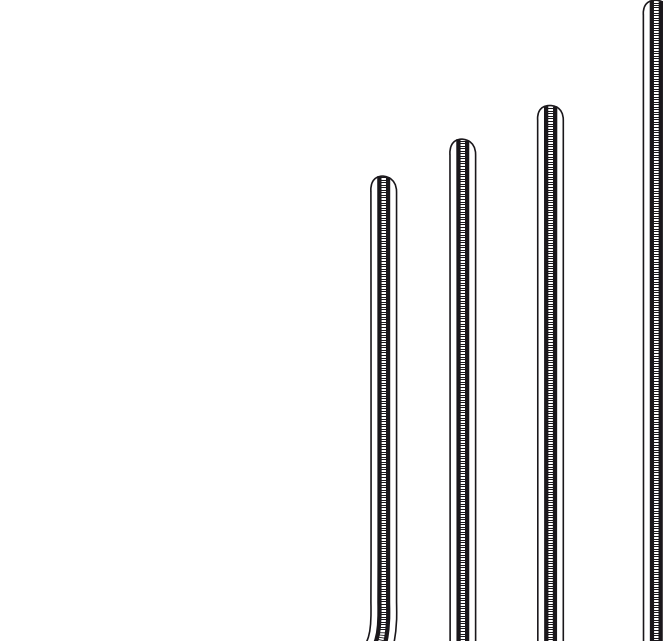
Mehrzweck-Gefäßklemmen
Multi purpose Vascular Clamps



Art.Nr.	Beschreibung Description	Size	Spez.
	DE BAKKEY		<div data-bbox="1401 465 1492 555" style="border: 1px solid black; padding: 2px; display: inline-block;"> ATRAUMA </div>
			
			
142-282-18	19,0cm; 7 4/8"		
142-282-19	20,0cm; 7 7/8"		
142-282-23	23,0cm; 9,0"		
142-282-27	23,0cm; 10 6/8"		

142

Mehrzweck-Gefäßklemmen
Multi purpose Vascular Clamps

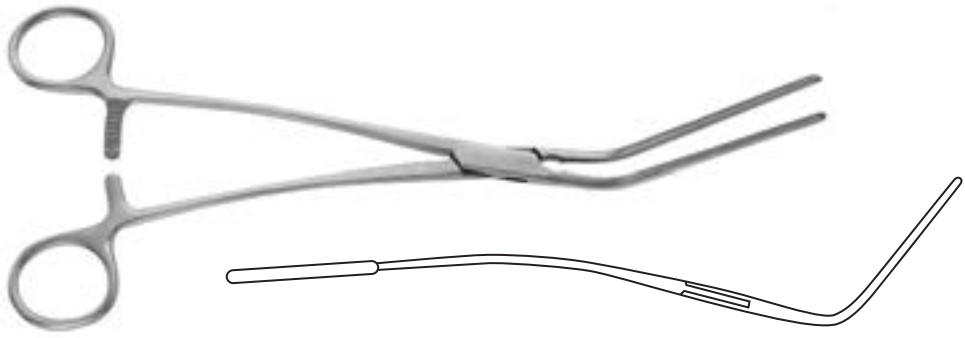
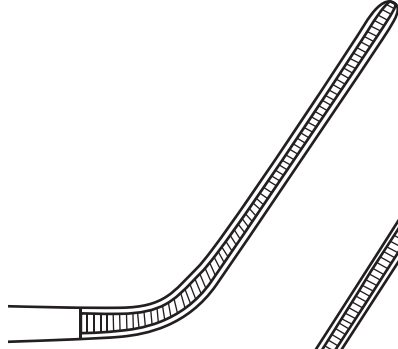
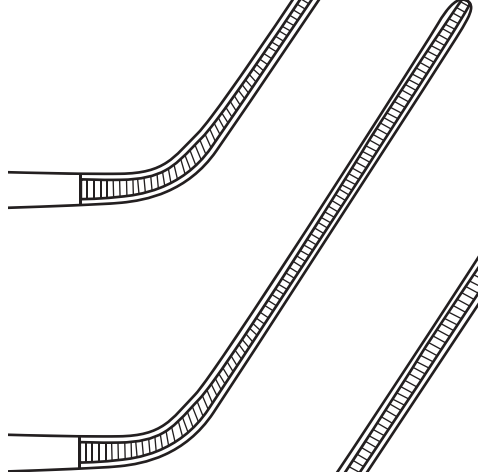
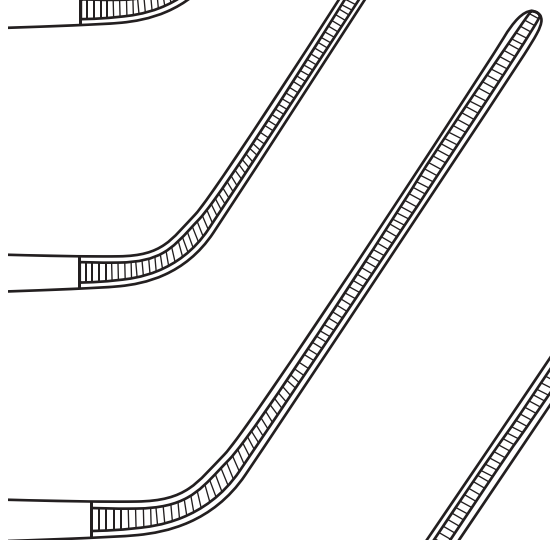
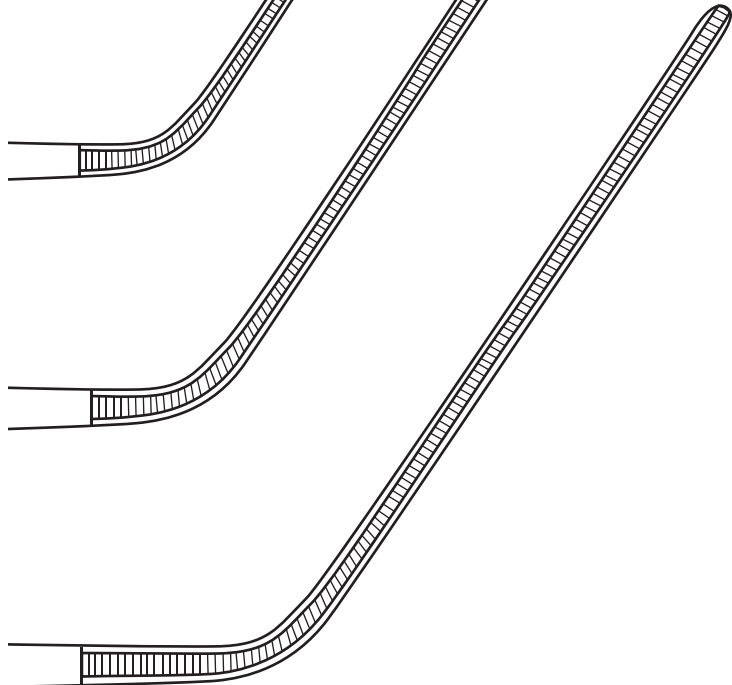
Art.Nr.	Beschreibung Description	Size	Spez.
DE BAKEY			<div style="border: 1px solid black; padding: 2px; display: inline-block;"> ATRAUMA </div>
142-283-20		21,0cm; 8 2/8"	
142-283-21		22,0cm; 8 6/8"	
142-283-25		26,0cm; 10 2/8"	
142-283-29		31,5cm; 12 3/8"	

Arterienklemmen
Haemostatic Forceps



Art.Nr. Beschreibung | Description Size Spez.

DE BAKEY-MOSQUITO

12,5cm; 4 7/8"

ATRAUMA



142-310-12



142-311-12



DE BAKEY-PEAN

ATRAUMA



142-314-14

14,5cm; 5 6/8"



142-314-16

16,5cm; 6 4/8"



142-314-18

18,5cm; 7 2/8"



142-314-20

20,5cm; 8 1/8"

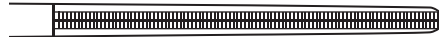

142

Art.Nr.	Beschreibung Description	Size	Spez.
---------	----------------------------	------	-------

DE BAKEY-PEAN

ATRAUMA



142-315-14

14,5cm; 5 6/8"



142-315-16

16,5cm; 6 4/8"



142-315-18

18,5cm; 7 2/8"

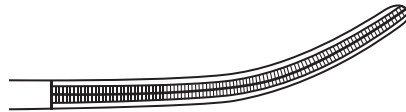

142-315-20

20,0cm; 7 7/8"



Mehrzweck-Gefäßklemmen
Multi purpose Vascular Clamps



Art.Nr.	Beschreibung Description	Size	Spez.
---------	----------------------------	------	-------

142-320-17	DE BAKEY	17,5cm; 6 7/8"	ATRAUMA
------------	----------	----------------	---------



	DE BAKEY		ATRAUMA
--	----------	--	---------

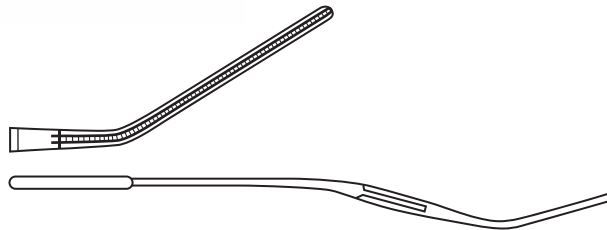

142-327-16	16,5cm; 6,4/8"		
------------	----------------	--	--

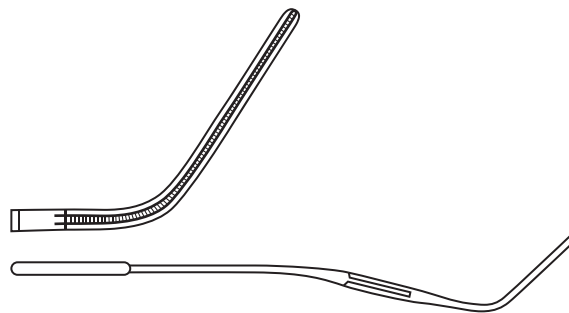

142-323-15	16,0cm; 6 2/8"		
------------	----------------	--	--

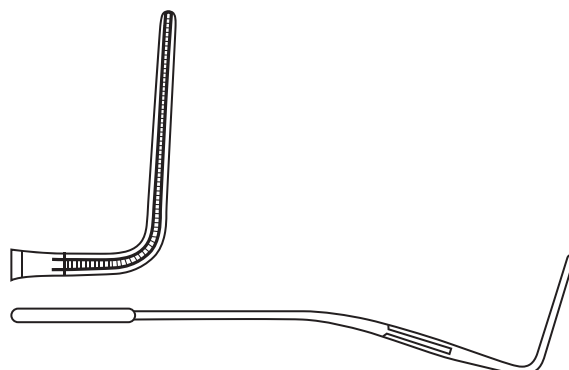

142-325-15	15,0 cm, 5 7/8"		
------------	-----------------	--	--

142

Mehrzweck-Gefäßklemmen
Multi purpose Vascular Clamps

Art.Nr.	Beschreibung Description	Size	Spez.
142-329-17	DE BAKEY	16,5cm; 6 4/8"	ATRAUMA



Mehrzweck-Gefäßklemmen
Multi purpose Vascular Clamps



Art.Nr.	Beschreibung Description	Size	Spez.
142-340-17	GLOVER	17,0cm; 6 6/8"	<div data-bbox="1396 465 1492 555" style="border: 1px solid black; padding: 2px; text-align: center;"> ATRAUMA </div>

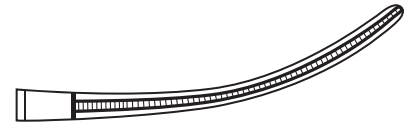

142-341-17	GLOVER	17,5cm; 6 7/8"	<div data-bbox="1396 1193 1492 1294" style="border: 1px solid black; padding: 2px; text-align: center;"> ATRAUMA </div>
------------	--------	----------------	------------------------------------------------------------------------------------------------------------------------------------------------------------



Anastomosenklemmen
Anastomosis Clamps

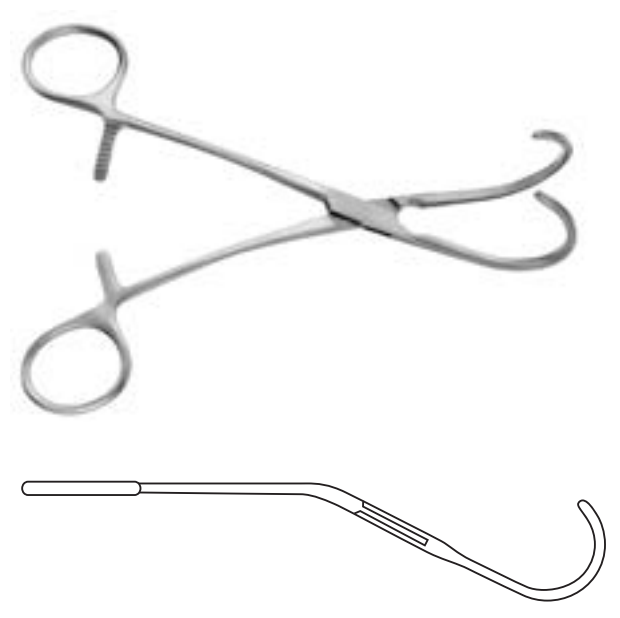
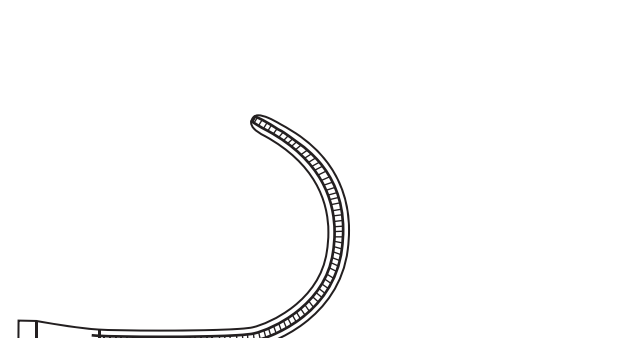
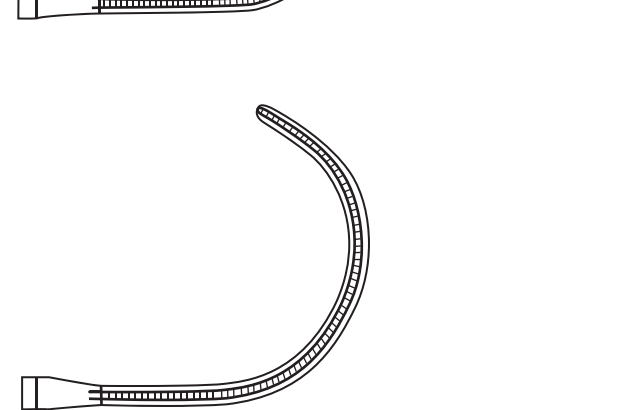





Art.Nr.	Beschreibung Description	Size	Spez.
	DE BAKEY	16,5cm; 6 4/8"	<div data-bbox="1388 448 1511 560" style="border: 1px solid black; padding: 2px; display: inline-block;"> ATRAUMA </div>
			
142-345-16			
142-345-17			

Anastomosenklemmen
Anastomosis Clamps

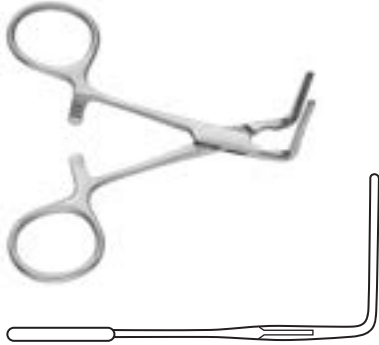

Art.Nr.	Beschreibung Description	Size	Spez.
DERRA			
ATRAUMA			
142-380-16	Fig. 1 16,5cm; 6 4/8"		
142-380-17	Fig. 2 17,0cm; 6 6/6"		
142-380-18	Fig. 3 17,5cm; 6 5/8"		
142-385-17	DE BAKEY-BECK	17,0cm; 6 6/8"	ATRAUMA

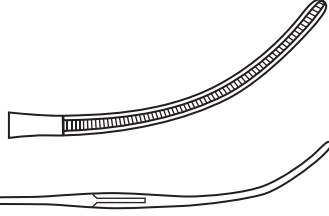
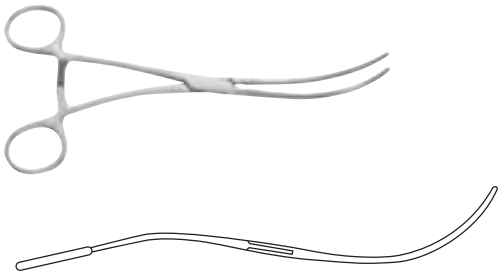
142

Art.Nr.	Beschreibung Description	Size	Spez.
142-501-10	DE BAKEY 	10,0cm; 3 7/8"	
	DE BAKEY 	13,0cm; 5 1/8"	
142-510-11		142-511-12	
142-513-12	DE BAKEY 	12,5cm; 4 7/8"	

Kinder-Gefäßklemmen
Pediatric Vascular Clamps



Art.Nr.	Beschreibung Description	Size	Spez.
---------	----------------------------	------	-------



142-515-13	DE BAKEY	12,5cm; 4 7/8"	<div style="border: 1px solid black; padding: 2px; color: green;">ATRAUMA</div>
------------	----------	----------------	---------------------------------------------------------------------------------





COOLEY	14,5cm; 5,6/8"	<div style="border: 1px solid black; padding: 2px; color: green;">ATRAUMA</div>
--------	----------------	---------------------------------------------------------------------------------



142-520-14		142-521-14	
------------	-------------------------------------------------------------------------------------	------------	--------------------------------------------------------------------------------------

142-523-14	COOLEY	14,5cm; 5 6/8"	<div style="border: 1px solid black; padding: 2px; color: green;">ATRAUMA</div>
------------	--------	----------------	---------------------------------------------------------------------------------



142

Kinder-Gefäßklemmen
Pediatric Vascular Clamps

Art.Nr.	Beschreibung Description	Size	Spez.
142-555-14	COOLEY	14,0cm; 5 4/8"	ATRAUMA

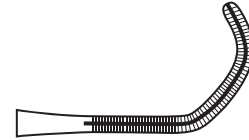

142-557-14	COOLEY	14,5cm; 5 6/8"	ATRAUMA
------------	--------	----------------	---------



Anastomosenklemmen, Mehrzweck-Gefäßklemmen
 Anastomosis Clamps, Multi purpose Vascular Clamps



Art.Nr.	Beschreibung Description	Size	Spez.
142-601-21	COOLEY Iliacaklemme Iliac Clamp	22,0cm; 8 5/8"	ATRAUMA

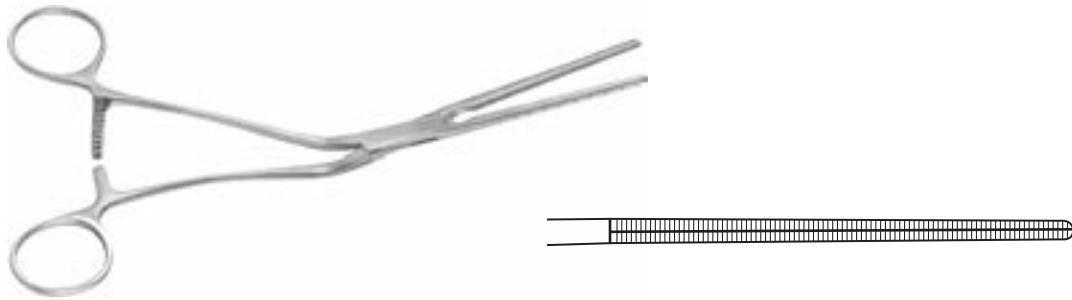

142-603-17	COOLEY	17,0cm; 6 6/8"	ATRAUMA
------------	--------	----------------	---------

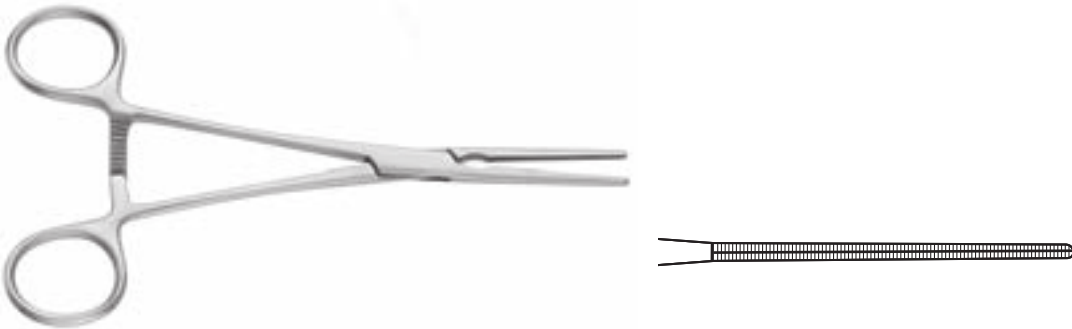

142-605-20	COOLEY Carotisklemme Carotid Clamp	20,0cm; 7 7/8"	ATRAUMA
------------	---------------------------------------	----------------	---------

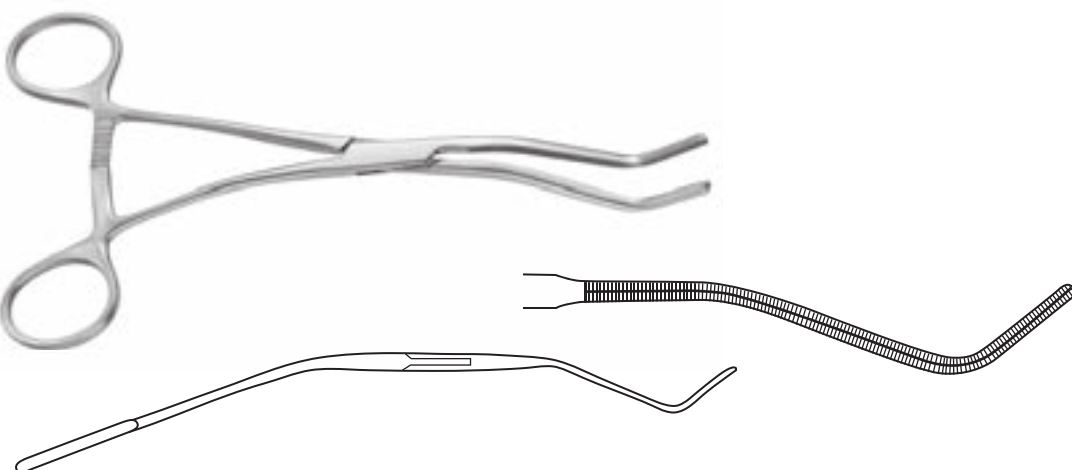

Anastomosenklemmen, Mehrzweck-Gefäßklemmen
 Anastomosis Clamps, Multi purpose Vascular Clamps

Art.Nr.	Beschreibung Description	Size	Spez.
142-607-17	COOLEY	17,0cm; 6 6/8"	<div data-bbox="1412 488 1484 555" style="border: 1px solid green; padding: 2px; text-align: center;"> ATRAUMA </div>
<div data-bbox="268 533 1348 940"> </div>			
142-609-16	COOLEY	16,0cm; 6 2/8"	<div data-bbox="1412 1041 1484 1108" style="border: 1px solid green; padding: 2px; text-align: center;"> ATRAUMA </div>
<div data-bbox="268 1086 1348 1467"> </div>			
142-610-15	COOLEY	14,5cm; 5 6/8"	<div data-bbox="1412 1657 1484 1724" style="border: 1px solid green; padding: 2px; text-align: center;"> ATRAUMA </div>
<div data-bbox="268 1691 1348 2024"> </div>			

Anastomosenklemmen, Mehrzweck-Gefäßklemmen
 Anastomosis Clamps, Multi purpose Vascular Clamps



Art.Nr.	Beschreibung Description	Size	Spez.
142-611-16	COOLEY	16,0cm; 6 2/8"	<input type="checkbox"/> ATRAUMA
142-612-17	COOLEY	16,5cm; 6 4/8"	<input type="checkbox"/> ATRAUMA
142-613-17	COOLEY	17,0cm; 6 6/8"	<input type="checkbox"/> ATRAUMA

Anastomosenklemmen, Mehrzweck-Gefäßklemmen
 Anastomosis Clamps, Multi purpose Vascular Clamps

Art.Nr.	Beschreibung Description	Size	Spez.
---------	----------------------------	------	-------

142-614-17	COOLEY	17,0cm; 6 6/8"	<div style="border: 1px solid green; padding: 2px; display: inline-block;"> ATRAUMA </div>
------------	--------	----------------	--------------------------------------------------------------------------------------------------------------

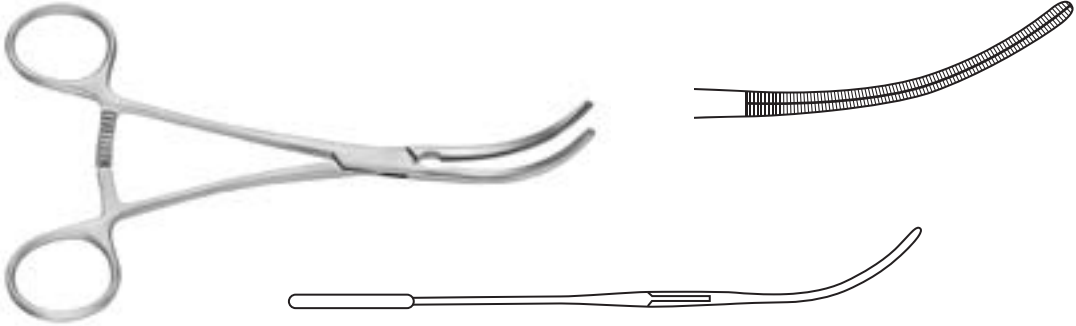

142-615-17	COOLEY	17,5cm; 6 7/8"	<div style="border: 1px solid green; padding: 2px; display: inline-block;"> ATRAUMA </div>
------------	--------	----------------	--------------------------------------------------------------------------------------------------------------

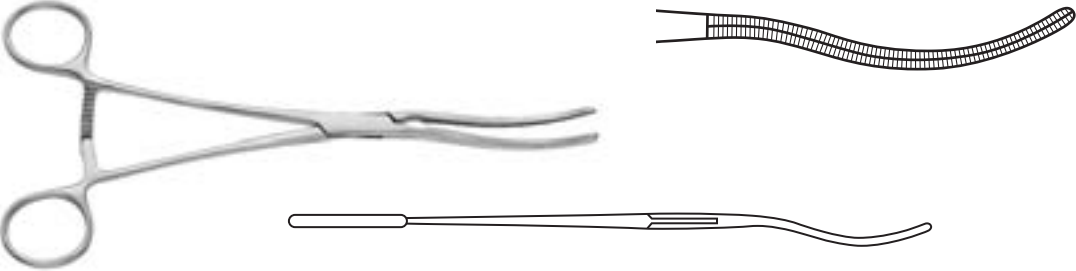

	COOLEY	16,5cm; 6 4/8"	<div style="border: 1px solid green; padding: 2px; display: inline-block;"> ATRAUMA </div>
--	--------	----------------	--------------------------------------------------------------------------------------------------------------

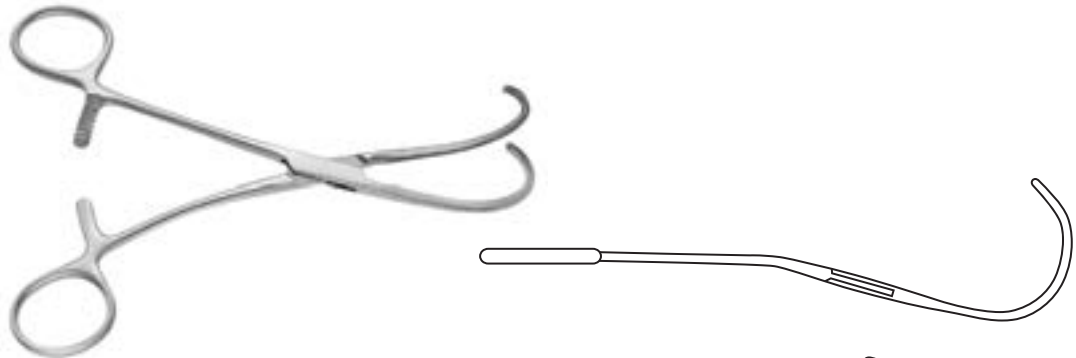

142-617-16			
	142-617-17		

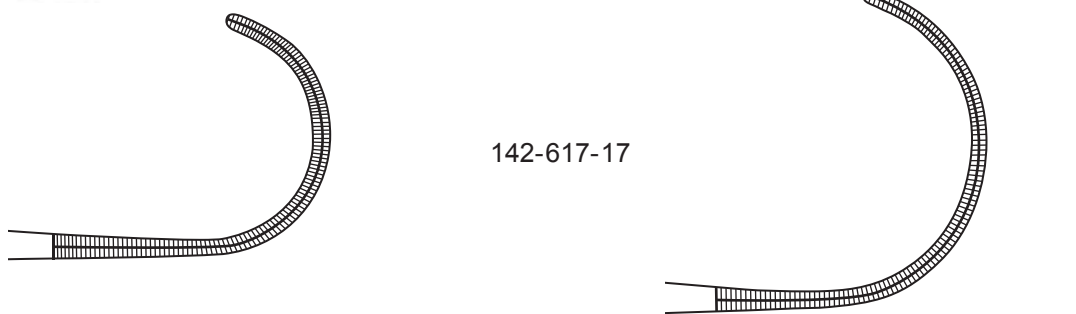

Anastomosenklemmen
Anastomosis Clamps



Art.Nr.	Beschreibung Description	Size	Spez.
COOLEY-DERRA			ATRAUMA
142-620-16	16,5cm; 6 4/8"		
142-620-17	17,0cm; 6 6/8"		
142-620-18	17,5cm; 6 7/8"		

142

Kinder-Aortaklemmen, Kinder-Gefäßklemmen
 Pediatric Aortic Clamps, Pediatric Vascular Clamps

Art.Nr.	Beschreibung Description	Size	Spez.
142-625-17	COOLEY-BECK	17,0cm; 6 6/8"	<div data-bbox="1396 470 1492 560" style="border: 1px solid black; padding: 2px; text-align: center;"> ATRAUMA </div>

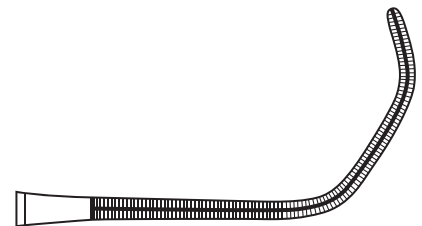
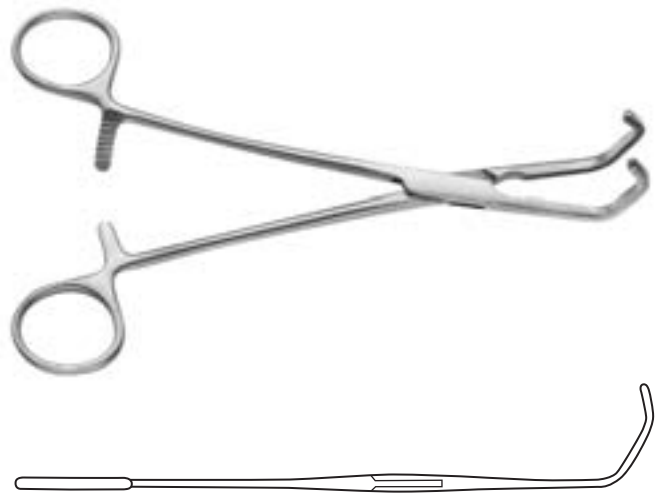

142-630-15	Subramanian-Miniature	16,5cm; 6 4/8"	<div data-bbox="1396 1176 1492 1265" style="border: 1px solid black; padding: 2px; text-align: center;"> ATRAUMA </div>
------------	-----------------------	----------------	-------------------------------------------------------------------------------------------------------------------------------------------

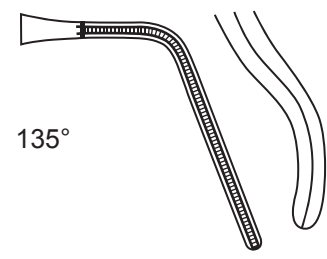
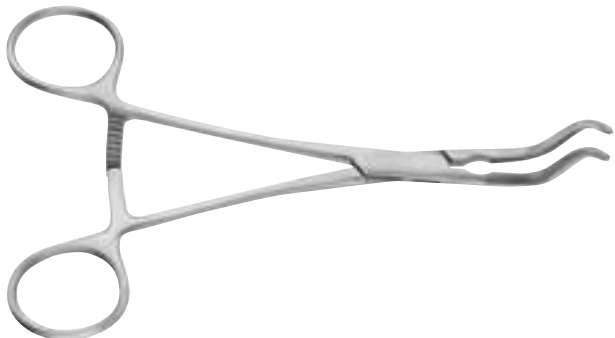

Kinder-Aortaklemmen, Kinder-Gefäßklemmen
 Pediatric Aortic Clamps, Pediatric Vascular Clamps



Art.Nr.	Beschreibung Description	Size	Spez.
---------	----------------------------	------	-------

SUBRAMANIAN

16,0cm; 6 2/8"

ATRAUMA



142-631-01

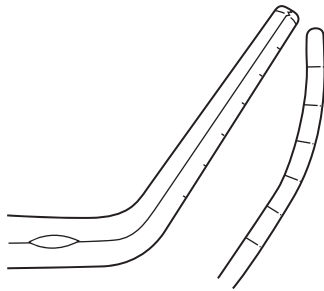

142-631-02

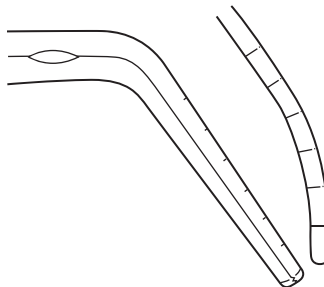

142

Kinder-Gefäßklemmen
 Pediatric Vascular Clamps

Art.Nr. Beschreibung | Description Size Spez.

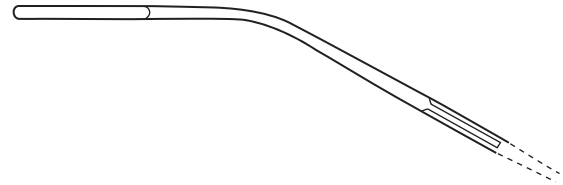

ATRAUMA

142-711-01
 14,0cm; 5 4/8"

Fig. 1



142-711-06
 13,0cm; 5"

Fig. 6

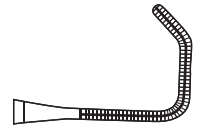

142-711-02
 14,0cm; 5 4/8"

Fig. 2



142-711-07
 13,0cm; 5"

Fig. 7

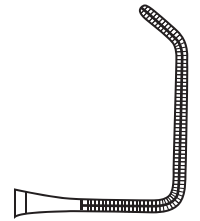

142-711-03
 14,0cm; 5 4/8"

Fig. 3

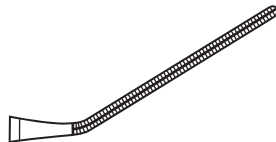

142-711-08
 14,0cm; 5 4/8"

Fig. 8

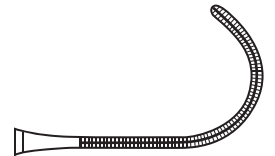

142-711-04
 14,0cm; 5 4/8"

Fig. 4

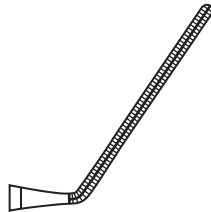

142-711-09
 13,0cm; 5"

Fig. 9

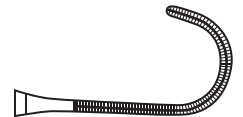

142-711-05
 14,0cm; 5 4/8"

Fig. 5



Kinder-Gefäßklemmen
Pediatric Vascular Clamps



Art.Nr. Beschreibung | Description Size Spez.

ATRAUMA

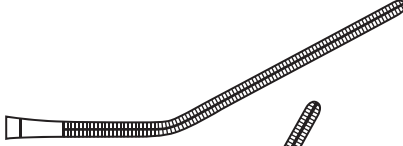

142-720-16 16,5cm; 6 4/8" 

142-721-16 16,5cm; 6 4/8" 

142-723-15 15,5cm; 6" 

ATRAUMA



142-725-15 15,5cm; 6" 

142-727-15 16,0cm; 6 2/8" 

142

Neonatal-Gefäßklemmen
Neonatal Vascular Clamps

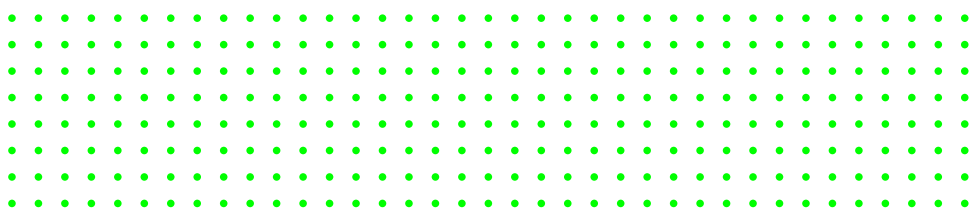

Art.Nr. Beschreibung | Description Size Spez.

CASTAÑEDA

ATRAUMA



142-735-01

12,5cm; 5"

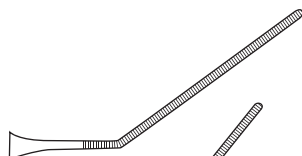

142-735-03

11,0cm; 4 2/8"



142-735-02

12,0cm; 4 6/8"

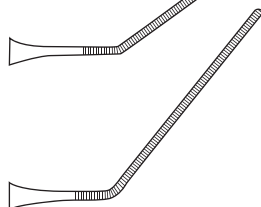

CASTAÑEDA

12,0cm; 4 6/8"

ATRAUMA

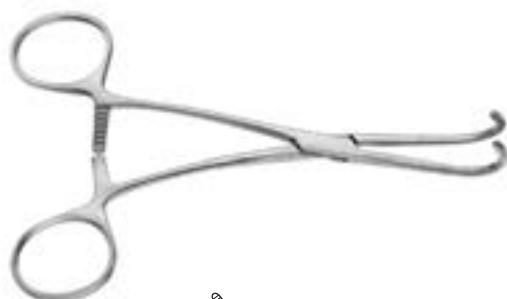

142-735-04

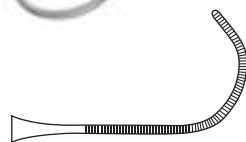

142-735-05

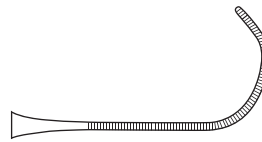

142-735-06

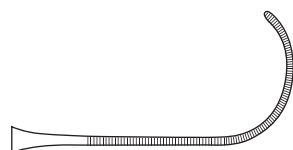

142-735-07

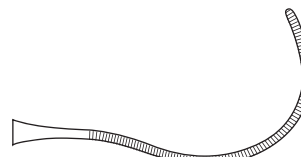

Weitere Artikel
further items



Art.Nr.	Beschreibung Description	Size	Spez.
Other items available but not illustrated			
142-252-24	WYLIE Aortic Clamp shanks angled; atraumatic	24,0cm; 9,4"	
142-252-27	shanks angled; atraumatic	27,0cm; 10,6"	

Alphabetisches Verzeichnis

A		
Anastomosenklemme, COOLEY	142.42	
Anastomosenklemme, COOLEY-DERRA	142.46	
Anastomosenklemme, DE BAKEY	142.37	
Anastomosenklemme, DE BAKEY-BECK	142.38	
Anastomosenklemme, DERRA	142.38	
Aneurysmaklemme, DE BAKEY-BAHNSON	142.27	
Aorta-Anastomosenklemme, DE BAKEY	142.25	
Aorta-Anastomosenklemme, LAMBERT-KAY	142.25	
Aorta-Aneurysmaklemme, DE BAKEY	142.16, 142.17	
Aortaklemme, DE BAKEY	142.19, 142.20	
Aortaklemme, DIETRICH	142.3	
Aortaklemme, Kinder-, COOLEY-BECK	142.47	
Aortaklemme, MORRIS-DE BAKEY	142.26	
Aortaklemme, OCHSNER	142.3	
Aortaklemme, WEBER	142.21	
Aorta-Ligaturklemme, DE BAKEY	142.18	
Arterienklemme, DE BAKEY-MOSQUITO	142.2, 142.32	
Arterienklemme, DE BAKEY-PEAN	142.32, 142.33	
Arterienklemme, DE BAKEY-RANKIN	142.2	
Aurikelklemme, HARKEN	142.23	
		DE BAKEY, Aorta-Aneurysmaklemme
		142.16, 142.17
		DE BAKEY, Aortaklemme
		142.19, 142.20
		DE BAKEY, Aorta-Ligaturklemme
		142.18
		DE BAKEY, Gefäßdilator
		141.5
		DE BAKEY, Kinder-Gefäßklemme
		142.39, 142.40
		DE BAKEY, Ligaturklemme
		142.19, 142.20
		DE BAKEY, Mehrzweck-Gefäßklemme ...
		142.15, 142.30- 142.35
		DE BAKEY, Peripheral-Gefäßklemme
		142.13
		DE BAKEY, Präparier- und Ligaturklemme
		142.12
		DE BAKEY, Rippensperrerr
		140.12, 140.13
		DE BAKEY-BAHNSON, Aneurysmaklemme
		142.27
		DE BAKEY-BECK, Anastomosenklemme
		142.38
		DE BAKEY-MOSQUITO, Arterienklemme
		142.2, 142.32
		DE BAKEY-PEAN, Arterienklemme
		142.32, 142.33
		DE BAKEY-RANKIN, Arterienklemme
		142.2
		DERRA, Anastomosenklemme
		142.38
		DIETRICH, Aortaklemme
		142.3
		Dilatator, Gefäß-, COOLEY
		141.6
		Dilatator, Gefäß-, DE BAKEY
		141.5
B		F
BAILEY, Rippenkontraktor	140.16	Fadenfänger
BAILEY-BABY, Rippenkontraktor	140.15	141.4
BAILEY-GIBBON, Rippenkontraktor	140.16	FINOCHIETTO ALUMINIUM, Rippensperrerr
BAINBRIDGE, Mehrzweck-Gefäßklemme	142.15	140.6
BETHUNE, Rippenschere	140.3	FINOCHIETTO BABY ALUMINIUM, Rippensperrerr
Bronchusklemme, LEES	142.24	140.6
Bronchusklemme, PRICE-THOMAS	141.2	FINOCHIETTO BABY, Rippensperrerr
Bronchusklemme, SEMB	141.2	140.11
BRUNNER, Rippenschere	140.4	FINOCHIETTO INFANT ALUMINIUM, Rippensperrerr
BURFORD ALUMINIUM, Rippensperrerr	140.7	140.5
		FINOCHIETTO, Rippensperrerr
		140.11
C		G
Carotisklemme, COOLEY	142.42	Gefäßdilator, COOLEY
Carotis-Shuntklemme, JAVID	142.7	141.6
CASTANEDA ALUMINIUM, Rippensperrerr	140.8	Gefäßdilator, DE BAKEY
CASTANEDA, Neonatal-Gefäßklemme	142.51	141.5
Coarctationsklemme, POTTS	142.11, 142.12	Gefäßklemme, Kinder
COOLEY ALUMINIUM, Rippensperrerr	140.5	142.49, 142.50
COOLEY, Anastomosenklemme	142.42	Gefäßklemme, Kinder-, COOLEY
COOLEY, Carotisklemme	142.42	142.40, 142.41
COOLEY, Gefäßdilator	141.6	Gefäßklemme, Kinder-, DE BAKEY
COOLEY, Iliacaklemme	142.42	142.39, 142.40
COOLEY, Katheterklemme	142.10	Gefäßklemme, Kinder-, SUBRAMANIAN
COOLEY, Kinder-Gefäßklemme	142.40, 142.41	142.48
COOLEY, Mehrzweck-Gefäßklemme	142.43- 142.45	Gefäßklemme, Kinder-, SUBRAMANIAN-MINIATURE
COOLEY-BECK, Kinder-Aortaklemme	142.47	142.47
COOLEY-DERRA, Anastomosenklemme	142.46	Gefäßklemme, Mehrzweck-, BAINBRIDGE
		142.15
		Gefäßklemme, Mehrzweck-, COOLEY
		142.43- 142.45
		Gefäßklemme, Mehrzweck-, DARDIK
		142.4
		Gefäßklemme, Mehrzweck-, DE BAKEY .
		142.15, 142.30- 142.35
		Gefäßklemme, Mehrzweck-, GLOVER
		142.36
		Gefäßklemme, Mehrzweck-, POTTS
		142.28, 142.29
		Gefäßklemme, Neonatal, CASTANEDA
		142.51
		Gefäßklemme, Peripheral-, DALE
		142.5
		Gefäßklemme, Peripheral-, DE BAKEY
		142.13
		Gefäßklemme, Peripheral-, LELAND-JONES
		142.14
		Gefäßklemme, Peripheral-, MARTIN
		142.8, 142.9
		GIERTZ-STILLE, Rippenschere
		140.3
		GLOVER, Mehrzweck-Gefäßklemme
		142.36
		GLUCK, Rippenschere
		140. 2
		GREGORY, Profundaklemme
		142.6
D		H
DALE, Peripheral-Gefäßklemme	142.5	HAIGHT, Rippensperrerr
DARDIK, Mehrzweck-Gefäßklemme	142.4	140.8
DE BAKEY, Anastomosenklemme	142.37	HARKEN, Aurikelklemme
DE BAKEY, Aorta-Anastomosenklemme	142.25	142.23



Alphabetisches Verzeichnis

I

Iliacaklemme, COOLEY 142.42

J

JAVID, Carotis-Shuntklemme 142.7

K

Katheterklemme, COOLEY 142.10
 Kinder-Aortaklemme, COOLEY-BECK 142.47
 Kinder-Gefäßklemme 142.49, 142.50
 Kinder-Gefäßklemme, COOLEY 142.40, 142.41
 Kinder-Gefäßklemme, DE BAKEY 142.39, 142.40
 Kinder-Gefäßklemme, SUBRAMANIAN 142.48
 Kinder-Gefäßklemme, SUBRAMANIAN-MINIATURE 142.47
 Klemme, Anastomosen-, COOLEY 142.42
 Klemme, Anastomosen-, COOLEY-DERRA 142.46
 Klemme, Anastomosen-, DE BAKEY 142.37
 Klemme, Anastomosen-, DE BAKEY-BECK 142.38
 Klemme, Anastomosen-, DERRA 142.38
 Klemme, Aneurysma-, DE BAKEY-BAHNSON 142.27
 Klemme, Aorta-, DE BAKEY 142.19, 142.20
 Klemme, Aorta-, DIETRICH 142.3
 Klemme, Aorta-, MORRIS-DE BAKEY 142.26
 Klemme, Aorta-, OCHSNER 142.3
 Klemme, Aorta-, WEBER 142.21
 Klemme, Aorta-Anastomosen-, DE BAKEY 142.25
 Klemme, Aorta-Anastomosen-, LAMBERT-KAY 142.25
 Klemme, Aorta-Aneurysma-, DE BAKEY 142.16, 142.17
 Klemme, Aorta-Ligatur-, DE BAKEY 142.18
 Klemme, Arterien-, DE BAKEY-MOSQUITO 142.2, 142.32
 Klemme, Arterien-, DE BAKEY-PEAN 142.32, 142.33
 Klemme, Arterien-, DE BAKEY-RANKIN 142.2
 Klemme, Aurikel-, HARKEN 142.23
 Klemme, Bronchus-, LEES 142.24
 Klemme, Bronchus-, PRICE-THOMAS 141.2
 Klemme, Bronchus-, SEMB 141.2
 Klemme, Coarctations-, POTTS 142.11, 142.12
 Klemme, Katheter-, COOLEY 142.10
 Klemme, Ligatur-, DE BAKEY 142.19, 142.20
 Klemme, Profunda-, GREGORY 142.6
 Klemme, Tangential-, SATINSKY 142.22
 Knochenschere 140.2

L

LAMBERT-KAY, Aorta-Anastomosenklemme 142.25
 LEBSCHKE, Sternummeißel 140.4
 LEES, Bronchusklemme 142.24
 LELAND-JONES, Peripheral-Gefäßklemme 142.14
 Ligatur- und Präparierklemme, DE BAKEY 142.12
 Ligaturklemme, DE BAKEY 142.19, 142.20
 LOVELACE, Lungenfasszange 141.3
 Lungenfasszange, LOVELACE 141.3

M

MARTIN, Peripheral-Gefäßklemme 142.8, 142.9
 Mehrzweck-Gefäßklemme, BAINBRIDGE 142.15

Mehrzweck-Gefäßklemme, COOLEY 142.43- 142.45
 Mehrzweck-Gefäßklemme, DARDIK 142.4
 Mehrzweck-Gefäßklemme, DE BAKEY ... 142.15, 142.30- 142.35
 Mehrzweck-Gefäßklemme, GLOVER 142.36
 Mehrzweck-Gefäßklemme, POTTS 142.28, 142.29
 Meißel, Sternum-, LEBSCHKE 140.4
 MERCEDES Thoraxsperrer 140.14
 MORRIS-DE BAKEY, Aortaklemme 142.26
 MORSE FAVALORO ALUMINIUM, Rippensperrer 140.9
 MORSE FAVALORO, Rippensperrer 140.9

N

Neonatal- Gefäßklemme, CASTANEDA 142.51

O

OCHSNER, Aortaklemme 142.3

P

Peripheral-Gefäßklemme, DALE 142.5
 Peripheral-Gefäßklemme, DE BAKEY 142.13
 Peripheral-Gefäßklemme, LELAND-JONES 142.14
 Peripheral-Gefäßklemme, MARTIN 142.8, 142.9
 POTTS, Anastomosenklemme 142.12
 POTTS, Coarctationsklemme 142.11
 POTTS, Mehrzweck-Gefäßklemme 142.28, 142.29
 Präparier- und Ligaturklemme, DE BAKEY 142.12
 PRICE-THOMAS, Bronchusklemme 141.2
 Profundaklemme, GREGORY 142.6

R

Rippenkontraktor, BAILEY 140.16
 Rippenkontraktor, BAILEY-BABY 140.15
 Rippenkontraktor, BAILEY-GIBBON 140.16
 Rippenkontraktor, SELLORS 140.15
 Rippenschere 140.2
 Rippenschere, BETHUNE 140.3
 Rippenschere, BRUNNER 140.4
 Rippenschere, GIERTZ-STILLE 140.3
 Rippenschere, GLUCK 140.2
 Rippenschere, SAUERBRUCH 140.3
 Rippensperrer, BURFORD ALUMINIUM 140.7
 Rippensperrer, CASTANEDA ALUMINIUM 140.8
 Rippensperrer, COOLEY ALUMINIUM 140.5
 Rippensperrer, DE BAKEY 140.12, 140.13
 Rippensperrer, FINOCHIETTO 140.11
 Rippensperrer, FINOCHIETTO ALUMINIUM 140.6
 Rippensperrer, FINOCHIETTO BABY 140.11
 Rippensperrer, FINOCHIETTO BABY ALUMINIUM 140.6
 Rippensperrer, FINOCHIETTO INFANT ALUMINIUM 140.5
 Rippensperrer, HAIGHT 140.8
 Rippensperrer, MORSE FAVALORO 140.9
 Rippensperrer, MORSE FAVALORO ALUMINIUM 140.9
 Rippensperrer, TUFFIER 140.10
 RUMEL-BELMONT, Tourniquet 141.4

Alphabetisches Verzeichnis

S

SATINSKY, Tangentialklemme	142.22
SAUERBRUCH, Rippenschere.....	140.3
Schere, Knochen-.....	140.2
Schere, Rippen-	140.2
Schere, Rippen-, BETHUNE.....	140.3
Schere, Rippen-, BRUNNER.....	140.4
Schere, Rippen-, GIERTZ-STILLE.....	140.3
Schere, Rippen-, GLUCK	140.2
Schere, Rippen-, SAUERBRUCH.....	140.3
SELLORS, Rippenkontraktor.....	140.15
SEMB, Bronchusklemme	141.2
Sperrer, Rippen-, BURFORD ALUMINIUM.....	140.7
Sperrer, Rippen-, CASTANEDA ALUMINIUM	140.8
Sperrer, Rippen-, COOLEY ALUMINIUM	140.5
Sperrer, Rippen-, DE BAKEY.....	140.12, 140.13
Sperrer, Rippen-, FINOCHIETTO	140.11
Sperrer, Rippen-, FINOCHIETTO ALUMINIUM	140.6
Sperrer, Rippen-, FINOCHIETTO BABY	140.11
Sperrer, Rippen-, FINOCHIETTO BABY ALUMINIUM	140.6
Sperrer, Rippen-, FINOCHIETTO INFANT ALUMINIUM	140.5
Sperrer, Rippen-, HAIGHT	140.8
Sperrer, Rippen-, MORSE FAVALORO	140.9
Sperrer, Rippen-, MORSE FAVALORO ALUMINIUM.....	140.9
Sperrer, Rippen-, TUFFIER.....	140.10
Sperrer, Thorax-, MERCEDES.....	140.14
Sternummeißel, LEBSCHKE.....	140.4
SUBRAMANIAN, Kinder-Gefäßklemme	142.48
SUBRAMANIAN-MINIATURE, Kinder-Gefäßklemme	142.47

T

Tangentialklemme, SATINSKY.....	142.22
Thoraxsperrer, MERCEDES.....	140.14
Tourniquet, RUMEL-BELMONT.....	141.4
TUFFIER, Rippensperrer	140.10

W

WEBER, Aortaklemme.....	142.21
-------------------------	--------

Z

Zange, Lungen-, LOVELACE.....	141.3
-------------------------------	-------



Index, alphabetical

A	
anastomosis clamp, COOLEY.....	142.42
anastomosis clamp, COOLEY-DERRA.....	142.46
anastomosis clamp, DE BAKEY.....	142.37
anastomosis clamp, DE BAKEY-BECK.....	142.38
anastomosis clamp, DERRA.....	142.38
anastomosis clamp, POTTS.....	142.12
aneurysm clamp, aortic, DE BAKEY.....	142.16, 142.17
aneurysm clamp, DE BAKEY-BAHNSON.....	142.27
aorta-anastomosis clamp, DE BAKEY.....	142.25
aorta-anastomosis clamp, LAMBERT-KAY.....	142.25
aortic aneurysm clamp, DE BAKEY.....	142.16, 142.17
aortic clamp, DE BAKEY.....	142.19, 142.20
aortic clamp, DIETRICH.....	142.3
aortic clamp, MORRIS-DE BAKEY.....	142.26
aortic clamp, OCHSNER.....	142.3
aortic clamp, pediatric, COOLEY-BECK.....	142.47
aortic clamp, WEBER.....	142.21
aortic ligature forceps, DE BAKEY.....	142.18
auricle clamp, HARKEN.....	142.23
B	
BAILEY, rib contractor.....	140.16
BAILEY-BABY, rib contractor.....	140.15
BAILEY-GIBBON, rib contractor.....	140.16
BAINBRIDGE, multi purpose vascular clamp.....	142.15
BETHUNE, rib shears.....	140.3
bone shears.....	140.2
bronchus clamp, LEES.....	142.24
bronchus clamp, PRICE-THOMAS.....	141.2
bronchus clamp, SEMB.....	141.2
BRUNNER, rib shears.....	140.4
BURFORD ALUMINIUM, rib spreader.....	140.7
C	
carotid clamp, COOLEY.....	142.42
carotid shunt clamp, JAVID.....	142.7
CASTANEDA ALUMINIUM, rib spreader.....	140.8
CASTANEDA, neonatal vascular clamp.....	142.51
catcher, ligature.....	141.4
catheter clamp, COOLEY.....	142.10
chisel, sternum, LEBSCHER.....	140.4
coarctation clamp, POTTS.....	142.11
contractor, rib-, BAILEY.....	140.16
contractor, rib-, BAILEY-BABY.....	140.15
contractor, rib-, BAILEY-GIBBON.....	140.16
contractor, rib-, SELLORS.....	140.15
COOLEY ALUMINIUM, rib spreader.....	140.5
COOLEY, anastomosis clamp.....	142.42
COOLEY, carotid clamp.....	142.42
COOLEY, catheter clamp.....	142.10
COOLEY, iliac clamp.....	142.42
COOLEY, multi purpose vascular clamp.....	142.43- 142.45
COOLEY, pediatric vascular clamp.....	142.40, 142.41
COOLEY, vascular dilator.....	141.6
COOLEY-BECK, pediatric aortic clamp.....	142.47
COOLEY-DERRA, anastomosis clamp.....	142.46
D	
DALE, peripheral vascular clamp.....	142.5
DARDIK, multi purpose vascular clamp.....	142.4
DE BAKEY, anastomosis clamp.....	142.37
DE BAKEY, aorta-anastomosis clamp.....	142.25
DE BAKEY, aortic aneurysm clamp.....	142.16, 142.17
DE BAKEY, aortic clamp.....	142.19, 142.20
DE BAKEY, aortic ligature forceps.....	142.18
DE BAKEY, dissecting and ligature forceps.....	142.12
DE BAKEY, ligature forceps.....	142.19, 142.20
DE BAKEY, multi purpose vascular clamp.....	142.15, 142.30- 142.35
DE BAKEY, pediatric vascular clamp.....	142.39, 142.40
DE BAKEY, peripheral vascular clamp.....	142.13
DE BAKEY, rib spreader.....	140.12, 140.13
DE BAKEY, vascular dilator.....	141.5
DE BAKEY-BAHNSON, aneurysm clamp.....	142.27
DE BAKEY-BECK, anastomosis clamp.....	142.38
DE BAKEY-MOSQUITO, haemostatic forceps.....	142.2, 142.32
DE BAKEY-PEAN, haemostatic forceps.....	142.32, 142.33
DE BAKEY-RANKIN, haemostatic forceps.....	142.2
DERRA, anastomosis clamp.....	142.38
DIETRICH, aortic clamp.....	142.3
dilator, vascular-, COOLEY.....	141.6
dilator, vascular-, DE BAKEY.....	141.5
dissecting and ligature forceps, DE BAKEY.....	142.12
F	
FINOCHIETTO ALUMINIUM, rib spreader.....	140.6
FINOCHIETTO BABY ALUMINIUM, rib spreader.....	140.5
FINOCHIETTO INFANT ALUMINIUM, rib spreader.....	140.6
FINOCHIETTO, rib spreader.....	140.11
FINOCHIETTO-BABY, rib spreader.....	140.11
G	
garsping forceps, lung-, LOVELACE.....	141.3
GIERTZ-STILLE, rib shears.....	140.3
GLOVER, multi purpose vascular clamp.....	142.36
GLUCK, rib shears.....	140.2
GREGORY, profunda clamp.....	142.6
H	
haemostatic forceps, DE BAKEY-MOSQUITO.....	142.2, 142.32
haemostatic forceps, DE BAKEY-PEAN.....	142.32, 142.33
haemostatic forceps, DE BAKEY-RANKIN.....	142.2
HAIGHT, rib spreader.....	140.8
HARKEN, auricle clamp.....	142.23
I	
iliac clamp, COOLEY.....	142.42
J	
JAVID, carotid shunt clamp.....	142.7

Index, alphabetical

L

LAMBERT-KAY, aorta-anastomosis clamp	142.25
LEBSCHKE, sternum chisel	140.4
LEES, bronchus clamp	142.24
LELAND-JONES, peripheral vascular clamp	142.14
ligature catcher	141.4
ligature forceps, aortic, DE BAKEY	142.18
ligature forceps, DE BAKEY	142.19, 142.20
LOVELACE, lung grasping forceps	141.3
lung grasping forceps, LOVELACE	141.3

M

MARTIN, peripheral vascular clamp	142.8, 142.9
MERCEDES, thoracic retractor	140.14
MORRIS-DE BAKEY, aortic clamp	142.26
MORSE FAVALORO ALUMINIUM, rib spreader	140.9
MORSE FAVALORO, rib spreader	140.9
multi purpose vascular clamp, BAINBRIDGE	142.15
multi purpose vascular clamp, COOLEY	142.43- 142.45
multi purpose vascular clamp, DARDIK	142.4
multi purpose vascular clamp, DE BAKEY	142.15,
.....	142.30- 142.35
multi purpose vascular clamp, GLOVER	142.36
multi purpose vascular clamp, POTTS	142.28, 142.29

N

neonatal vascular clamp, CASTANEDA	142.51
occlusion clamp, tangential-, SATINSKY	142.22

O

OCHSNER, aortic clamp	142.3
-----------------------------	-------

P

pediatric aortic clamp, COOLEY-BECK	142.47
pediatric vascular clamp	142.49, 142.50
pediatric vascular clamp, COOLEY	142.40, 142.41
pediatric vascular clamp, DE BAKEY	142.39, 142.40
pediatric vascular clamp, SUBRAMANIAN	142.48
pediatric vascular clamp, SUBRAMANIAN-MINIATURE	142.47
peripheral vascular clamp, LELAND-JONES	142.14
peripheral vascular clamp, DALE	142.5
peripheral vascular clamp, DE BAKEY	142.13
peripheral vascular clamp, MARTIN	142.8, 142.9
POTTS, coarctation clamp	142.11, 142.12
POTTS, multi purpose vascular clamp	142.28, 142.29
PRICE-THOMAS, bronchus clamp	141.2
profunda clamp, GREGORY	142.6

R

retractor, thoracic-, MERCEDES	140.14
rib contractor, BAILEY	140.16
rib contractor, BAILEY-BABY	140.15
rib contractor, BAILEY-GIBBON	140.16
rib contractor, SELLORS	140.15
rib shears	140.2
rib shears, BETHUNE	140.3

rib shears, BRUNNER	140.4
rib shears, GIERTZ-STILLE	140.3
rib shears, GLUCK	140.2
rib shears, SAUERBRUCH	140.3
rib spreader, BURFORD ALUMINIUM	140.7
rib spreader, CASTANEDA ALUMINIUM	140.8
rib spreader, COOLEY ALUMINIUM	140.5
rib spreader, DE BAKEY	140.12, 140.13
rib spreader, FINOCHIETTO	140.11
rib spreader, FINOCHIETTO ALUMINIUM	140.6
rib spreader, FINOCHIETTO BABY ALUMINIUM	140.6
rib spreader, FINOCHIETTO INFANT ALUMINIUM	140.5
rib spreader, FINOCHIETTO-BABY	140.11
rib spreader, HAIGHT	140.8
rib spreader, MORSE FAVALORO	140.9
rib spreader, MORSE FAVALORO ALUMINIUM	140.9
rib spreader, TUFFIER	140.10
RUMEL-BELMONT, tourniquet	141.4

S

SATINSKY, tangential occlusion clamp	142.22
SAUERBRUCH, rib shears	140.3
SELLORS, rib contractor	140.15
SEMB, bronchus clamp	141.2
shears, bone	140.2
shears, rib	140.2
shears, rib, BETHUNE	140.3
shears, rib, BRUNNER	140.4
shears, rib, GIERTZ-STILLE	140.3
shears, rib, GLUCK	140.2
shears, rib, SAUERBRUCH	140.3
shunt clamp, carotid, JAVID	142.7
spreader, rib, BURFORD ALUMINIUM	140.7
spreader, rib, CASTANEDA ALUMINIUM	140.8
spreader, rib, COOLEY ALUMINIUM	140.5
spreader, rib, DE BAKEY	140.12, 140.13
spreader, rib, FINOCHIETTO	140.11
spreader, rib, FINOCHIETTO ALUMINIUM	140.6
spreader, rib, FINOCHIETTO BABY ALUMINIUM	140.6
spreader, rib, FINOCHIETTO INFANT ALUMINIUM	140.5
spreader, rib, FINOCHIETTO-BABY	140.11
spreader, rib, HAIGHT	140.8
spreader, rib, MORSE FAVALORO	140.9
spreader, rib, MORSE FAVALORO ALUMINIUM	140.9
spreader, rib, TUFFIER	140.10
sternum chisel, LEBSCHKE	140.4
SUBRAMANIAN, pediatric vascular clamp	142.48
SUBRAMANIAN-MINIATURE, pediatric vascular clamp	142.47

T

tangential occlusion clamp, SATINSKY	142.22
thoracic retractor, MERCEDES	140.14
tourniquet, RUMEL-BELMONT	141.4
TUFFIER, rib spreader	140.10



Index, alphabetical

V

vascular clamp, multi purpose, BAINBRIDGE.....	142.15
vascular clamp, multi purpose, COOLEY.....	142.43- 142.45
vascular clamp, multi purpose, DARDIK.....	142.4
vascular clamp, multi purpose, DE BAKEY.....	142.15, 142.30- 142.35
vascular clamp, multi purpose, GLOVER.....	142.36
vascular clamp, multi purpose, POTTS.....	142.28, 142.29
vascular clamp, neonatal, CASTANEDA.....	142.51
vascular clamp, pediatric.....	142.49, 142.50
vascular clamp, pediatric, COOLEY.....	142.40, 142.41
vascular clamp, pediatric, DE BAKEY.....	142.39, 142.40
vascular clamp, pediatric, SUBRAMANIAN.....	142.48
vascular clamp, pediatric, SUBRAMANIAN-MINIATURE...	142.47
vascular clamp, peripheral, DALE.....	142.5
vascular clamp, peripheral, DE BAKEY.....	142.13
vascular clamp, peripheral, LELAND-JONES.....	142.14
vascular clamp, peripheral, MARTIN.....	142.8, 142.9
vascular dilator, COOLEY.....	141.6
vascular dilator, DE BAKEY.....	141.5

W

WEBER, aortic clamp.....	142.21
--------------------------	--------