

intestinal and pylorus clamps

intestinal and tissue grasping forceps

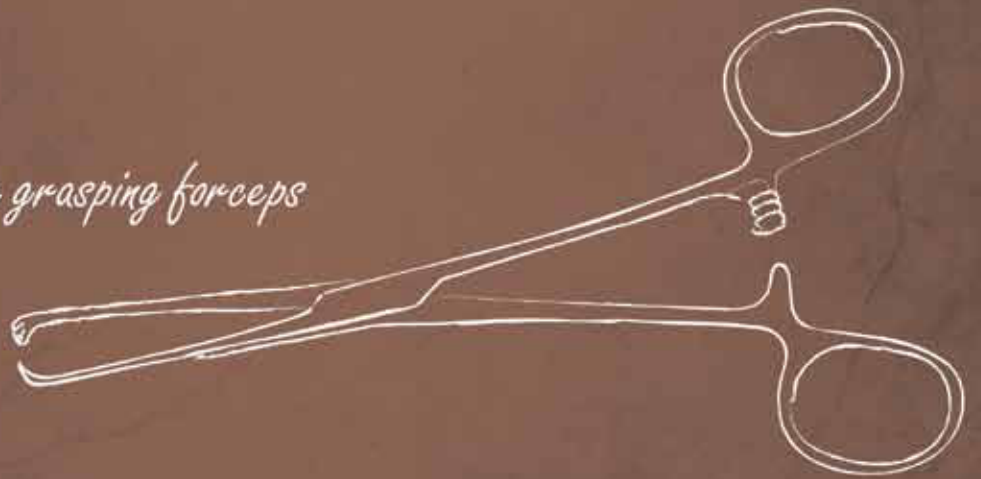





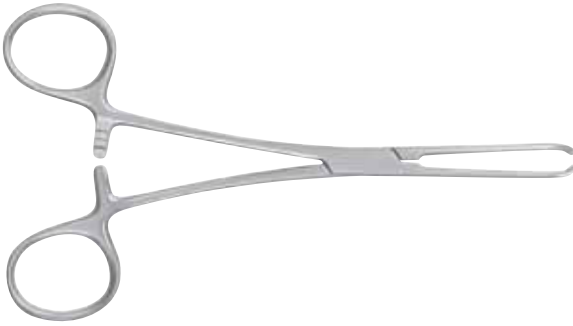

Magen; Darm; Mastdarm
Stomach; Intestines; Rectum

160

Darm- und Gewebefasszangen
 Intestinal and Tissue Grasping Forceps
 Pinzas para intestinos y tejidos

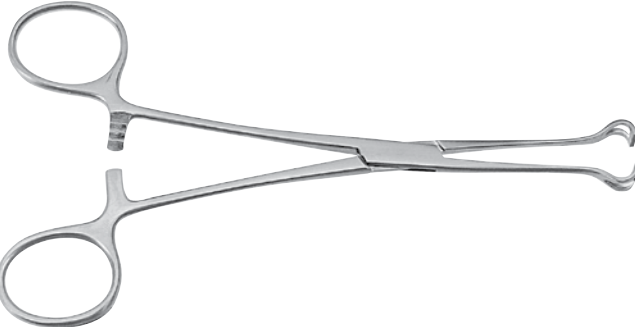
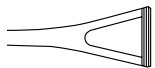

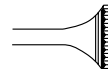
Art.Nr.	Beschreibung Description	Size	Spez.
	ALLIS-BABY		 4x5
160-000-12	12,5cm; 4 7/8"		
160-000-15	15,0cm; 5 7/8"		
	ALLIS		 5x6
160-004-15	15,0cm; 5 7/8"		
160-004-19	19,0cm; 7 4/8"		
160-004-25	25,0cm; 9 7/8"		
	BABCOCK		
160-006-16	16,0cm; 6 2/8"		
160-006-18	18,0cm; 7 1/8"		
160-006-20	20,0cm; 7 7/8"		
160-006-24	24,0cm; 9 4/8"		
160-010-15	ALLIS-ADAIR	15,0cm; 5 7/8"	 10x11
			

160

Darm- und Gewebefasszangen
 Intestinal and Tissue Grasping Forceps
 Pinzas para intestinos y tejidos

Art.Nr.	Beschreibung Description	Size	Spez.
---------	----------------------------	------	-------

160-012-15	BOYS-ALLIS	15,0cm; 5 7/8"	 5x6
------------	------------	----------------	---



160-014-20	ALLIS	20,0cm; 7 7/8"	 5x6
------------	-------	----------------	---

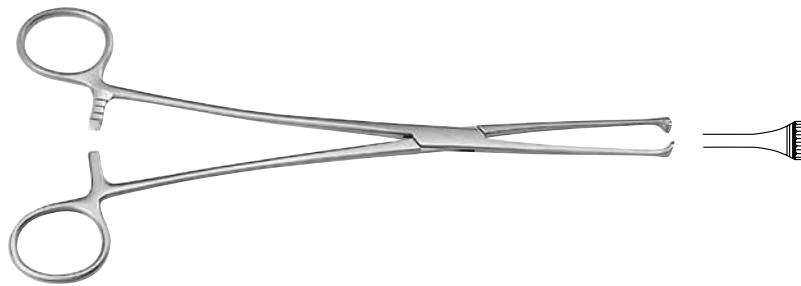

160-020-15	ALLEN	15,5cm; 6"	 1x2
------------	-------	------------	---

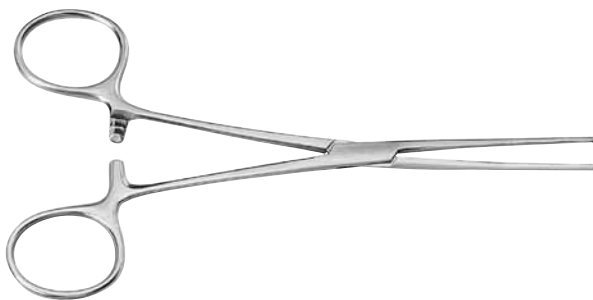

	JUDD-ALLIS		 3x4
--	------------	--	---

160-040-15	15,0cm; 5 7/8"
------------	----------------

160-040-19	19,0cm; 7 4/8"
------------	----------------



Darm- und Gewebefasszangen
 Intestinal and Tissue Grasping Forceps
 Pinzas para intestinos y tejidos



Art.Nr.	Beschreibung Description	Size	Spez.
160-050-20	THOMS-ALLIS	20,0cm; 7 7/8"	 6x7

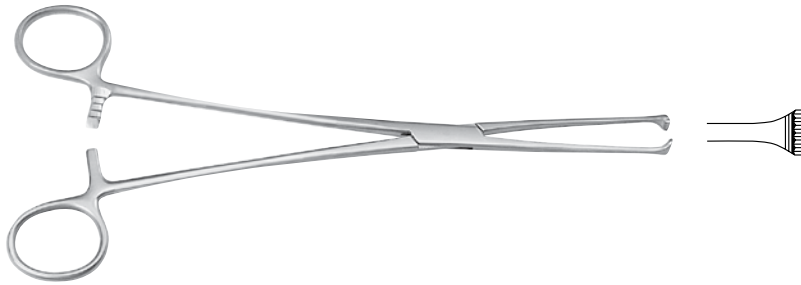

160-070-16	WILLIAMS	16,0cm; 6 2/8"
------------	----------	----------------



DUVAL

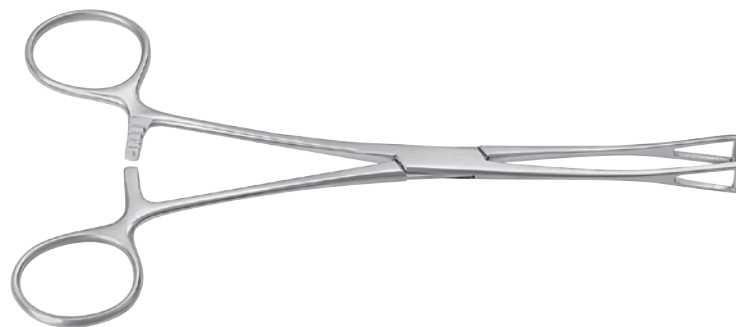

160-170-18 18,0cm; 7 1/8"

160-170-20 20,0cm; 7 7/8"

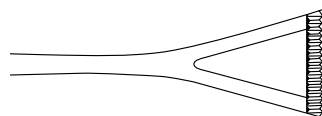

160-172-20 20,0cm; 7 7/8"

160-172-23 23,0cm; 9"

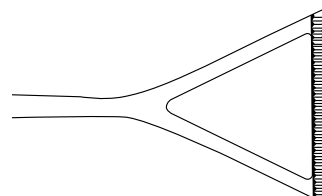

160

Darm- und Gewebefasszangen
 Intestinal and Tissue Grasping Forceps
 Pinzas para intestinos y tejidos

Art.Nr.	Beschreibung Description	Size	Spez.
---------	----------------------------	------	-------

160-176-20 LOCKWOOD

20,0cm; 7 7/8"

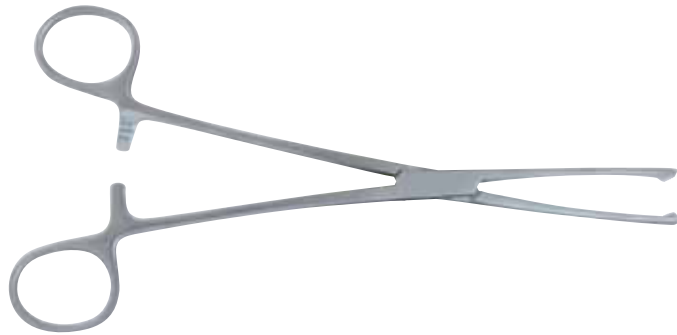

BABCOCK

TC

160-180-16 16,5cm; 6 4/8"

160-180-20 21,0cm; 8 2/8"

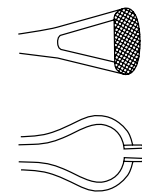
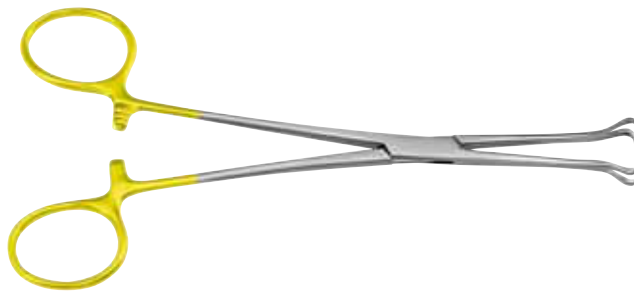

160-190-20 DUVAL

20,0cm; 7 7/8"

TC



Darmklemmen
 Intestinal Clamps
 Pinzas intestinales



Art.Nr. Beschreibung | Description Size Spez.

DOYEN-BABY

18,0cm; 7 1/8"

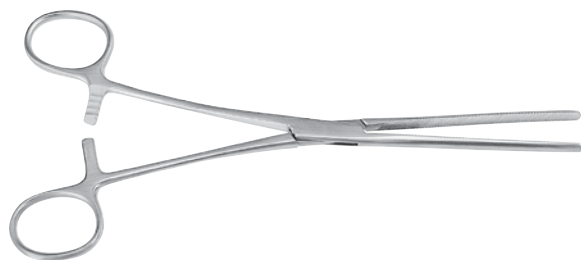

160-200-18



160-201-18

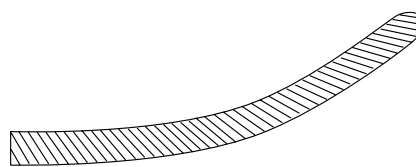

DOYEN



160-210-21

21,0cm; 8 2/8"



160-210-23

23,0cm; 9"

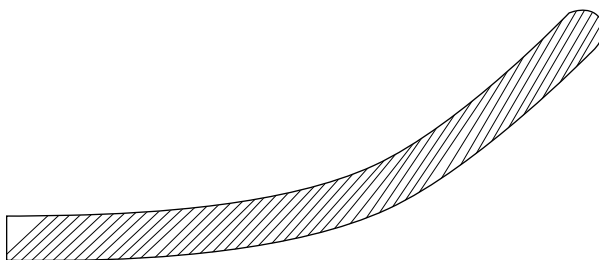

160-211-21

21,0cm; 8 2/8"

160-211-23

23,0cm; 9"

160-240-24

BRUNNER

24,0cm; 9 4/8"

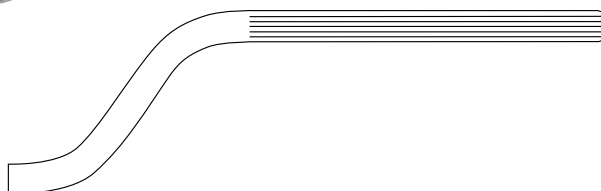

160

Art.Nr. Beschreibung | Description Size Spez.

MAYO-ROBSON

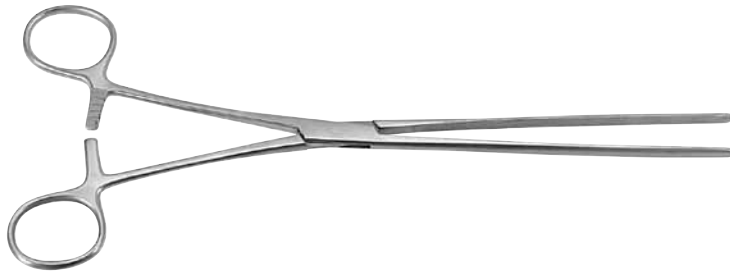

- 160-230-21 21,5cm; 8 4/8"
- 160-230-23 23,5cm; 9 2/8"
- 160-230-25 25,5cm; 10"

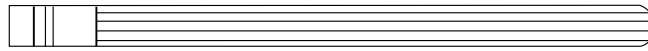

- 160-231-21 21,5cm; 8 4/8"
- 160-231-23 23,0cm; 9"
- 160-231-25 24,5cm; 9 5/8"

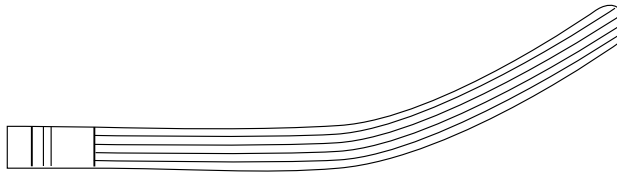

KOCHER

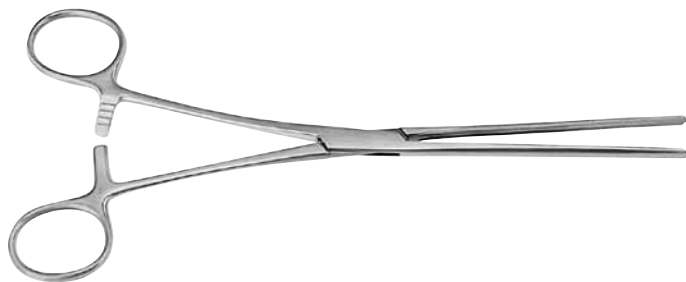

- 160-234-22 22,5cm; 8 7/8"
- 160-234-25 25,0cm; 9 7/8"
- 160-234-28 28,0cm; 11,2"

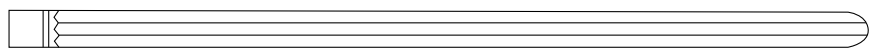

- 160-235-22 22,0cm; 8 5/8"
- 160-235-25 25,0cm; 9 7/8"
- 160-235-28 27,5cm; 10 6/8"

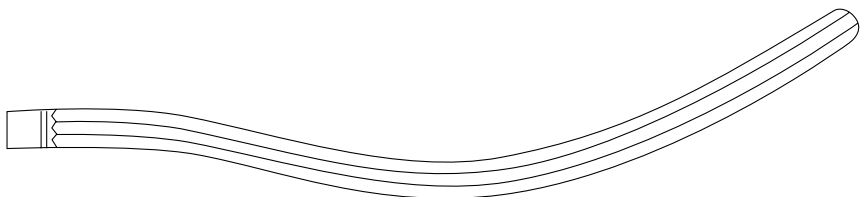

Darmquetschklemmen
 Intestinal and Pylorus Clamps
 Pinzas intestinales para piloro



Art.Nr.	Beschreibung Description	Size	Spez.
---------	----------------------------	------	-------

160-310-15	PAYR-BABY mit Stift with pin con espiga	15,0cm; 6"	
------------	---	------------	--

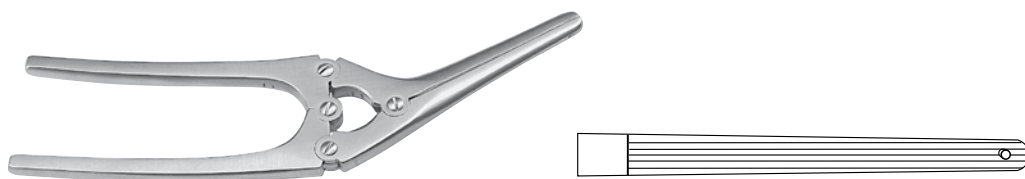

PAYR	mit Stift with pin con espiga		
------	-------------------------------------	--	--



160-310-21	21,0cm; 8 2/8"		
160-310-29	29,0cm; 11 3/8"		
160-310-35	34,0cm; 13 3/8"		

Darm-Anastomosenklemmen
 Intestinal Anastomosis Clamps
 Clamps para anastomosis intestinales

Art.Nr.	Beschreibung Description	Size	Spez.
	DE MARTEL-WOLFSON Pack á 3 Stück set with 3 pieces paquete con 3 piezas		

- 160-320-05 50 mm
- 160-320-07 70 mm
- 160-320-10 100 mm



160-325-26	DE MARTEL-WOLFSON Klemmschließzange closing forceps pinza para cerrar grapas	25,0cm; 9 7/8"	
------------	--	----------------	--



160-340-08	DE MARTEL-WOLFSON Klemmenhalter clamp holder porta-clamp	9,5cm; 3 6/8"	
------------	--	---------------	--



160-340-23	DE MARTEL-WOLFSON Klemmenhalter clamp holder porta-clamp	23,0cm; 9"	
------------	--	------------	--



Darm-Anastomosenklemmen
 Intestinal Anastomosis Clamps
 Clamps para anastomosis intestinales



Art.Nr.	Beschreibung Description	Size	Spez.
160-342-15	BENSON Pylorusspreizer pylorus Spreader separador para piloro	15,5cm; 6 1/8"	



STONE-WATT



160-345-07	8,5cm; 3 3/8"
160-345-10	11,0cm; 4 3/8"

160-347-15	STONE-WATT Schließklemme closing Forceps pinza para cerrar clamps	16cm; 6 2/8"	
------------	--	--------------	--



Magen- und Darm-Zwillingsklemmen
 Stomach and Intestinal Anastomosis Twin Clamps
 Pinzas gastro-intestinales gemales

Art.Nr.	Beschreibung Description	Size	Spez.
	LANE	30,0cm; 11 6/8"	

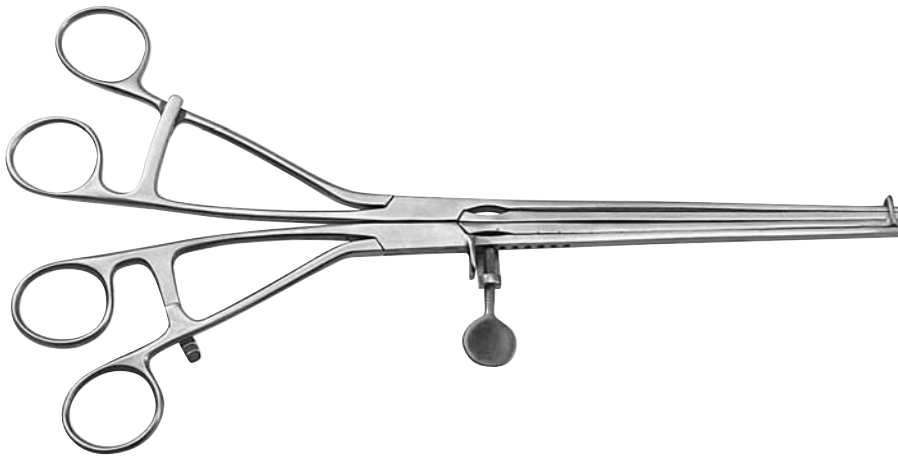

160-360-30







160-361-30

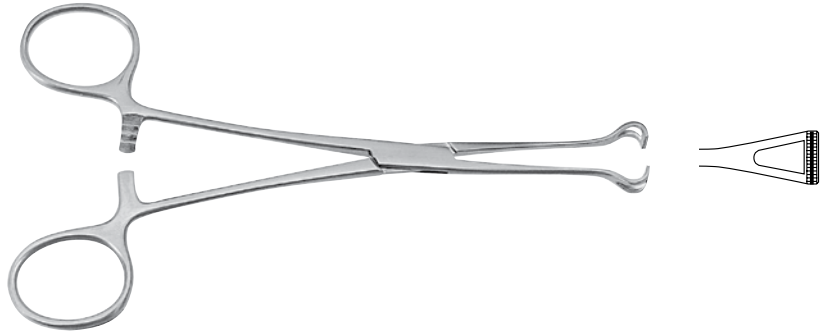

Darm- und Gewebefasszangen
 Intestinal and Tissue Grasping Forceps
 Pinzas para intestinos y tejidos

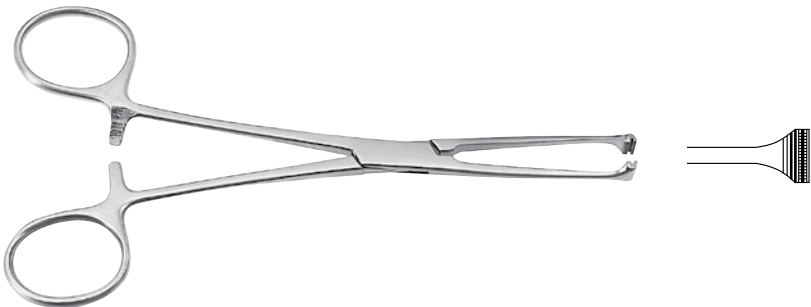

Art.Nr.	Beschreibung Description	Size	Spez.
	BABCOCK		ATRAUMA
164-006-16	16,0cm; 6 2/8"		
164-006-20	20,0cm; 7 7/8"		
	ALLIS		ATRAUMA
164-124-16	16,0cm; 6 2/8"		
164-124-20	20,0cm; 7 7/8"		
164-124-25	25,0cm; 9 7/8"		
164-124-30	30,0cm; 12"		

164

Art.Nr.	Beschreibung Description	Size	Spez.
---------	----------------------------	------	-------

DOYEN

ATRAUMA

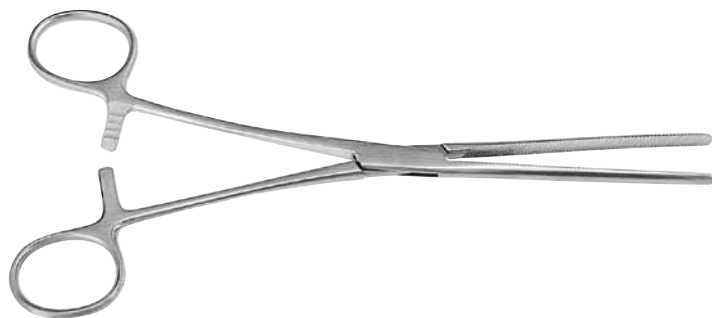

164-210-16 16,0cm; 6 2/8"

164-210-18 18,0cm; 7"

164-210-21 21,0cm, 8 2/8"

164-210-23 23,0cm, 9"

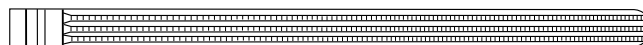

164-211-16 16,0cm; 6 2/8"

164-211-18 18,0cm; 7"

164-211-21 21,0cm, 8 2/8"

164-211-23 23,0cm, 9"

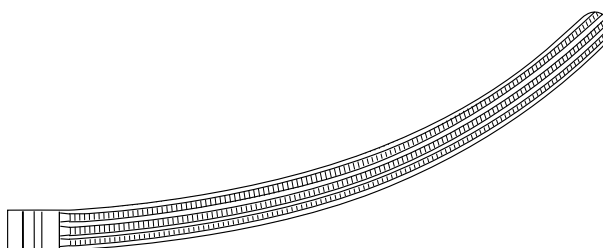

Darmklemmen
 Intestinal Clamps
 Pinzas intestinales



Art.Nr.	Beschreibung Description	Size	Spez.
---------	----------------------------	------	-------

MAYO-ROBSON

25,0cm; 9 2/8"

ATRAUMA



164-230-25

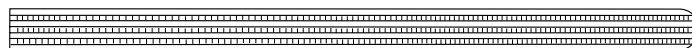

164-231-25

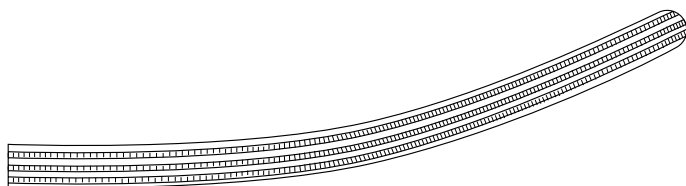

KOCHER

ATRAUMA

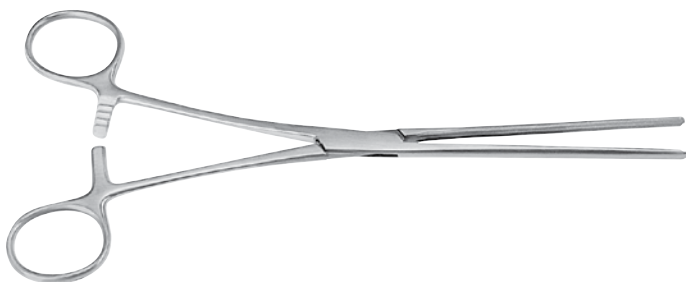

164-234-22

22,0cm; 8 5/8"

164-234-25

25,0cm; 9 7/8"

164-234-28

28,0cm; 11"



164-235-22

22,0cm; 8 5/8"

164-235-25

25,0cm; 9 7/8"

164-235-28

28,0cm; 11"

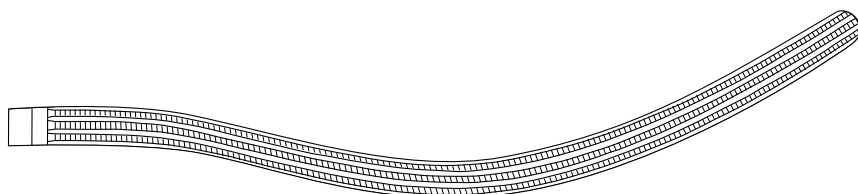

164

Darmklemmen
Intestinal Clamps
Pinzas intestinales

Art.Nr.	Beschreibung Description	Size	Spez.
---------	----------------------------	------	-------

KOCHER-BABY

13,0cm; 5 1/8"

ATRAUMA

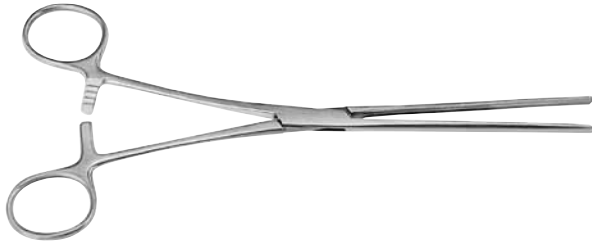

164-238-13

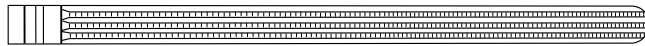

164-239-13

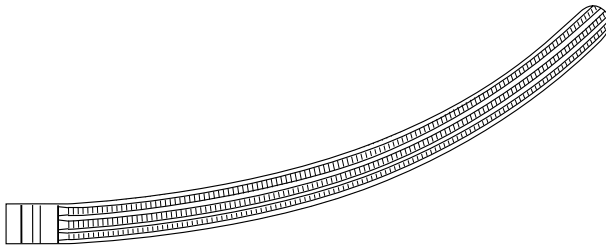

164-240-24

BRUNNER

27,0cm; 10 6/8"

ATRAUMA

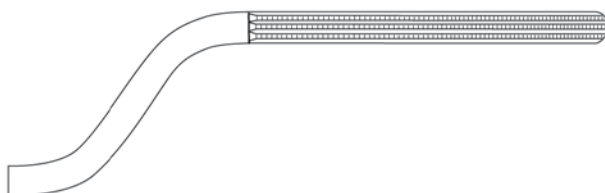

Darmklemmen
Intestinal Clamps
Pinzas intestinales



Art.Nr.	Beschreibung Description	Size	Spez.
---------	----------------------------	------	-------

SCUDDER

33,0cm; 13"

ATRAUMA



164-364-33



164-365-33

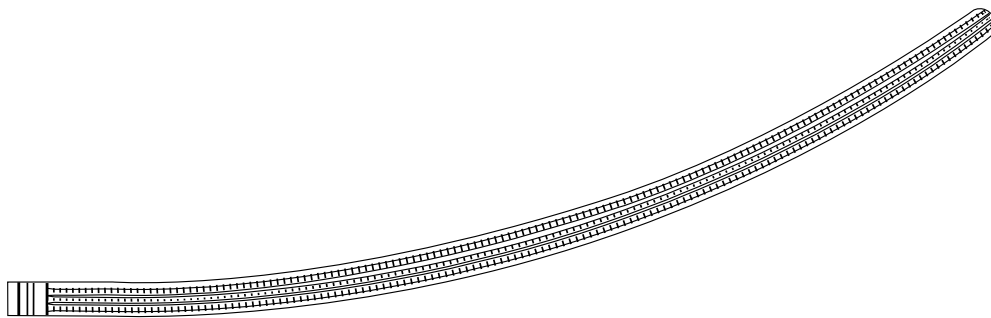

164

Rektumklemmen
Sigmoid Anastomosis Clamps
Pinzas para anastomosis rectales

Art.Nr.	Beschreibung Description	Size	Spez.
164-370-30	RESANO	28,0cm; 11"	ATRAUMA

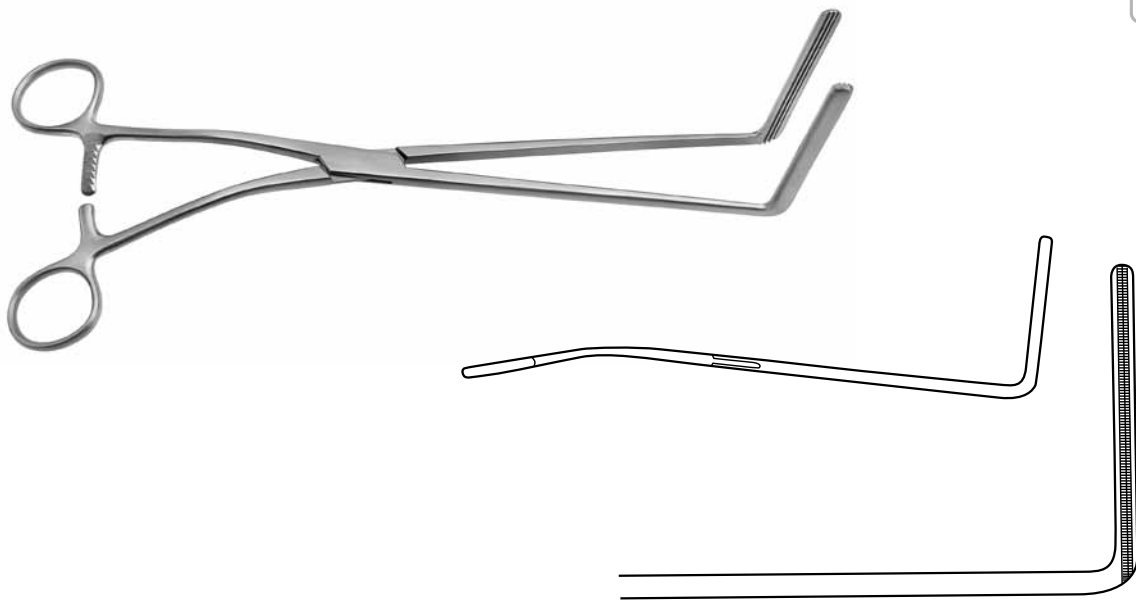

164-374-24	FEHLAND	24,0cm; 9 4/8"	ATRAUMA
------------	---------	----------------	---------

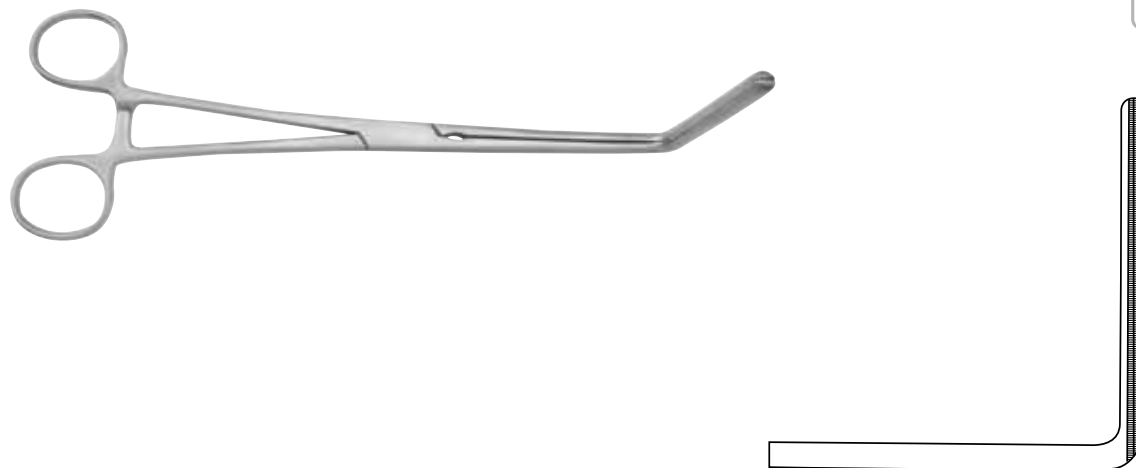

Rektum-Anastomosenklemmen
 Sigmoid Anastomosis Clamps
 Pinzas para anastomosis rectales



Art.Nr.	Beschreibung Description	Size	Spez.
HAYES			
164-376-26	26,0cm; 10 2/8"		<div style="border: 1px solid black; padding: 2px; text-align: center;"> ATRAUMA </div>
164-376-28	28,0cm; 11"		

164

Mastdarmspekula
Rectal Specula
Espéculos rectales



Art.Nr.	Beschreibung Description	Size	Spez.
168-018-22	CZERNY	22,5cm; 8 7/8"	



105 x 23-28 mm

Mastdarmspekula
Rectal Specula
Espéculos rectales

Art.Nr.	Beschreibung Description	Size	Spez.
168-046-21	PRATT	21,5cm; 8 4/8"	



85 x 25 mm

168-108-15	SIMS	15,5cm; 6 1/8"	
------------	------	----------------	--



17 x 89 mm

168-110-15	SIMS	15,5cm; 6 1/8"	
------------	------	----------------	--



17 x 89 mm

Analspreizer
 Rectal Spreaders
 Separadores rectales



Art.Nr.	Beschreibung Description	Size	Spez.
168-147-00	ALAN PARKS mit Valven und Flügelmutter with valves and wing nut con valvas laterales y valva centrale	14,0cm; 5,6"	SET

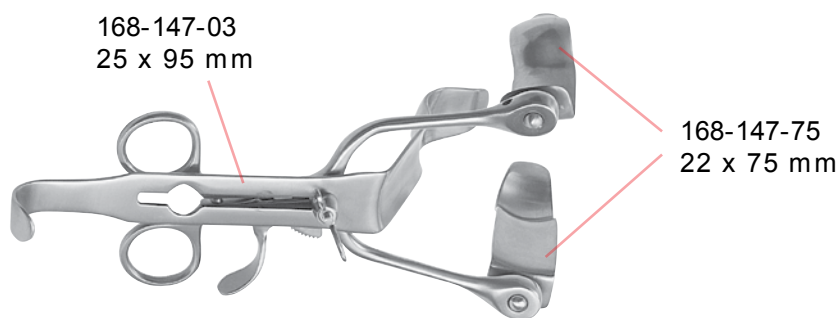

168-147-03	Mittelvalve allein central blade only valva central	25 x 95 mm
------------	---	------------

168-147-75	Seitenvalven; Paar lateral blades; pair valvas laterales; par	22 x 75 mm
------------	---	------------

168-147-95	Seitenvalven; Paar lateral blades; pair valvas laterales; par	22 x 95 mm
------------	---	------------



168-200-00	Kaltlichtaufsatz cold light carrier portador de luz fria
------------	--



Anoskop; Sphinkterskope
 Anuscope; sphincteroscopes
 Anoscopio; esfincteroscopio

Art.Nr.	Beschreibung Description	Size	Spez.
	IVES FANSLER	Ø 22 mm	



168-268-01 ohne Kaltlichtträger
 without cold light
 sin luz fría

168-268-02 mit Kaltlichtträger
 with cold light
 con luz fría

KELLY

168-285-21 Ø 21 x 50 mm



168-285-27 Ø 27 x 50 mm



Biopsiezangen
 Biopsy Forceps
 Pinza para biopsia



Art.Nr.	Beschreibung Description	Size	Spez.
	drehbarer Schaft rotating shaft giratorio vástago	41,0cm; 16 1/8"	



168-370-41

YEOMAN

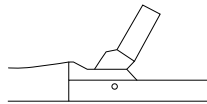
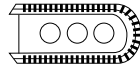

168-375-41

TURREL

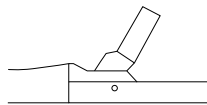
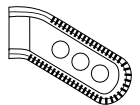

168-380-41

YEOMAN

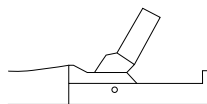

168-385-41

TURREL

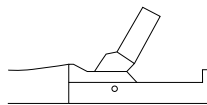
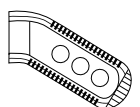

168

Hämorrhoidal-Ligatoren
Hemorrhoidal Ligator
Ligador para hemorroides

Art.Nr.	Beschreibung Description	Size	Spez.
168-400-00	RUDD komplett mit Ladekonus complete with loading cone completo con cono de carga	27,5cm; 10 7/8"	

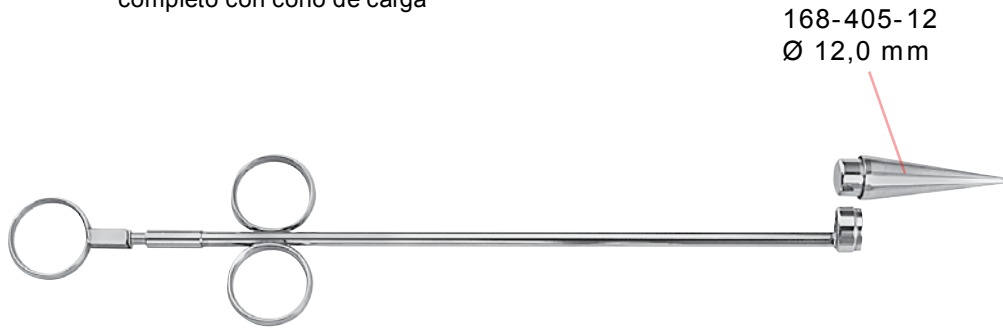

168-405-12	RUDD Ladekonus allein loading cone only cono de carga		
------------	---	--	--

168-415-00	Ligatur-Gummiringe; Packung mit 100 Stück Rubber rings box with 100 pieces Anillos de goma Paquete con 100 piezas		
------------	---	--	--

Hämorrhoidal Faszangen
Hemorrhoidal Ligatur Forceps
Ligador para hemorroides



Art.Nr.	Beschreibung Description	Size	Spez.
168-471-19	MC GIVNEY	19,0cm; 7 4/8"	

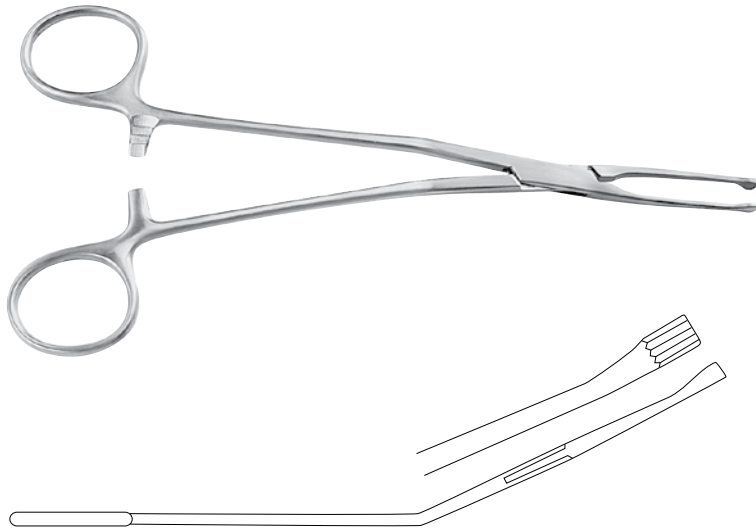

168-473-19	MC GIVNEY	19,0cm; 7 4/8"	
------------	-----------	----------------	--

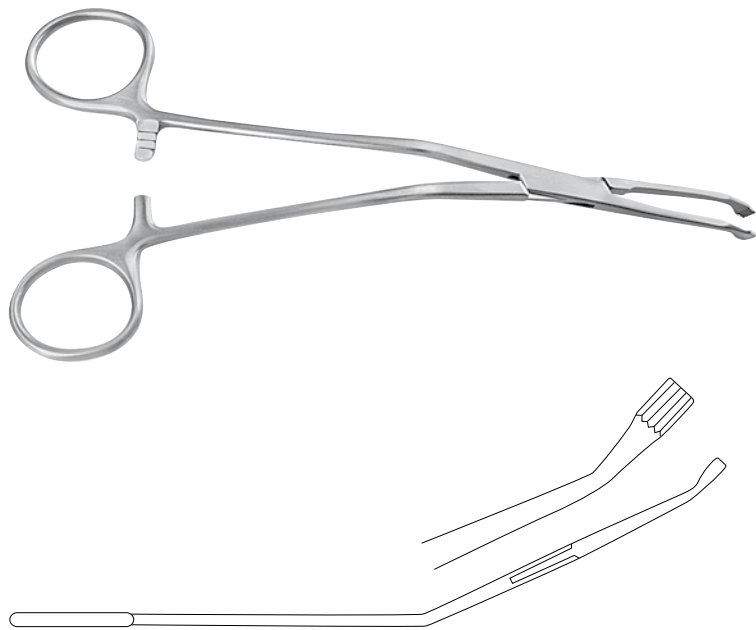

Weitere Artikel
further items
más artículos

Art.Nr.	Beschreibung Description	Size	Spez.
Other items available but not illustrated			
160-004-22	ALLIS Intestinal grasping forceps straight; 5x6 teeth	22,0cm; 8,8"	
160-004-24	straight; 5x6 teeth	24,0cm; 9,6"	
160-020-20	ALLEN Intestinal clamp straight; 1x2 teeth	20,0cm; 8"	
160-020-23	straight; 1x2 teeth	23,0cm; 9,2"	
160-052-20	THOMS-ALLIS Intestinal grasping forceps; straight; 7x8 teeth	20,0cm; 8"	
160-060-18	LITTLE-WOOD Intestinal grasping forceps straight; 2x3 teeth	18,5cm; 7,4"	
160-172-30	DUVAL Intestinal grasping forceps straight; atraumatic; 25 mm	30,0cm; 12"	
160-174-23	straight; big; serrated	23,0cm; 9,2"	
160-178-16	LOCKWOOD Intestinal grasping forceps straight; serrated	16,0cm; 6,4"	
160-178-20	straight; serrated	20,0cm; 8"	
160-200-16	BABY-DOYEN Intestinal clamp straight; diagonally serrated	16,5cm; 6,6"	
160-201-16	curved; diagonally serrated		
160-238-13	BABY-KOCHER Intestinal clamp straight; serrated longitudinal	13,0cm; 5,2"	
160-239-13	curved; serrated longitudinal		
160-253-23	GLASSMAN Intestinal clamp 90° angled; serrated	23,5cm; 9,4"	
160-259-23	60° angled; serrated	23,0cm; 9,2"	
160-311-15	PAYR-BABY Intestinal and Pylorus clamp; without pin	15,0cm; 6"	
160-311-21	PAYR Intestinal and Pylorus clamp without pin	21,0cm; 8,4"	
160-311-29	without pin	29,0cm; 11,6"	
160-311-35	without pin	35,0cm; 14"	
160-320-12	DE MARTEL-WOLFSON Intestinal clamp straight; jaw length 120mm; Set with 3 pieces		
160-346-00	STONE-WATT Locking device		
160-358-36	HABERER stomach clamp	36,0c; 14,4"	
160-364-25	SCUDDER Intestinal clamp; straight; serrated	25,0cm; 10"	
160-364-33		33,0cm; 13,2"	

Weitere Artikel
 further items
 más artículos



Art.Nr.	Beschreibung Description	Size	Spez.
Other items available but not illustrated			
160-365-25 160-365-33	SCUDDER Intestinal clamp; curved; serrated	25,0cm; 10" 33,0cm; 13,2"	
160-372-31	LLOYD-DAVIS Anastomosis clamps curved; serrated longitudinal	31,5cm; 12,6"	
160-376-01 160-376-02	Anastomosis clamps curved; serrated longitudinal; 60mm curved; serrated longitudinal; 80mm	23,0cm; 9,2"	
160-500-00	PETZ suturing Apparatus; complete		
160-500-01	PETZ suturing Apparatus; complete; in wooden case		
160-500-10	Clamps for PETZ suturing Apparatus; Package of 300 pcs.		

Weitere Artikel
further items
más artículos

Art.Nr.	Beschreibung Description	Size	Spez.
Other items available but not illustrated			
164-006-30	BABCOCK Intestinal grasping forceps; straight; atraumatic	30,0cm; 12"	
164-124-22	ALLIS Intestinal grasping forceps; straight; atraumatic	22,0cm; 8,8"	
164-214-13	DOYEN-BABY Intestinal clamp straight; atraumatic	13,0cm; 5,2"	
164-214-17	DOYEN-BABY Intestinal clamp straight; atraumatic	17,0cm; 6,8"	
164-224-15	BAINBRIDGE Intestinal clamp straight; atraumatic	15,0cm; 6"	
164-224-18	BAINBRIDGE Intestinal clamp straight; atraumatic	18,0cm; 7,2"	
164-225-15	BAINBRIDGE Intestinal clamp curved; atraumatic	15,0cm; 6"	
164-225-18	BAINBRIDGE Intestinal clamp curved; atraumatic	18,0cm; 7,2"	
164-230-21	MAYO-ROBSON Intestinal clamp straight; atraumatic	21,0cm; 8,4"	
164-230-23	MAYO-ROBSON Intestinal clamp straight; atraumatic	23,0cm; 9,2"	
164-231-21	MAYO-ROBSON Intestinal clamp curved; atraumatic	21,0cm; 8,4"	
164-231-23	MAYO-ROBSON Intestinal clamp curved; atraumatic	23,0cm; 9,2"	
164-378-30	KERSTING Anastomosis clamp curved; atraumatic	30,0cm; 12"	
164-382-25	DICK Anastomosis clamp; curved; atraumatic	25,5cm; 10,2"	
164-382-26	DICK Anastomosis clamp; curved; atraumatic	26,5cm; 10,6"	
164-382-27	DICK Anastomosis clamp; curved; atraumatic	27,5cm; 11"	

Weitere Artikel
further items
más artículos



Art.Nr.	Beschreibung Description	Size	Spez.
Other items available but not illustrated			
168-000-02	Lightpost for MORGAN proctoscope to be adapted to cable		
168-010-19	MILKULICZ sigmoid anastomosis clamp	19,0cm; 7,6"	
	SAWYER rectal specula		
168-030-01	64x22mm	27,0cm; 10,8"	
168-030-02	75x30mm	28,0cm; 11,2"	
168-030-03	89x38mm	28,0cm; 11,2"	
	SCHULZE-BERGMANN rectal specula		
168-040-06		6,0cm; 2,4"	
168-040-08		8,0cm; 3,2"	
168-040-12		12,5cm; 5"	
168-040-15		15,0cm; 6"	
168-046-16	PRATT rectal specula; 57x18mm	16,5cm; 6,6"	
	FANSLER anoscope		
168-124-25	Ø 25x65mm		
168-124-29	Ø 29x65mm		
168-124-38	Ø 38x70mm		
168-147-02	ALAN PARKS rectal retractor only		
	blades only; pair; for ALAN PARKS		
168-147-10			
168-147-20			
168-147-30			
168-150-21	MATHIEU rectal specula; 90x15mm	19,5cm; 7,8"	
168-160-15	SMITH-BUIE anal retractor; 75x23mm	15,0cm; 6"	
	HIRSCHMANN anoscope; with obturator		
168-212-01	16x65mm		
168-212-02	19x65mm		
168-212-03	22x65mm		
168-212-16	16X65mm		
168-212-19	19X65mm		
168-212-22	22X65mm		
168-212-23	22X125mm		
	MORGAN proctoscope		
168-220-01	Ø 17x65mm		
168-220-02	Ø 17x80mm		
168-220-03	Ø 20x65mm		
168-220-04	Ø 20x80mm		
168-220-05	Ø 24x65mm		
168-220-06	Ø 24x80mm		

Weitere Artikel
further items
más artículos

Art.Nr.	Beschreibung Description	Size	Spez.
Other items available but not illustrated			
168-220-19	BENSAUDE anoscope; with obturator 17x70mm		
168-220-22	22x70mm		
168-250-22	CHELSEA EATON anoscope Ø 22 x 65 mm		
168-250-30	Ø 30 x 65 mm		
168-268-95	fiber optic light carrier for IVES FANSR		
168-280-01	KELLY proctoscope; with obturator 22x50mm		
168-280-02	22x100mm		
168-280-03	22x140mm		
168-280-04	22x200mm		
168-280-05	22x50mm		
168-280-10	22x100mm		
168-280-14	22x140mm		
168-280-20	22x200mm		
168-285-01	KELLY sphincteroscope 21x50mm		
168-285-02	27x50mm		
168-310-28	YEOMAN rectal biopsy forceps; fig. 3	28,0cm; 11,2"	
168-310-35		35,0cm; 13,8"	
168-310-42		42,0cm; 16,6"	
168-311-23	YEOMAN Biopsy Forceps 9" (22.9cm) shaft 3.5x10mm bite, with basket	23,0cm; 9,2"	
168-311-28	YEOMAN rectal biopsy forceps; fig. 2	28,0cm; 11,2"	
168-311-33	YEOMAN Biopsy Forceps 13" (33cm) shaft 3.5x10mm bite, with basket		
168-311-35	YEOMAN rectal biopsy forceps; fig. 2	35,0cm; 13,8"	
168-311-38	YEOMAN Biopsy Forceps 15" (38.1cm) shaft 3.5x10mm bite, with basket		
168-311-42	YEOMAN rectal biopsy forceps fig. 2	42,0cm; 16,6"	
168-312-28	fig. 4	28,0cm; 11,2"	
168-312-35	fig. 4	35,0cm; 13,8"	
168-312-42	fig. 4	42,0cm; 16,6"	

Weitere Artikel
further items
más artículos



Art.Nr.	Beschreibung Description	Size	Spez.
Other items available but not illustrated			
168-330-35 168-330-45	rectoscopy-foreign-body grasping forceps; tube shaft; straight; ring handle	35,0cm; 13,8" 45,0cm; 17,8"	
168-334-35 168-334-45	rectal biopsy forceps; oval jaw; tube shaft; straight; ring handle	35,0cm; 13,8" 45,0cm; 17,8"	
168-335-35 168-335-45	rectal biopsy forceps; oval jaw; tube shaft; left angled; ring handle	35,0cm; 13,8" 45,0cm; 17,8"	
168-340-35 168-340-45	rectal biopsy forceps; through cutting; tube shaft; straight; ring handle	35,0cm; 13,8" 45,0cm; 17,8"	
168-341-35 168-341-45	rectal biopsy forceps; through cutting; tube shaft; left angled; ring handle	35,0cm; 13,8" 45,0cm; 17,8"	
168-360-23 168-360-33	YEOMAN biopsy forceps; straight; rotating shaft; ring handle	23,0cm; 9,2" 33,0cm; 13"	
168-360-33/A	YEOMAN biopsy forceps, insert only straight; rotating shaft; ring handle	33,0cm; 13"	
168-360-41	YEOMAN biopsy forceps; straight; rotating shaft; ring handle	41,0cm; 16,2"	
168-360-41/A	YEOMAN biopsy forceps, insert only; straight, no teeth, ring handle	41,0cm; 16,2"	
168-361-41	YEOMAN biopsy forceps; rotating shaft; only; straight	41,0cm; 16,2"	
168-365-23	YEOMAN biopsy forceps; angled; rotating shaft; ring handle	23,0cm; 9,2"	
168-365-23/A	TURREL biopsy forceps; curved; toothed; rotating shaft	23,0cm; 9,2"	
168-365-33	YEOMAN biopsy forceps; curved; rotating shaft; ring handle	33,0cm; 13"	
168-365-33/A	TURREL biopsy forceps, insert only; curved; rotating shaft, no teeth	33,0cm; 13"	
168-365-41	YEOMAN biopsy forceps; curved; rotating shaft; ring handle	41,0cm; 16,2"	
168-365-41/A	TURREL biopsy forceps, insert only; curved; rotating shaft, without teeth	41,0cm; 16,2"	
168-370-23 168-370-33	YEOMAN biopsy forceps; straight: rotating shaft	23,0cm; 9,2" 33,0cm; 13"	

Weitere Artikel
further items
más artículos

Art.Nr.	Beschreibung Description	Size	Spez.
Other items available but not illustrated			
168-370-33/A	YEOMAN biopsy forceps, insert only; straight; no teeth, rotating shaft	33,0cm; 13"	
168-370-41/A	YEOMAN biopsy forceps, insert only; straight; rotating shaft, no teeth	41,0cm; 16,2"	
168-375-23	TURREL biopsy forceps; curved; rotating shaft	23,0cm; 9,2"	
168-375-23/A	TURREL biopsy forceps, insert only; curved; rotating shaft	23,0cm; 9,2"	
168-375-33	TURREL biopsy forceps; curved; rotating shaft	33,0cm; 13"	
168-380-23	YEOMAN biopsy forceps; straight; toothed; rotating shaft	23,0cm; 9,2"	
168-380-33	YEOMAN biopsy forceps; straight; toothed; rotating shaft	33,0cm; 13"	
168-380-41/A	YEOMAN biopsy forceps, insert only; straight; rotating shaft; ring handle	41,0cm; 16,2"	
168-385-23	TURREL biopsy forceps; curved; toothed; rotating shaft	23,0cm; 9,2"	
168-385-23/A	TURREL biopsy forceps, insert only; curved; rotating shaft, with teeth	23,0cm; 9,2"	
168-385-33	TURREL biopsy forceps; curved; toothed; rotating shaft	33,0cm; 13"	
168-385-33/A	TURREL biopsy forceps, insert only; curved, rotating shaft, with teeth	33,0cm; 13"	
168-385-41/A	TURREL biopsy forceps, insert only; curved; rotating shaft, with teeth	41,0cm; 16,2"	
168-410-00	MC GIVNEY haemorrhoidal ligator; with loading attachment		
168-413-00	haemorrhoidal ligator 14cm working length complete with charging conus 11 and 16mm aspiration tip, 1 pack of rings / 100pcs		
168-482-09	rectal snare, isolated; protection only		
168-482-30	rectal snare, isolated; bayonett	30,0cm; 12"	
168-482-40	rectal snare, isolated; bayonett	40,0cm; 15,8"	
168-490-00	o-rings for haemorrhoidal ligators; material contains latex; please use within max. 12 months		

Alphabetisches Verzeichnis

A

ALAN PARKS, Analspreizer	168.3
ALAN PARKS, Analspreizer, Wechselvalve	168.3
ALLEN, Darm- und Gewebefasszange.....	160.3
ALLIS ATRAUMA, Darm- und Gewebefasszange	164.12
ALLIS, Darm- und Gewebefasszange	160.2, 160.3
ALLIS-ADAIR, Darm- und Gewebefasszange	160.2
ALLIS-BABY, Darm- und Gewebefasszange.....	160.2
Analspreizer, ALAN PARKS	168.3
Analspreizer, Wechselvalve, ALAN PARKS	168.3
Anoskop, IVES-FANSLER.....	168.4

B

BABCOCK ATRAUMA, Darm- und Gewebefasszange	164.12
BABCOCK, Darm- und Gewebefasszange	160.2, 160.5
BENSON, Pylorusspreizer	160.10
Biopsiezange, TURREL	168.5
Biopsiezange, YEOMAN.....	168.5
BOYS-ALLIS, Darm- und Gewebefasszange.....	160.3
BRUNNER ATRAUMA, Darmklemme.....	164.15
BRUNNER, Darmklemme.....	160.6

C

CZERNY, Mastdarmspekula.....	168.1
------------------------------	-------

D

Darm- und Gewebefasszange, ALLEN.....	160.3
Darm- und Gewebefasszange, ALLIS	160.2, 160.3
Darm- und Gewebefasszange, ALLIS ATRAUMA	164.12
Darm- und Gewebefasszange, ALLIS-ADAIR	160.2
Darm- und Gewebefasszange, ALLIS-BABY	160.2
Darm- und Gewebefasszange, BABCOCK	160.2, 160.5
Darm- und Gewebefasszange, BABCOCK ATRAUMA	164.12
Darm- und Gewebefasszange, BOYS-ALLIS.....	160.3
Darm- und Gewebefasszange, DUVAL	160.4
Darm- und Gewebefasszange, JUDD-ALLIS.....	160.3
Darm- und Gewebefasszange, LOCKWOOD.....	160.5
Darm- und Gewebefasszange, THOMS-ALLIS.....	160.4
Darm- und Gewebefasszange, WILLIAMS.....	160.4
Darm-Anastomosenklemme, DE MARTEL-WOLFSON.....	160.9
Darm-Anastomosenklemme, STONE-WATT	160.10
Darmklemme, BRUNNER.....	160.6
Darmklemme, BRUNNER ATRAUMA.....	164.15
Darmklemme, DOYEN.....	160.6
Darmklemme, DOYEN ATRAUMA.....	164.13
Darmklemme, DOYEN-BABY.....	160.6
Darmklemme, KOCHER.....	160.7
Darmklemme, KOCHER ATRAUMA	164.14
Darmklemme, KOCHER-BABY ATRAUMA	164.15
Darmklemme, MAYO-ROBSON	160.7
Darmklemme, MAYO-ROBSON ATRAUMA	164.14
Darmklemme, SCUDDER ATRAUMA	164.16
Darmquetschklemme, PAYR.....	160.8
Darmquetschklemme, PAYR-BABY	160.8

Darm- und Gewebefasszange, DUVAL	160.5
DE MARTEL-WOLFSON, Darm-Anastomosenklemme.....	160.9
DE MARTEL-WOLFSON, Klemmenhalter	160.9
DE MARTEL-WOLFSON, Klemmschließzange	160.9
DOYEN ATRAUMA, Darmklemme.....	164.13
DOYEN, Darmklemme.....	160.6
DOYEN-BABY, Darmklemme	160.6
DUVAL, Darm- und Gewebefasszange	160.4, 160.5

F

FEHLAND ATRAUMA, Rektumklemme	164.17
-------------------------------------	--------

H

Halter, Klemmen-, DE MARTEL-WOLFSON.....	160.9
Hämorrhoiden- Fasszange, MC GIVNEY	168.7
Hämorrhoiden- Ligator, RUDD	168.6
HAYES ATRAUMA, Rektum-Anastomosenklemme	164.18

I

IVES-FANSLER, Anoskop.....	168.4
----------------------------	-------

J

JUDD-ALLIS, Darm- und Gewebefasszange	160.3
---	-------

K

Kaltlichtklammer, Proktoskope.....	168.3
KELLY, Sphinkteroskop	168.4
Klemme, Darm-, BRUNNER.....	160.6
Klemme, Darm-, BRUNNER ATRAUMA	164.15
Klemme, Darm-, DOYEN.....	160.6
Klemme, Darm-, DOYEN ATRAUMA.....	164.13
Klemme, Darm-, DOYEN-BABY.....	160.6
Klemme, Darm-, KOCHER	160.7
Klemme, Darm-, KOCHER ATRAUMA	164.14
Klemme, Darm-, KOCHER-BABY ATRAUMA	164.15
Klemme, Darm-, MAYO-ROBSON	160.7
Klemme, Darm-, MAYO-ROBSON ATRAUMA	164.14
Klemme, Darm-, SCUDDER ATRAUMA	164.16
Klemme, Darm-Anastomosen-, DE MARTEL-WOLFSON....	160.9
Klemme, Darm-Anastomosen-, STONE-WATT	160.10
Klemme, Darmquetsch-, PAYR	160.8
Klemme, Darmquetsch-, PAYR-BABY	160.8
Klemme, Magen- und Darm-Zwillings-, LANE.....	160.11
Klemme, Rektum-, FEHLAND ATRAUMA	164.17
Klemme, Rektum-, RESANO ATRAUMA.....	164.17
Klemme, Rektum-Anastomosen-, HAYES ATRAUMA.....	164.18
Klemme, Schließ-, STONE-WATT	160.10
Klemmenhalter, DE MARTEL-WOLFSON.....	160.9
Klemmschließzange, DE MARTEL-WOLFSON	160.9
KOCHER ATRAUMA, Darmklemme	164.14
KOCHER, Darmklemme	160.7
KOCHER-BABY ATRAUMA, Darmklemme	164.15



Alphabetisches Verzeichnis

L

Ladekonus für Hämorrhoiden- Ligator, RUDD	168.6
LANE, Magen- und Darm-Zwillingsklemme	160.11
Ligaterringe für Hämorrhoiden- Ligator	168.6
LOCKWOOD, Darm- und Gewebefasszange	160.5

M

Magen- und Darm-Zwillingsklemme, LANE	160.11
Mastdarmspekula, CZERNY	168.1
Mastdarmspekula, PRATT	168.2
Mastdarmspekula, SIMS	168.2
MAYO-ROBSON ATRAUMA, Darmklemme	164.14
MAYO-ROBSON, Darmklemme	160.7
MC GIVNEY, Hämorrhoiden- Fasszange	168.7

P

PAYR, Darmquetschklemme	160.8
PAYR-BABY, Darmquetschklemme	160.8
PRATT, Mastdarmspekula	168.2
Pylorusspreizer, BENSON	160.10

R

Rektum-Anastomosenklemme, HAYES ATRAUMA	164.18
Rektumklemme, FEHLAND ATRAUMA	164.17
Rektumklemme, RESANO ATRAUMA	164.17
RESANO ATRAUMA, Rektumklemme	164.17
RUDD, Hämorrhoiden- Ligator	168.6
RUDD, Ladekonus für Hämorrhoiden- Ligator	168.6

S

Schließklemme, STONE-WATT	160.10
SCUDDER ATRAUMA, Darmklemme	164.16
SIMS, Mastdarmspekula	168.2
Spekula, Mastdarm, CZERNY	168.1
Spekula, Mastdarm, PRATT	168.2
Spekula, Mastdarm, SIMS	168.2
Sphinkterskop, KELLY	168.4
Spreizer, Pylorus-, BENSON	160.10
STONE-WATT, Darm-Anastomosenklemme	160.10
STONE-WATT, Schließklemme	160.10

T

THOMS-ALLIS, Darm- und Gewebefasszange	160.4
TURREL, Biopsiezange	168.5

W

WILLIAMS, Darm- und Gewebefasszange	160.4
---	-------

Y

YEOMAN, Biopsiezange	168.5
----------------------------	-------

Z

Zange, Darm- und Gewebefass-, ALLEN	160.3
Zange, Darm- und Gewebefass-, ALLIS	160.2, 160.3

Zange, Darm- und Gewebefass-, ALLIS ATRAUMA	164.12
Zange, Darm- und Gewebefass-, ALLIS-ADAIR	160.2
Zange, Darm- und Gewebefass-, ALLIS-BABY	160.2
Zange, Darm- und Gewebefass-, BABCOCK	160.2, 160.5
Zange, Darm- und Gewebefass-, BABCOCK ATRAUMA ..	164.12
Zange, Darm- und Gewebefass-, BOYS-ALLIS	160.3
Zange, Darm- und Gewebefass-, DUVAL	160.4, 160.5
Zange, Darm- und Gewebefass-, JUDD-ALLIS	160.3
Zange, Darm- und Gewebefass-, LOCKWOOD	160.5
Zange, Darm- und Gewebefass-, THOMS-ALLIS	160.4
Zange, Darm- und Gewebefass-, WILLIAMS	160.4
Zange, Klemmschließ-, DE MARTEL-WOLFSON	160.9

Index, alphabetical

A

ALAN PARKS, rectal spreader 168.3
 ALAN PARKS, rectal spreader, blade 168.3
 ALLEN, intestinal and tissue grasping forceps 160.3
 ALLIS ATRAUMA, intestinal and tissue grasping forceps .. 164.12
 ALLIS, intestinal and tissue grasping forceps 160.2, 160.3
 ALLIS-ADAIR, intestinal and tissue grasping forceps 160.2
 ALLIS-BABY, intestinal and tissue grasping forceps 160.2
 anoscope, IVES-FANSLER 168.4

B

BABCOCK ATRAUMA, intestinal and tissue grasping forceps 164.12
 BABCOCK, intestinal and tissue grasping forceps ... 160.2, 160.5
 BENSON, pylorus spreader 160.10
 biopsy forceps, TURREL 168.5
 biopsy forceps, YEOMAN 168.5
 BOYS-ALLIS, intestinal and tissue grasping forceps 160.3
 BRUNNER ATRAUMA, intestinal clamp 164.15
 BRUNNER, intestinal clamp 160.6

C

clamp holder, DE MARTEL-WOLFSON 160.9
 clamp, intestinal anastomosis, DE MARTEL-WOLFSON 160.9
 clamp, intestinal anastomosis, STONE-WATT 160.10
 clamp, intestinal and pylorus, PAYR 160.8
 clamp, intestinal and pylorus, PAYR-BABY 160.8
 clamp, intestinal, BRUNNER 160.6
 clamp, intestinal, BRUNNER ATRAUMA 164.15
 clamp, intestinal, DOYEN 160.6
 clamp, intestinal, DOYEN ATRAUMA 164.13
 clamp, intestinal, DOYEN-BABY 160.6
 clamp, intestinal, KOCHER 160.7
 clamp, intestinal, KOCHER ATRAUMA 164.14
 clamp, intestinal, KOCHER-BABY ATRAUMA 164.15
 clamp, intestinal, MAYO-ROBSON 160.7
 clamp, intestinal, MAYO-ROBSON ATRAUMA 164.14
 clamp, intestinal, SCUDDER ATRAUMA 164.16
 clamp, sigmoid anastomosis, FEHLAND ATRAUMA 164.17
 clamp, sigmoid anastomosis, HAYES ATRAUMA 164.18
 clamp, sigmoid anastomosis, RESANO ATRAUMA 164.17
 clamp, stomach and intestinal anastomosis twin, LANE ... 160.11
 closing forceps, DE MARTEL-WOLFSON 160.9
 closing forceps, STONE-WATT 160.10
 cold light carrier, for rectal spreaders 168.3
 CZERNY, rectal specula 168.1

D

DE MARTEL-WOLFSON, clamp holder 160.9
 DE MARTEL-WOLFSON, closing forceps 160.9
 DE MARTEL-WOLFSON, intestinal anastomosis clamp 160.9
 DOYEN ATRAUMA, intestinal clamp 164.13
 DOYEN, intestinal clamp 160.6
 DOYEN-BABY, intestinal clamp 160.6

DUVAL, intestinal and tissue grasping forceps 160.4, 160.5

F

FEHLAND ATRAUMA, sigmoid anastomosis clamp 164.17
 forceps, closing, DE MARTEL-WOLFSON 160.9
 forceps, closing, STONE-WATT 160.10
 forceps, intestinal and tissue grasping, ALLEN 160.3
 forceps, intestinal and tissue grasping, ALLIS 160.2, 160.3
 forceps, intestinal and tissue grasping, ALLIS ATRAUMA 164.12
 forceps, intestinal and tissue grasping, ALLIS-ADAIR 160.2
 forceps, intestinal and tissue grasping, ALLIS-BABY 160.2
 forceps, intestinal and tissue grasping, BABCOCK .. 160.2, 160.5
 forceps, intestinal and tissue grasping, BABCOCK-ATRAUMA 164.12
 forceps, intestinal and tissue grasping, BOYS-ALLIS 160.3
 forceps, intestinal and tissue grasping, DUVAL 160.4, 160.5
 forceps, intestinal and tissue grasping, JUDD-ALLIS 160.3
 forceps, intestinal and tissue grasping, LOCKWOOD 160.5
 forceps, intestinal and tissue grasping, THOMS-ALLIS 160.4
 forceps, intestinal and tissue grasping, WILLIAMS 160.4
 forceps, intestinal and tissue grasping, ALLIS 160.3

H

HAYES ATRAUMA, sigmoid anastomosis clamp 164.18
 hemorrhoidal ligator, RUDD 168.6
 hemorrhoidal ligatur forceps, MC GIVNEY 168.7

I

intestinal anastomosis clamp, DE MARTEL-WOLFSON 160.9
 intestinal anastomosis clamp, STONE-WATT 160.10
 intestinal and pylorus clamp, PAYR 160.8
 intestinal and pylorus clamp, PAYR-BABY 160.8
 intestinal and tissue grasping forceps, ALLEN 160.3
 intestinal and tissue grasping forceps, ALLIS 160.2, 160.3
 intestinal and tissue grasping forceps, ALLIS ATRAUMA .. 164.12
 intestinal and tissue grasping forceps, ALLIS-ADAIR 160.2
 intestinal and tissue grasping forceps, ALLIS-BABY 160.2
 intestinal and tissue grasping forceps, BABCOCK ... 160.2, 160.5
 intestinal and tissue grasping forceps, BABCOCK ATRAUMA 164.12
 intestinal and tissue grasping forceps, BOYS-ALLIS 160.3
 intestinal and tissue grasping forceps, DUVAL 160.4, 160.5
 intestinal and tissue grasping forceps, JUDD-ALLIS 160.3
 intestinal and tissue grasping forceps, LOCKWOOD 160.5
 intestinal and tissue grasping forceps, THOMS-ALLIS 160.4
 intestinal and tissue grasping forceps, WILLIAMS 160.4
 intestinal clamp, BRUNNER 160.6
 intestinal clamp, BRUNNER ATRAUMA 164.15
 intestinal clamp, DOYEN 160.6
 intestinal clamp, DOYEN ATRAUMA 164.13
 intestinal clamp, DOYEN-BABY 160.6
 intestinal clamp, KOCHER 160.7
 intestinal clamp, KOCHER ATRAUMA 164.14
 intestinal clamp, KOCHER-BABY ATRAUMA 164.15



Index, alphabetical

intestinal clamp, MAYO-ROBSON 160.7
 intestinal clamp, MAYO-ROBSON ATRAUMA 164.14
 intestinal clamp, SCUDDER ATRAUMA 164.16
 IVES-FANSLER, anoscope 168.4

J
 JUDD-ALLIS, intestinal and tissue grasping forceps 160.3

K
 KELLY, sphincteroscope 168.4
 KOCHER ATRAUMA, intestinal clamp 164.14
 KOCHER, intestinal clamp 160.7
 KOCHER-BABY ATRAUMA, intestinal clamp 164.15

L
 LANE, stomach and intestinal anastomosis twin clamp 160.11
 loading cone for hemorrhoidal ligator, RUDD 168.6
 LOCKWOOD, intestinal and tissue grasping forceps 160.5

M
 MAYO-ROBSON ATRAUMA, intestinal clamp 164.14
 MAYO-ROBSON, intestinal clamp 160.7
 MC GIVNEY, hemorrhoidal ligatur forceps 168.7

P
 PAYR, intestinal and pylorus clamp 160.8
 PAYR-BABY, intestinal and pylorus clamp 160.8
 PRATT, rectal specula 168.2
 pylorus spreader, BENSON 160.10

R
 rectal specula, CZERNY 168.1
 rectal specula, PRATT 168.2
 rectal specula, SIMS 168.2
 rectal spreader, ALAN PARKS 168.3
 rectal spreader, blade, ALAN PARKS 168.3
 RESANO ATRAUMA, sigmoid anastomosis clamp 164.17
 rubber rings for hemorrhoidal ligator 168.6
 RUDD, hemorrhoidal ligator 168.6
 RUDD, loading cone for hemorrhoidal ligator 168.6

S
 SCUDDER ATRAUMA, intestinal clamp 164.16
 sigmoid anastomosis clamp, FEHLAND ATRAUMA 164.17
 sigmoid anastomosis clamp, HAYES ATRAUMA 164.18
 sigmoid anastomosis clamp, RESANO ATRAUMA 164.17
 SIMS, rectal specula 168.2
 sphincteroscope, KELLY 168.4
 spreader, pylorus, BENSON 160.10
 stomach and intestinal anastomosis twin clamp, LANE 160.11
 STONE-WATT, closing forceps 160.10
 STONE-WATT, intestinal anastomosis clamp 160.10

T
 THOMS-ALLIS, intestinal and tissue grasping forceps 160.4
 TURREL, biopsy forceps 168.5

W
 WILLIAMS, intestinal and tissue grasping forceps 160.4

Y
 YEOMAN, biopsy forceps 168.5

Indice, alfabético

A

ALAN PARKS, separadores rectales	168.3
ALAN PARKS, separadores rectales, valvas	168.3
ALLEN, pinza para intestino y tejido	160.3
ALLIS ATRAUMA, pinza para intestino y tejido	164.12
ALLIS, pinza para intestino y tejido	160.2, 160.3
ALLIS-ADAIR, pinza para intestino y tejido	160.2
ALLIS-BABY, pinza para intestino y tejido	160.2
anillos de goma para ligador para hemorroides	168.6
anoscopio, IVES-FANSLER	168.4

B

BABCOCK ATRAUMA, pinza para intestino y tejido	164.12
BABCOCK, pinza para intestino y tejido	160.2, 160.5
BENSON, separador para píloro	160.10
BOYS-ALLIS, pinza para intestino y tejido	160.3
BRUNNER ATRAUMA, pinza intestinal	164.15
BRUNNER, pinza intestinal	160.6

C

clamp para anastomosis intestinal, DE MARTEL-WOLFSON	160.9
clamp para anastomosis intestinal, STONE-WATT	160.10
cono de cargo para ligador para hemorroides, RUDD	168.6
CZERNY, espéculos rectales	168.1

D

DE MARTEL-WOLFSON, clamp para anastomosis intestinal	160.9
DE MARTEL-WOLFSON, pinza para cerrar grapas	160.9
DE MARTEL-WOLFSON, porta-clamp	160.9
DOYEN ATRAUMA, pinza intestinal	164.13
DOYEN, pinza intestinal	160.6
DOYEN-BABY, pinza intestinal	160.6
DUVAL, pinza para intestino y tejido	160.4, 160.5

E

esfínteroscopio, KELLY	168.4
espéculos rectales, CZERNY	168.1
espéculos rectales, PRATT	168.2
espéculos rectales, SIMS	168.2

F

FEHLAND ATRAUMA, pinza para anastomosis rectal	164.17
--	--------

H

HAYES ATRAUMA, pinza para anastomosis rectal	164.18
--	--------

I

IVES-FANSLER, anoscopio	168.4
-------------------------------	-------

J

JUDD-ALLIS, pinza para intestino y tejido	160.3
---	-------

K

KELLY, esfínteroscopio	168.4
KOCHER ATRAUMA, pinza intestinal	164.14
KOCHER, pinza intestinal	160.7
KOCHER-BABY ATRAUMA, pinza intestinal	164.15

L

LANE, pinza gastro-intestinal gemales	160.11
ligador para hemorroides, MC GIVNEY	168.7
ligador para hemorroides, RUDD	168.6
LOCKWOOD, pinza para intestino y tejido	160.5

M

MAYO-ROBSON ATRAUMA, pinza intestinal	164.14
MAYO-ROBSON, pinza intestinal	160.7
MC GIVNEY, ligador para hemorroides	168.7

P

PAYR, pinza intestinal para píloro	160.8
PAYR-BABY, pinza intestinal para píloro	160.8
pinza gastro-intestinal gemales, LANE	160.11
pinza intestinal para píloro, PAYR	160.8
pinza intestinal para píloro, PAYR-BABY	160.8
pinza intestinal, BRUNNER	160.6
pinza intestinal, BRUNNER ATRAUMA	164.15
pinza intestinal, DOYEN	160.6
pinza intestinal, DOYEN ATRAUMA	164.13
pinza intestinal, DOYEN-BABY	160.6
pinza intestinal, KOCHER	160.7
pinza intestinal, KOCHER ATRAUMA	164.14
pinza intestinal, KOCHER-BABY ATRAUMA	164.15
pinza intestinal, MAYO-ROBSON	160.7
pinza intestinal, MAYO-ROBSON ATRAUMA	164.14
pinza intestinal, SCUDDER ATRAUMA	164.16
pinza para anastomosis rectal, FEHLAND ATRAUMA	164.17
pinza para anastomosis rectal, HAYES ATRAUMA	164.18
pinza para anastomosis rectal, RESANO ATRAUMA	164.17
pinza para biopsia, TURREL	168.5
pinza para biopsia, YEOMAN	168.5
pinza para cerrar clamp, STONE-WATT	160.10
pinza para cerrar grapas, DE MARTEL-WOLFSON	160.9
pinza para intestino y tejido, ALLEN	160.3
pinza para intestino y tejido, ALLIS	160.2, 160.3
pinza para intestino y tejido, ALLIS ATRAUMA	164.12
pinza para intestino y tejido, ALLIS-ADAIR	160.2
pinza para intestino y tejido, ALLIS-BABY	160.2
pinza para intestino y tejido, BABCOCK	160.2, 160.5
pinza para intestino y tejido, BABCOCK ATRAUMA	164.12
pinza para intestino y tejido, BOYS-ALLIS	160.3
pinza para intestino y tejido, DUVAL	160.4, 160.5
pinza para intestino y tejido, JUDD-ALLIS	160.3
pinza para intestino y tejido, LOCKWOOD	160.5
pinza para intestino y tejido, THOMS-ALLIS	160.4
pinza para intestino y tejido, WILLIAMS	160.4



Indice, alfabético

porta-clamp, DE MARTEL-WOLFSON.....	160.9
portador de luz fría para separadores rectales	168.3
PRATT, espéculos rectales	168.2

R

RESANO ATRAUMA, pinza para anastomosis rectal.....	164.17
RUDD, cono de cargo para ligador para hemorroides.....	168.6
RUDD, ligador para hemorroides	168.6

S

SCUDDER ATRAUMA, pinza intestinal	164.16
separador para píloro, BENSON	160.10
separadores rectales, ALAN PARKS	168.3
separadores rectales, valvas, ALAN PARKS	168.3
SIMS, espéculos rectales.....	168.2
STONE-WATT, clamp para anastomosis intestinal	160.10
STONE-WATT, pinza para cerrar clamp	160.10

T

THOMS-ALLIS, pinza para intestino y tejido.....	160.4
TURREL, pinza para biopsia	168.5

W

WILLIAMS, pinza para intestino y tejido	160.4
---	-------

Y

YEOMAN, pinza para biopsia.....	168.5
---------------------------------	-------