

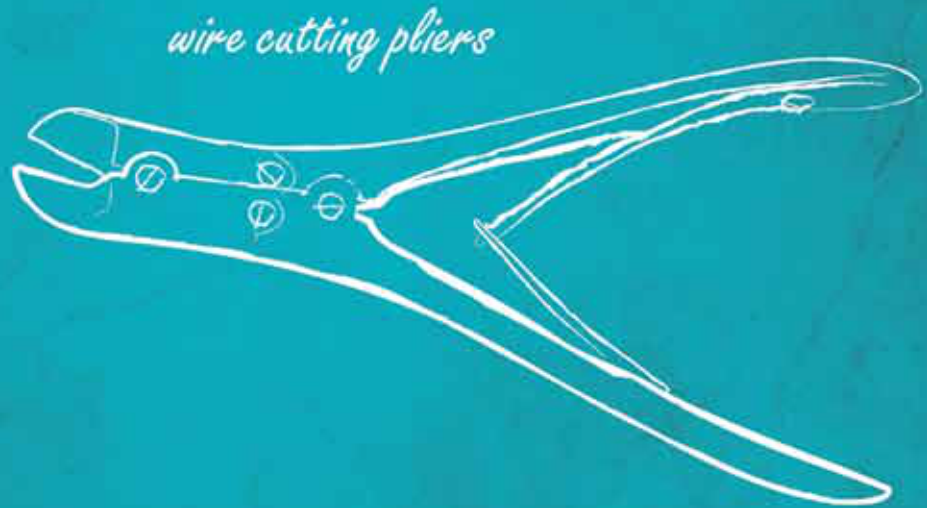

hand drills



wire cutting pliers

Knochenchirurgie
Bone Surgery

190

Gipsmesser; Gipssäge
 Plaster Knives; plaster saw
 Cuchillos para yeso; sierra para yeso



Art.Nr.	Beschreibung Description	Size	Spez.
190-130-20	HOPKINS mit Holzheft with wooden handle con mango de madera	20,0cm; 7 7/8"	



190-138-18	ESMARCH	18,0cm; 7 1/8"	
------------	---------	----------------	--



190-140-18	REINER	18,0cm; 7 1/8"	
------------	--------	----------------	--



190-160-14	ENGEL	15,0cm; 5 7/8"	
------------	-------	----------------	--



190-162-18	BERGMANN	18,0cm; 7 1/8"	
------------	----------	----------------	--



Gipsspreizer; Gipsabreißzangen
 Plaster Spreaders; Plaster Breakers
 Separadores para yeso; Pinzas para romper yeso

Art.Nr.	Beschreibung Description	Size	Spez.
190-200-28	HENNING	28,0cm; 11"	

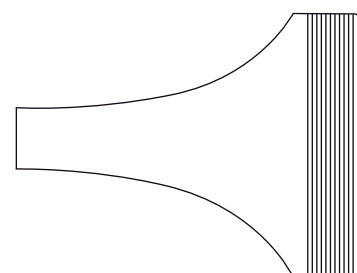

190-220-23	MODELL USA	23,0cm; 9"	
------------	------------	------------	--



WOLFF



190-204-18	18,0cm; 7"		
------------	------------	--	--



190-204-24	24,0cm; 9 4/8"		
------------	----------------	--	--

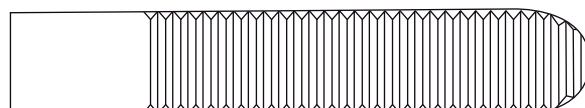

Gipsscheren
Plaster Shears
Tijeras para yeso

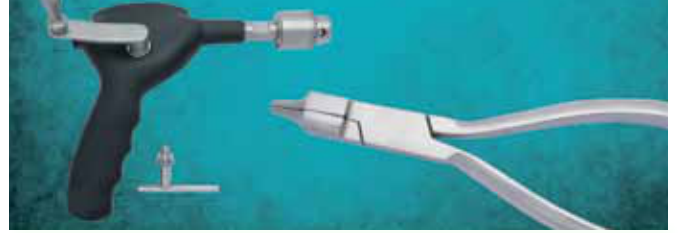

Art.Nr.	Beschreibung Description	Size	Spez.
---------	----------------------------	------	-------

STILLE

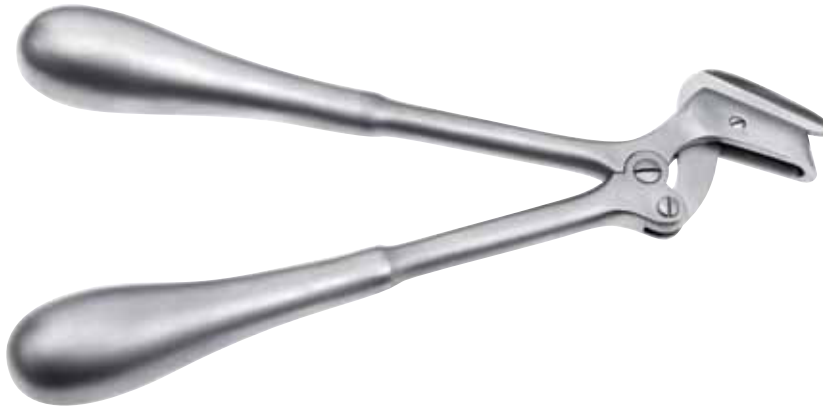

190-208-23	23,0cm; 9"		
190-208-26	26,0cm; 10 5/8"		
190-208-37	37,0cm; 15"		

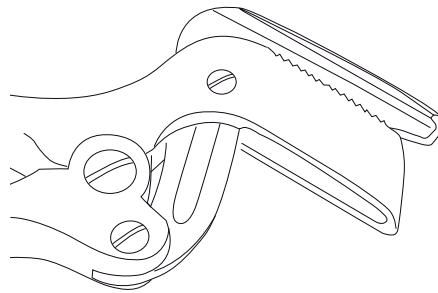

Amputationssägen
 Amputation Saws
 Sierras de amputación

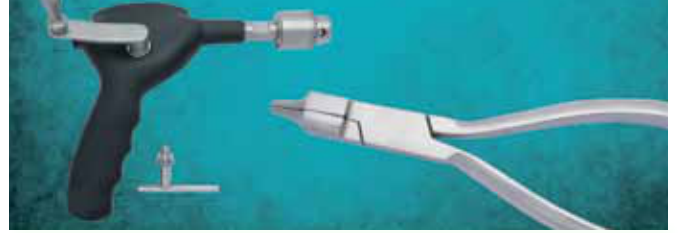

Art.Nr.	Beschreibung Description	Size	Spez.
190-210-35	CHARRIÈRE mit 2 Sägeblätter 12 mm und 18 mm with two saw blades 12 mm and 18 mm con 2 hojas 12 mm y 18 mm	35,0cm; 13 6/8"	SET



Ersatzsägeblatt
 saw blade
 hojas de recambio



190-211-12	12 mm
190-211-15	15 mm
190-211-18	18 mm

190

Amputationssägen
 Amputation Saws
 Sierras de amputación

Art.Nr.	Beschreibung Description	Size	Spez.
190-212-39	BIER mit 3 Sägeblätter 4 mm, 6 mm und 8 mm with three saw blades 4 mm, 6 mm and 8 mm con 3 hojas 4 mm, 6 mm y 8 mm	40,5cm; 16"	SET



Ersatzsägeblatt
 saw blade
 hojas de recambio



- 190-213-04 4 mm
- 190-213-06 6 mm
- 190-213-08 8 mm

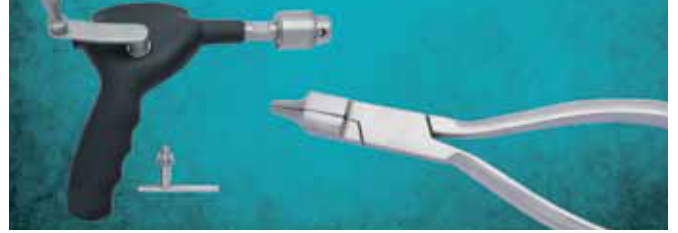

Art.Nr.	Beschreibung Description	Size	Spez.
190-218-23	LANGENBECK	24,0cm; 9 4/8"	



CHARRIÈRE



190-220-27 27,0cm; 10 3/8"

190-220-30 30,0cm; 11 3/4"

190-220-34 34,0cm; 13 1/3"

Amputationssägen; Amputationsschild; Bohrerführungsinstrument
Amputation Saws; Amputation Retractor; Drill Guide
Sierras de amputación; retractor para amputación; Pinza-guía

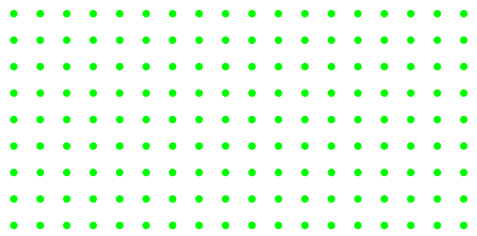

Art.Nr.	Beschreibung Description	Size	Spez.
190-225-31	SATTERLEE	29,0cm; 11 3/8"	



190-225-20	Ersatzsägeblatt saw blade hojas de recambio
------------	---

190-240-00	PERCY auseinandernehmbar detachable desmontable
------------	---



190-242-15	ADSON	15,0cm; 5 7/8"
------------	-------	----------------

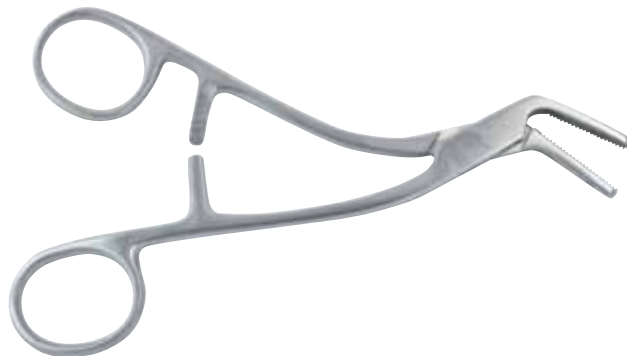

Reibahlen
Reamer
Escariadores

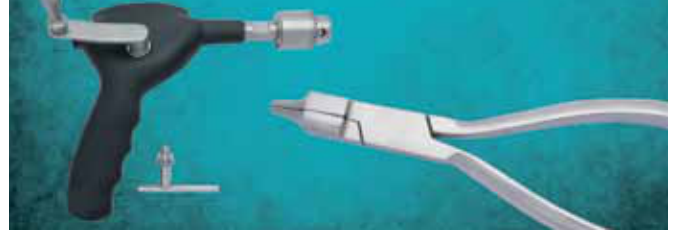

Art.Nr.	Beschreibung Description	Size	Spez.
190-244-13		14,0cm; 5 1/8"	



190-245-14	eine Seite konkav one side concave un lado cóncavo	14,0cm; 5 1/8"	
------------	--	----------------	--



PERTHES



190-246-18	18,0cm; 7 1/8"		
------------	----------------	--	--

190-246-21	21,5cm; 8 4/8"		
------------	----------------	--	--

Art.Nr.	Beschreibung Description	Size	Spez.
190-260-00	STILLE mit 9 Bohrern und Fräser Artikel 190-261-25 - 190-263-16 with nine twist drills and burrs ref. 190-261-25 - 190-263-16 con nueve brocas y taladros ref. 190-261-25 - 190-263-16		SET



Spiralbohrer für Handbohrapparat
Twist drill for hand drill
Broca espiral de perforadores de mano

190-261-10	Ø 1,0 mm		190-261-30	Ø 3,0 mm	
190-261-15	Ø 1,5 mm		190-261-35	Ø 3,5 mm	
190-261-20	Ø 2,0 mm		190-261-40	Ø 4,0 mm	
190-261-25	Ø 2,5 mm				

Fräser für Handbohrapparat
Burrs for hand drill
Taladros de perforadores de mano

190-262-10	Ø 10,0 mm				
190-263-05	Ø 5,0 mm		190-263-12	Ø 12,0 mm	
190-263-08	Ø 8,0 mm		190-263-16	Ø 16,0 mm	

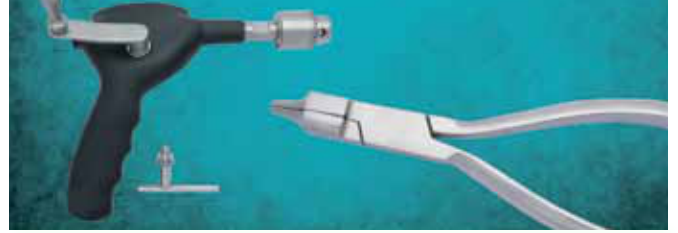

Art.Nr.	Beschreibung Description	Size	Spez.
190-270-00	HUDSON mit Fräsern Fig. 1-4 und Verlängerungsstück with burrs no. 1-4 and extension piece con fresas no. 1-4 y pieza de extensión		SET



190-271-00	Verlängerungsstück extention piece pieza de prolongación
------------	--



Kegelfräser
Conical Burr
Fresa cónica

190-271-10	Fig. 1	Ø 10,0 mm	
190-271-14	Fig. 2	Ø 14,0 mm	
190-271-16	Fig. 3	Ø 16,0 mm	
190-271-22	Fig. 4	Ø 22,0 mm	

Handbohrapparate
Hand Drills
Perforadores de mano

Art.Nr.	Beschreibung Description	Size	Spez.
190-272-13	CUSHING Flachbohrer flat trephine taladro plano	Ø 13,0 mm	
190-273-24	ADSON Spiralbohrer twist drill broca espira	Ø 2,0 mm	
190-274-13	MC KENZIE Fräser burr taladros	Ø 13,0 mm	
190-274-16	ERRICO Fräser burr taladros	Ø 16,0 mm	
190-280-04	MOORE mit 3 Bohrer with 3 drills con 3 brocas	27,5cm; 10 7/8"	SET



Spiralbohrer; Flachbohrer
 Twist drill; Flat trephine
 Broca espiral; Taladro plano



Art.Nr.	Beschreibung Description	Size	Spez.
---------	----------------------------	------	-------

BORCHARDT langes Arbeitsteil; Schaft 5 mm
 long working end; shaft 5 mm
 punta larga; vástago 5 mm



190-282-20	Ø 2,0 mm	190-282-40	Ø 4,0 mm
190-282-25	Ø 2,5 mm	190-282-50	Ø 5,0 mm
190-282-30	Ø 3,0 mm	190-282-60	Ø 6,0 mm
190-282-32	Ø 3,2 mm	190-282-70	Ø 7,0 mm
190-282-35	Ø 3,5 mm		

BORCHARDT kurzes Arbeitsteil; Schaft 5 mm
 short working end; shaft 5 mm
 punta corto; vástago 5 mm



190-283-10	Ø 1,0 mm	190-283-28	Ø 2,8 mm
190-283-12	Ø 1,2 mm	190-283-30	Ø 3,0 mm
190-283-15	Ø 1,5 mm	190-283-32	Ø 3,2 mm
190-283-18	Ø 1,8 mm	190-283-35	Ø 3,5 mm
190-283-20	Ø 2,0 mm	190-283-40	Ø 4,0 mm
190-283-22	Ø 2,2 mm	190-283-50	Ø 5,0 mm
190-283-25	Ø 2,5 mm		

BORCHARDT mit Öhr; Schaft 5 mm
 with eye; shaft 5 mm
 con agujero; vástago 5 mm



190-284-18	Ø 1,8 mm	190-284-30	Ø 3,0 mm
190-284-20	Ø 2,0 mm	190-284-35	Ø 3,5 mm
190-284-22	Ø 2,2 mm	190-284-40	Ø 4,0 mm
190-284-25	Ø 2,5 mm	190-284-50	Ø 5,0 mm

Kugelfräser; Ovalfräser; Spiralbohrer
 Spherical burr; spherical burr; Twist drill
 Fresa esférica; fresa esférica; Broca espiral

Art.Nr.	Beschreibung Description	Size	Spez.
---------	----------------------------	------	-------

Borchardt-Schaft; 5 mm
 Borchardt shaft; 5 mm
 vástago Borchardt 5mm



190-286-30 Ø 3,0 mm

190-286-40 Ø 4,0 mm

konisch; feine Teilung; 5mm Borchardt-Schaft
 conical; fine spacing; 5mm Borchardt shaft
 cónica; paso fino; vástago Borchardt 5mm



190-287-30 Ø 3,0 mm

190-287-50 Ø 5,0 mm

glatter Schaft
 smooth shaft
 vástago liso



190-288-10 Ø 1,0 mm

190-288-15 Ø 1,5 mm

190-288-20 Ø 2,0 mm

190-288-25 Ø 2,5 mm

190-288-28 Ø 2,8 mm

190-288-30 Ø 3,0 mm

190-288-32 Ø 3,2 mm

190-288-35 Ø 3,5 mm

190-288-40 Ø 4,0 mm

190-288-45 Ø 4,5 mm

190-288-50 Ø 5,0 mm

190-288-60 Ø 6,0 mm

Kugelfräser
Spherical burr
Fresa esférica

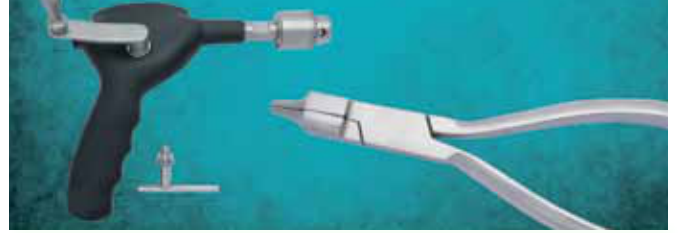

Art.Nr.	Beschreibung Description	Size	Spez.
---------	----------------------------	------	-------

DOYEN langer Borchartt-Schaft
long Borchartt shaft
vástago Borchartt largo



- 190-290-04 Ø 4,0 mm
- 190-290-06 Ø 6,0 mm
- 190-290-08 Ø 8,0 mm
- 190-290-10 Ø 10,0 mm
- 190-290-12 Ø 12,0 mm
- 190-290-14 Ø 14,0 mm
- 190-290-16 Ø 16,0 mm

DOYEN kurzer Borchartt-Schaft
short Borchartt shaft
vástago Borchartt corto



- 190-291-04 Ø 4,0 mm
- 190-291-06 Ø 6,0 mm
- 190-291-08 Ø 8,0 mm
- 190-291-10 Ø 10,0 mm
- 190-291-12 Ø 12,0 mm
- 190-291-14 Ø 14,0 mm
- 190-291-16 Ø 16,0 mm

190

Art.Nr.	Beschreibung Description	Size	Spez.
190-296-00	BUNNELL längsdurchbohrt; mit Dreibackenspannfutter und Schlüssel; Spannweite bis Ø 4 mm longitudinally bored with three-jaw chuck and key; opening up to Ø 4 mm taladrado longitudinalmente con mandril de tres mordazas y llave; abriendo hasta Ø 4 mm		



190-300-00	RALK längsdurchbohrt; mit Dreibackenspannfutter und Schlüssel; Spannweite Ø 0,8 bis 7,0 mm longitudinally bored with three-jaw chuck and key; opening Ø 0,8 up to 7,0 mm taladrado longitudinalmente con mandril de tres mordazas y llave; abriendo Ø 0,8 hasta 7,0 mm		
------------	--	--	--



Bohrhandgriff; Dreibackenspannfutter
 Drill Handles; Three-jaw chuck
 Perforadores de mano; mandril de tres mordazas

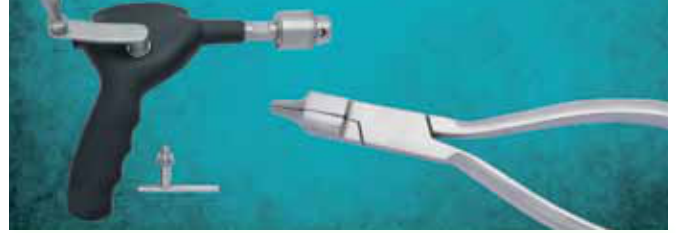

Art.Nr.	Beschreibung Description	Size	Spez.
---------	----------------------------	------	-------

190-303-10	Bohrhandgriff mit Dreibacken-Spannfutter und Schlüssel handle with three-jaw-chuck and key mango con mandril de tres mordazas y llave		
------------	---	--	--





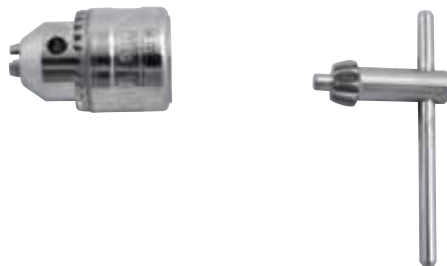



190-312-00	Dreibacken-Spannfutter mit Spannschlüssel three-jaw-chuck with key mandril de tres mordazas y llave		
------------	---	--	--

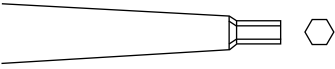

190-312-01	Spannschlüssel key llave		
------------	--------------------------------	--	--



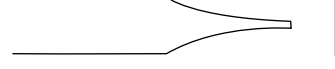









Schraubendreher mit Kunststoffgriff
 Screwdriver with plastic handle
 Destornilladores con mango de plástico





Art.Nr.	Beschreibung Description	Size	Spez.
190-330-25		2,5 mm	
190-331-25		3,5 mm	
190-332-25		6,0 mm	
190-333-25	Phillips 	6,0 mm	

Schraubendreher
Screwdriver
Destornilladores



Art.Nr.	Beschreibung Description	Size	Spez.
190-335-00	durchbohrt; mit Schnellspannfutter with bore and quick-action chuck perforato; con innesto rapido	14,5cm; 5,8"	
			
190-336-01	Schlitz flat tip ranurada	14,0cm; 5,6" 6,0 mm	
			
190-336-02	kreuzschlitz groß phillips attachment punta philips	14,0cm; 5,6" Ø 5,0 mm	
			
190-336-03	kreuzschlitz klein phillips attachment punta philips	14,0cm; 5,6" Ø 4,0 mm	
			
190-336-04	hexagonal hexagonal wrench hexagonal	14,0cm; 5,6" 2,5 mm	
			
190-336-05	hexagonal hexagonal wrench hexagonal	14,0cm; 5,6" 3,5 mm	
			

Knochenheber
 Bone Levers
 Elevadores para hueso

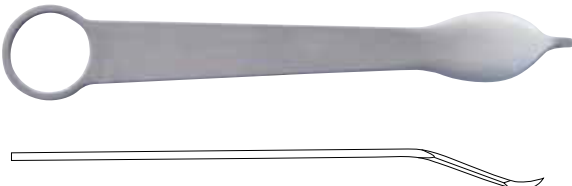
Art.Nr.	Beschreibung Description	Size	Spez.
190-564-64	VERBRUGGE-MÜLLER	25,0cm; 10" 65,0 mm	
			
190-570-07		15,0cm; 5 7/8" 7 mm	
			
190-571-06	MINI-HOHMANN	16,0cm; 6 2/8" 6 mm	
			
190-571-08	MINI-HOHMANN	16,0cm; 6 2/8" 8 mm	
			
190-571-15		16,0cm; 6 2/8" 15 mm	
			
190-571-16		12,0cm; 4 6/8" 15 mm	
			

Knochenheber
 Bone Levers
 Elevadores para hueso



Art.Nr.	Beschreibung Description	Size	Spez.
---------	----------------------------	------	-------

190-572-08	HOHMANN schmale Spitze narrow tip punta estrecha	21,5cm ; 8 4/8" 8 mm	
------------	---	-------------------------	--

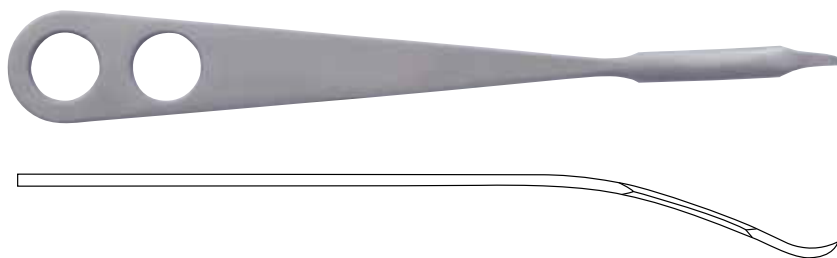

190-572-18	HOHMANN schmale Spitze narrow tip punta estrecha	23,5cm ; 9 2/8" 18 mm	
------------	---	--------------------------	--

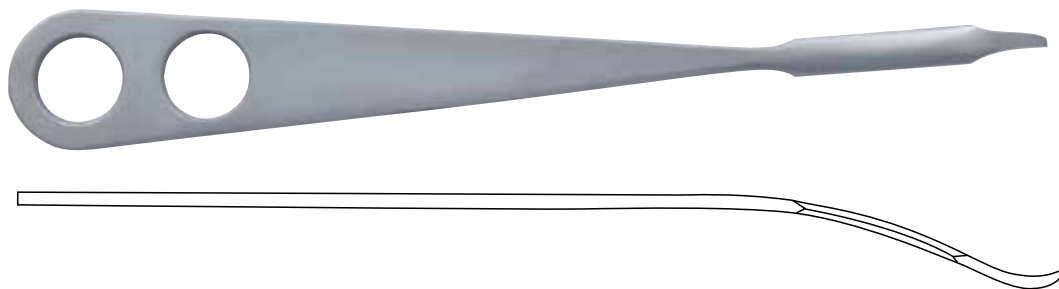

190-572-43	HOHMANN schmale Spitze narrow tip punta estrecha	23,5cm ; 9 2/8" 43 mm	
------------	---	--------------------------	--

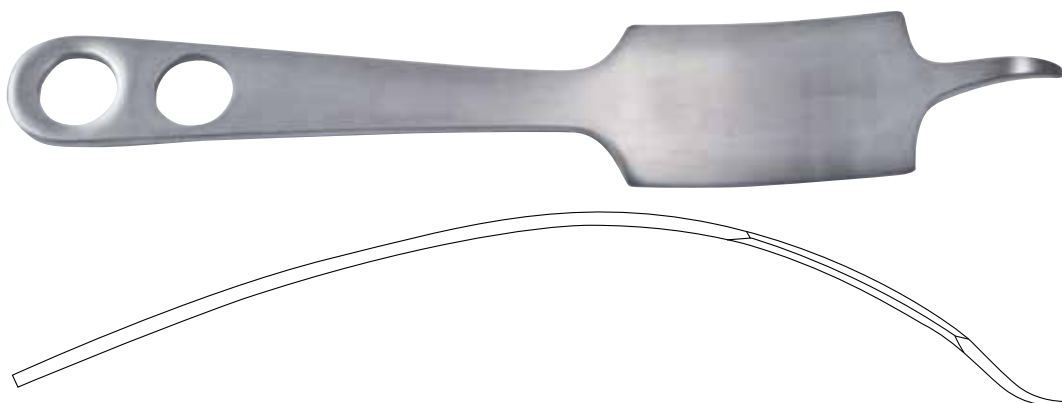

Knochenhebel
 Bone Levers
 Elevadores para hueso

Art.Nr.	Beschreibung Description	Size	Spez.
190-573-22	HOHMANN breite Spitze wide tip punta ancha	25,5cm; 10" 22 mm	

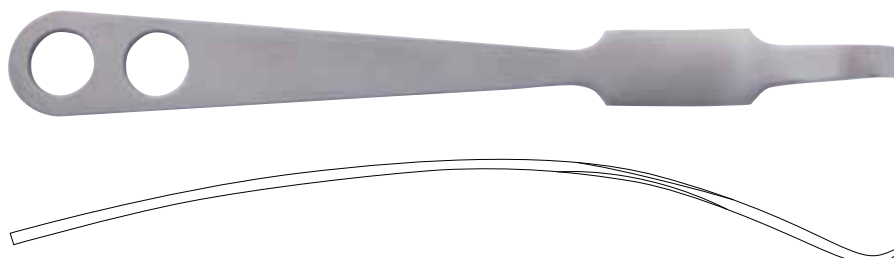

190-573-24	HOHMANN breites, rundes Ende wide, round end punta ancha; redonda	27,5cm; 10 7/8" 24 mm	
------------	---	--------------------------	--



190-573-35	HOHMANN breite Spitze wide tip punta ancha	29,0cm; 11 3/8" 35 mm	
------------	--	--------------------------	--

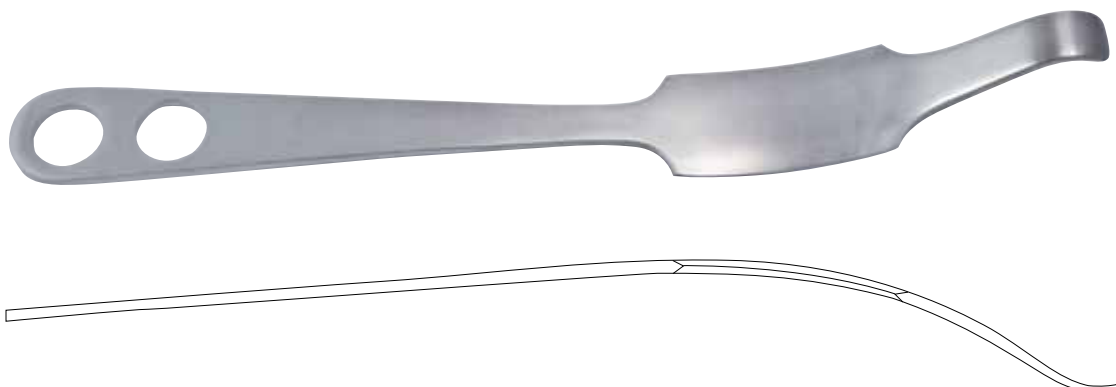

Knochenhebel
 Bone Levers
 Elevadores para hueso



Art.Nr.	Beschreibung Description	Size	Spez.
190-573-43	HOHMANN schmale Spitze narrow tip punta estrecha	23,5cm; 9 2/8" 43 mm	

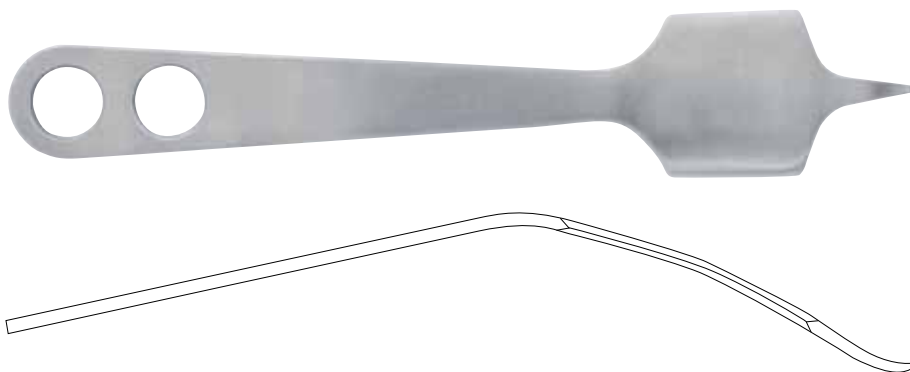

190-574-22	LANGE-HOHMANN breite Spitze mit Längsrille wide tip with groove punta ancha con rannura	25,0cm; 9 7/8" 22 mm	
------------	---	-------------------------	--

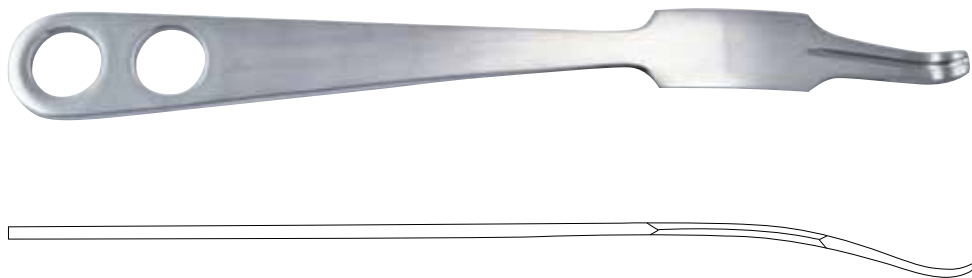

Kniehaken
Knee retractor
Separadores para rodilla

Art.Nr.	Beschreibung Description	Size	Spez.
190-575-26	BLOUNT stumpf blunt romo	26,5cm; 10 3/8" 38 mm	



190-576-26	BLOUNT	26,5cm; 10 3/8" 47 mm	
------------	--------	--------------------------	--



Knochenheber
 Bone Levers
 Elevadores para hueso

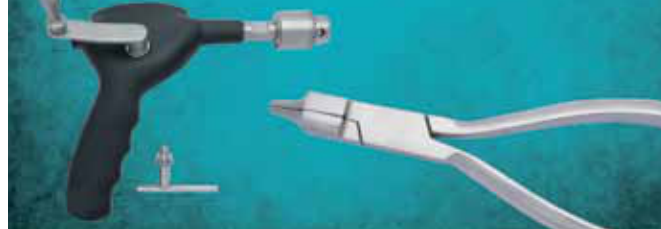

Art.Nr.	Beschreibung Description	Size	Spez.
---------	----------------------------	------	-------

TAYLOR	spitz sharp agudo	16,0cm; 6 2/8"	
--------	-------------------------	----------------	--



190-577-01	75 x 30 mm		
------------	------------	--	--

190-577-02	100 x 30 mm		
------------	-------------	--	--

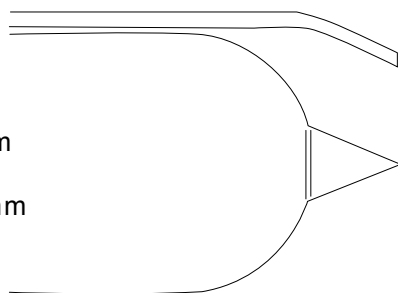

BENNETT	stumpf blunt romo		
---------	-------------------------	--	--

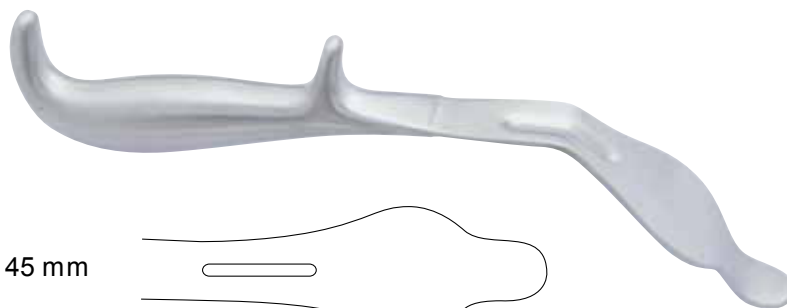

190-580-45	45 mm		
------------	-------	--	--

190-580-60	60 mm		
------------	-------	--	--

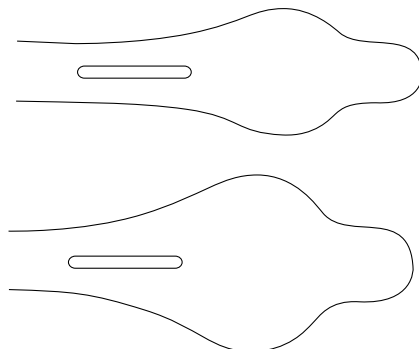

190

Extensionsbügel
 Bone Levers
 Elevadores para hueso

Art.Nr.	Beschreibung Description	Size	Spez.
---------	----------------------------	------	-------

BOEHLER

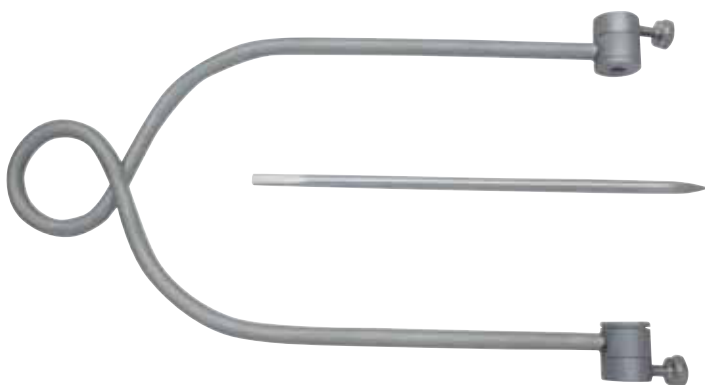

190-600-01	160 x 90 mm	für Arm for arm para brazo	6 2/8" x 4 4/8"
190-600-02	210 x 110 mm	für Oberschenkel und Knie for femur and knee para fémur y rodilla	8 2/8" x 4 4/8"
190-600-03	210 x 150 mm	für Oberschenkel und Knie for femur and knee para fémur y rodilla	8" x 6"

Extensionsbügel
 Bone Levers
 Elevadores para hueso



Art.Nr.	Beschreibung Description	Size	Spez.
---------	----------------------------	------	-------

KIRSCHNER mit 3 Zughaken
 with 3 traction hook
 con 3 ganchos de tracción



190-620-01	95 x 70 mm	für Kinder for children para niños	
------------	------------	---	--

190-620-03	105 x 105 mm	für Hand- und Fußgelenk for wrist and ankle para muñeco y tobillo	
------------	--------------	--	--

190-620-04	120 x 120 mm	für Ellenbogen for elbow para codo	
------------	--------------	---	--

190-620-06	155 x 155 mm	für Knie for knee para rodilla	
------------	--------------	-------------------------------------	--

190-620-07	200 x 155 mm	für Oberschenkel for femur para fémur	
------------	--------------	--	--

190-620-90	Spannschlüssel wire Strainer tensor de taladros f liformes	18,5cm; 7 7/8"	
------------	--	----------------	--



190

Extensionsbügel
 Bone Levers
 Elevadores para hueso

Art.Nr.	Beschreibung Description	Size	Spez.
---------	----------------------------	------	-------

KIRSCHNER mit 3 Zughaken
 with 3 traction hook
 con 3 ganchos de tracción



190-622-10 18,5cm; 7 2/8"

190-622-20 26,5cm; 10 4/8"

190-623-01 KIRSCHNER Zughaken für Extensionsbügel
 traction hook for extension bow
 gancho de tracción para estribos



190-625-01 Gabelschlüssel wrench 20,0cm; 8"

llave de tuercas



Extensionsbügel
 Bone Levers
 Elevadores para hueso



Art.Nr.	Beschreibung Description	Size	Spez.
---------	----------------------------	------	-------

KIRSCHNER mit 3 Zughaken
 with 3 traction hook
 con 3 ganchos de tracción



190-625-13 180 x 100 mm

190-625-26 270 x 160 mm

Drahtgeflecht für Finger
 wire mesh for fingers
 malla de alambre



190-628-01 klein
small | pequeño

190-628-02 mittel
medium | mediano

190-628-03 groß
big | grande

190

Extensionsnagel
Extension pin
Clavos de extensión

Art.Nr.	Beschreibung Description	Size	Spez.
	STEINMANN Trokarspitze with trocar point punta de trócar	Ø 4,0 mm	



212-348-14	14,0cm; 5 4/8"
212-348-16	16,0cm; 6 2/8"
212-348-18	18,0cm; 7"
212-348-20	20,0cm; 8"

Knochen Nagel
 Extension pin
 Clavo de extensión



Art.Nr.	Beschreibung Description	Size	Spez.
	KIRSCHNER Trokar-Rund trocar-round trócar-redondo		

	60 mm; 2 4/8"	120 mm; 5"	140 mm; 5 4/8"	160 mm; 6 2/8"	310 mm; 12 2/8"
Ø 1,0 mm	212-501-10	212-504-10	212-505-10	212-506-10	212-508-10
Ø 1,2 mm	212-501-12	212-504-12	212-505-12	212-506-12	212-508-12
Ø 1,4 mm	212-501-14	212-504-14	212-505-14	212-506-14	212-508-14
Ø 1,5 mm	212-501-15	212-504-15	212-505-15	212-506-15	212-508-15
Ø 1,6 mm	212-501-16	212-504-16	212-505-16	212-506-16	212-508-16
Ø 1,8 mm	212-501-18	212-504-18	212-505-18	212-506-18	212-508-18
Ø 2,0 mm	212-501-20	212-504-20	212-505-20	212-506-20	212-508-20
Ø 2,2 mm	212-501-22	212-504-22	212-505-22	212-506-22	212-508-22
Ø 2,5 mm				212-506-25	212-508-25

Pack á 10 Stück
 Box with 10 pieces | confección de 10 unidades

Knochnagel
 Extension pin
 Clavo de extensión

Art.Nr.	Beschreibung Description	Size	Spez.
	KIRSCHNER Trokar-Flach trocar-flat trócar-plano		

	60 mm; 2 4/8"	120 mm; 5"	140 mm; 5 4/8"	160 mm; 6 2/8"	310 mm; 12 2/8"
Ø 0,6 mm	212-511-06				
Ø 0,8 mm	212-511-08				
Ø 1,0 mm	212-511-10	212-514-10	212-515-10	212-516-10	212-518-10
Ø 1,2 mm	212-511-12	212-514-12	212-515-12	212-516-12	212-518-12
Ø 1,4 mm	212-511-14	212-514-14	212-515-14	212-516-14	212-518-14
Ø 1,5 mm	212-511-15	212-514-15	212-515-15	212-516-15	212-518-15
Ø 1,6 mm	212-511-16	212-514-16	212-515-16	212-516-16	212-518-16
Ø 1,8 mm	212-511-18	212-514-18	212-515-18	212-516-18	212-518-18
Ø 2,0 mm	212-511-20	212-514-20	212-515-20	212-516-20	212-518-20
Ø 2,2 mm	212-511-22	212-514-22	212-515-22	212-516-22	212-518-22
Ø 2,5 mm				212-516-25	212-518-25

Pack á 10 Stück
 Box with 10 pieces | confección de 10 unidades

Knochen Nagel
 Extension pin
 Clavo de extensión

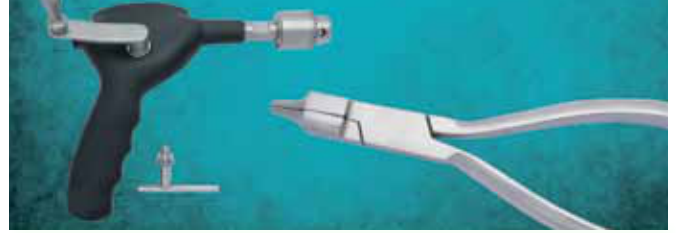

Art.Nr.	Beschreibung Description	Size	Spez.
	KIRSCHNER Trokar-Trokar trocar-Trocar trócar-Trócar		

	60 mm; 2 4/8"	120 mm; 5"	140 mm; 5 4/8"	160 mm; 6 2/8"	310 mm; 12 2/8"
Ø 0,6 mm	212-521-06	212-524-06			
Ø 0,8 mm	212-521-08	212-524-08	212-525-08		
Ø 1,0 mm	212-521-10	212-524-10	212-525-10	212-526-10	212-528-10
Ø 1,2 mm	212-521-12	212-524-12	212-525-12	212-526-12	212-528-12
Ø 1,4 mm	212-521-14	212-524-14	212-525-14	212-526-14	212-528-14
Ø 1,5 mm	212-521-15	212-524-15	212-525-15	212-526-15	212-528-15
Ø 1,6 mm	212-521-16	212-524-16	212-525-16	212-526-16	212-528-16
Ø 1,8 mm	212-521-18	212-524-18	212-525-18	212-526-18	212-528-18
Ø 2,0 mm	212-521-20	212-524-20	212-525-20	212-526-20	212-528-20
Ø 2,2 mm	212-521-22	212-524-22		212-526-22	212-528-22
Ø 2,5 mm	212-521-25	212-524-25	212-525-25	212-526-25	212-528-25

	230 mm; 9"
Ø 2,5 mm	212-527-25

Pack á 10 Stück
 Box with 10 pieces | confección de 10 unidades

190

Bohrdrahtspender
 K-Wire dispenser
 Dispensador para brocas f iliformes

Art.Nr. Beschreibung | Description Size Spez.

VICKERS



	Ø Drähte Ø wires Ø agujas	Drahtlänge wire lenght longitud agujas	
212-596-10	1,0 / 1,2 / 1,4 / 1,6 mm	10 cm	12,0cm; 4 6/8"
212-596-15	1,0 / 1,2 / 1,4 / 1,6 mm	16 cm	18,5cm; 7 2/8"
212-596-31	1,0 / 1,2 / 1,4 / 1,6 mm	31 cm	35,0cm; 14"
212-598-15	1,8 / 2,0 / 2,2 / 2,5 mm	16 cm	18,5cm; 7 2/8"
212-598-31	1,8 / 2,0 / 2,2 / 2,5 mm	31 cm	35,0cm; 14"

Flachzangen
 Flat Nose Pliers
 Alicates de pico plano



Art.Nr.	Beschreibung Description	Size	Spez.
---------	----------------------------	------	-------

parallel fassend
 parallel grip
 acción paralela

18,0cm; 7 1/8"



190-740-18

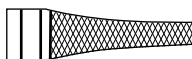

190-741-18



190-742-18

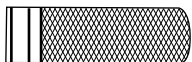

190-752-16 HACKSTOCK mit Längsrille
 with groove
 con ranura longitudinal

16,0cm; 6 2/8"

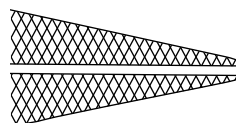

190-753-19 spitzes Maul
 sharp jaw
 boca aguda

19,0cm; 7 4/8"

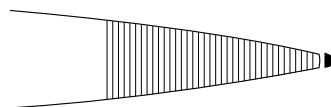

190

Flachzangen
 Flat Nose Pliers
 Alicates de pico plano

Art.Nr.	Beschreibung Description	Size	Spez.
---------	----------------------------	------	-------

flaches Maul
 flat jaw
 boca plano

17,0cm; 6 6/8"



190-755-01

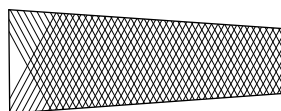

190-755-02

mit Kreuzrille
 with crosswise groove
 con ranura en form de cruz

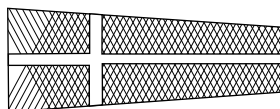

190-757-15

Kombinationszange
 Combi-Flat Nose Plier
 Combi-Alicate

15,0cm; 5 7/8"

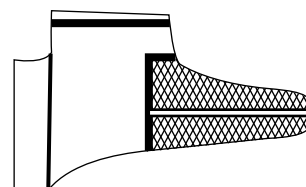

Flachzangen
 Flat Nose Pliers
 Alicates de pico plano



Art.Nr.	Beschreibung Description	Size	Spez.
	parallel fassend parallel grip acción paralela	18,0cm; 7 1/8"	

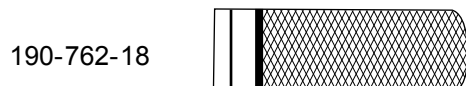

190-763-19		19,0cm; 7 4/8"	
------------	--	----------------	--

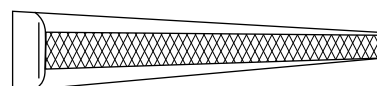

190-764-14		14,0cm; 5 3/8"	
------------	--	----------------	--

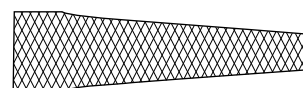

190

Tonnenzange; Parallelfasszange
Vise grip; Parallel plier
Alicates de pico plano

Art.Nr.	Beschreibung Description	Size	Spez.
---------	----------------------------	------	-------

190-765-18

18,0cm; 7 1/8"

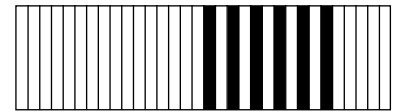

190-766-18

18,5cm; 7 2/8"

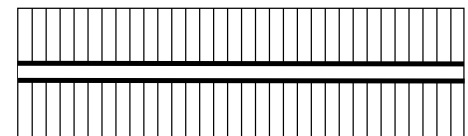
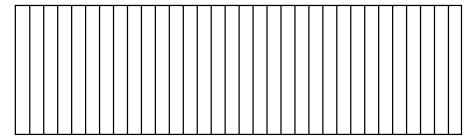
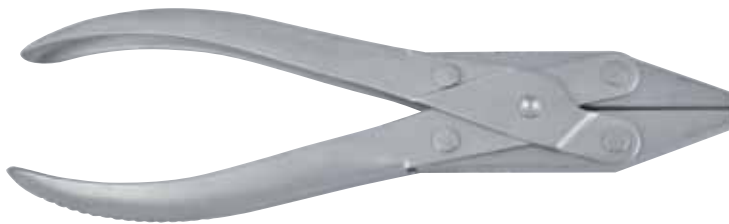

Drahtkneifzangen
Wire Cutting Pliers
Alicates para cortar alambre

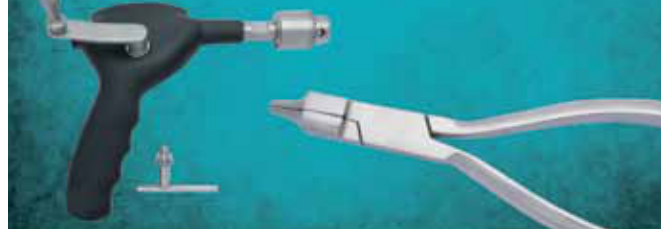

Art.Nr.	Beschreibung Description	Size	Spez.
---------	----------------------------	------	-------

190-768-18	für weiche Drähte bis Ø 2,4 mm for soft wires up to Ø 2,4 mm para alambres blandos hasta Ø 2,4 mm	18,5cm; 7 2/8" 13,5 mm	
------------	---	---------------------------	--

für harte Drähte bis Ø 1,8 mm
for hard wires up to Ø 1,8 mm
para alambres duros hasta Ø 1,8 mm



190-771-16	für weiche Drähte bis Ø 2,2 mm for soft wires up to Ø 2,2 mm para alambres blandos hasta Ø 2,2 mm	16,0cm; 6 2/8" 18,0 mm	
------------	---	---------------------------	--

für harte Drähte bis Ø 2,0 mm
for hard wires up to Ø 2,0 mm
para alambres duros hasta Ø 2,0 mm



190-770-15	für weiche Drähte bis Ø 2,0 mm for soft wires up to Ø 2,0 mm para alambres blandos hasta Ø 2,0 mm	15,0cm; 5 7/8" 14,5 mm	
------------	---	---------------------------	--

für harte Drähte bis Ø 1,2 mm
for hard wires up to Ø 1,2 mm
para alambres duros hasta Ø 1,2 mm



Seitenschneider
Wire Cutting Pliers
Alicates para cortar alambre

Art.Nr.	Beschreibung Description	Size	Spez.
190-772-18	<p>für weiche Drähte bis Ø 2,0 mm for soft wires up to Ø 2,0 mm para alambres blandos hasta Ø 2,0 mm</p> <p>für harte Drähte bis Ø 1,5 mm for hard wires up to Ø 1,5 mm para alambres duros hasta Ø 1,5 mm</p>	17,5cm; 6 7/8" 18,0 mm	TC
190-773-17	<p>für weiche Drähte bis Ø 2,0 mm for soft wires up to Ø 2,0 mm para alambres blandos hasta Ø 2,0 mm</p> <p>für harte Drähte bis Ø 1,7 mm for hard wires up to Ø 1,7 mm para alambres duros hasta Ø 1,7 mm</p>	17,0cm; 6 6/8"	TC
190-773-22	<p>für weiche Drähte bis Ø 2,8 mm for soft wires up to Ø 2,8 mm para alambres blandos hasta Ø 2,8 mm</p> <p>für harte Drähte bis Ø 2,2 mm for hard wires up to Ø 2,2 mm para alambres duros hasta Ø 2,2 mm</p>	23,0cm; 9"	TC

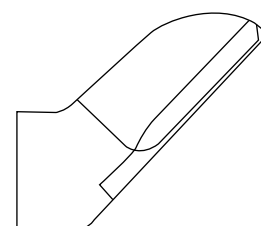
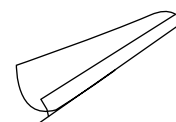

Seitenschneider; Kopfschneider
 Wire Cutting Pliers; Wire cutter front action
 Alicates para cortar alambre; Alicates frontal para cortar alambre

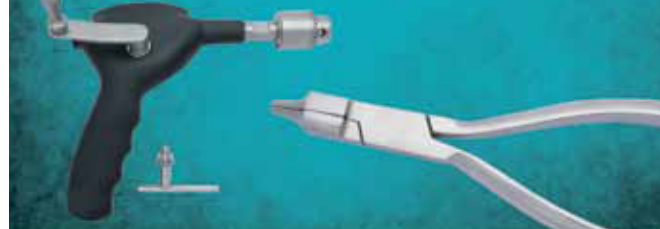

Art.Nr.	Beschreibung Description	Size	Spez.
---------	----------------------------	------	-------

190-774-23	für weiche Drähte bis Ø 3,0 mm for soft wires up to Ø 3,0 mm para alambres blandos hasta Ø 3,0 mm	23,0cm; 9"	
------------	---	------------	---

für harte Drähte bis Ø 2,2 mm
 for hard wires up to Ø 2,2 mm
 para alambres duros hasta Ø 2,2 mm

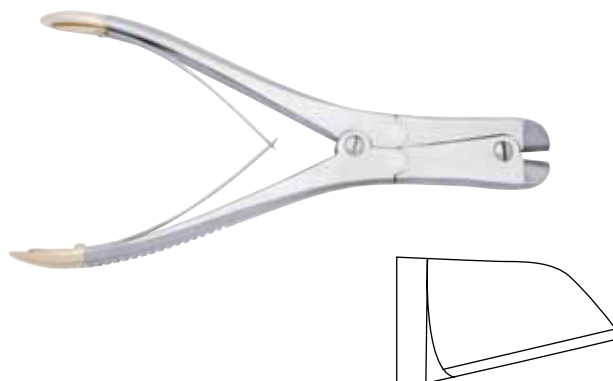

190-775-47	für Drähte und Schrauben bis Ø 6,0 mm for hard wires and screws up to Ø 6,0 mm Para alambres hasta Ø 6,0 mm	47,0cm; 17 3/4"
------------	---	-----------------



190-776-26	für weiche Drähte bis Ø 3,2 mm for soft wires up to Ø 3,2 mm para alambres blandos hasta Ø 3,2 mm	26,0cm; 10 2/8"	
------------	---	-----------------	---

für harte Drähte bis Ø 2,5 mm
 for hard wires up to Ø 2,5 mm
 para alambres duros hasta Ø 2,5 mm



Drahtspanner; Drahtumföhrungsnadel
 Wire tightener; Wire guides
 Tensor cierra-hilo; Agujas pasa-hilo

Art.Nr.	Beschreibung Description	Size	Spez.
190-780-21	LOUTE	21,0cm; 8 2/8"	



DEMEL



190-781-01	Fig. 1	groß big grande	31,0cm; 12 2/8"
------------	--------	-----------------------	-----------------

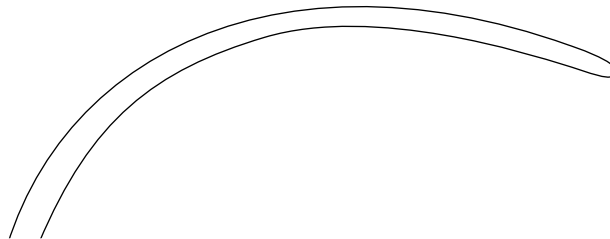

190-781-02	Fig. 2	mittel medium mediano	29,0cm; 11 3/8"
------------	--------	-----------------------------	-----------------

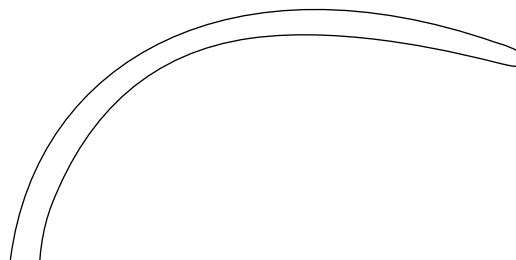

190-781-03	Fig. 3	klein small pequeño	28,0cm; 11"
------------	--------	---------------------------	-------------

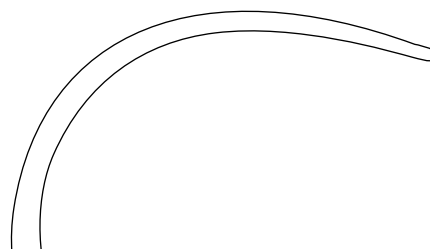

Stahldraht
 Bone wire
 Alambre para hueso

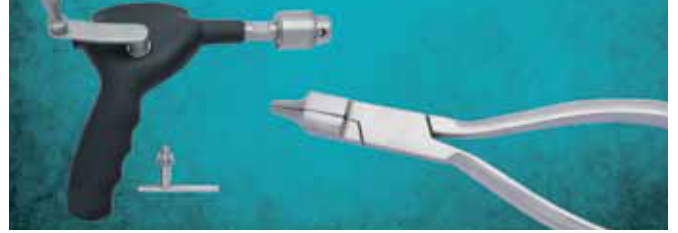

Art.Nr.	Beschreibung Description	Size	Spez.
---------	----------------------------	------	-------

Rolle mit 10 m
 coil of 10 m
 rollo de 10 m



- 190-795-02 Ø 0,2 mm
- 190-795-03 Ø 0,3 mm
- 190-795-04 Ø 0,4 mm
- 190-795-05 Ø 0,5 mm
- 190-795-06 Ø 0,6 mm
- 190-795-07 Ø 0,7 mm
- 190-795-08 Ø 0,8 mm
- 190-795-09 Ø 0,9 mm
- 190-795-10 Ø 1,0 mm
- 190-795-12 Ø 1,2 mm
- 190-795-15 Ø 1,5 mm

190

Weitere Artikel
further items
más artículos

Art.Nr.	Beschreibung Description	Size	Spez.
Other items available but not illustrated			
	ESMARCH compression bandage		
190-102-52	5m length, 8cm wide		
190-102-54	5m length, 10cm wide		
190-102-56	5m length, 12cm wide		
190-102-58	5m length, 15cm wide		
190-110-01	pump with manometer; registers up to 700mm HG		
190-132-20	HOPKINS plaster of paris knife	20,0cm; 8,0"	
190-144-19	WIGMORE plaster saw	19,0cm; 7,6"	
190-202-30	BEESON plaster cast spreader	30,0cm; 12"	
190-208-20	STILLE-MINI plaster shears	20,0cm; 8,0"	
190-210-01	CHARRIERE amputation saw; bow only	35,0cm; 14"	
190-212-01	BIER amputation saw; bow only	40,5cm; 16"	
	RUST amputation saw	39,0cm; 15,4"	
190-214-01	bow only		
190-214-39	with 4 saw blades		
	RUST saw blade		
190-215-06	6mm		
190-215-08	8mm		
190-215-15	15mm		
190-215-18	18mm		
190-217-20	LINDEMANN saw	20,0cm; 8,0"	
	CHARRIÈRE saw blade		
190-221-27	for saw 190-220-27		
190-221-30	for saw 190-220-30		
190-221-34	for saw 190-220-34		
190-244-16	bone reamer	16,0cm; 6,4"	
190-248-22	PERTHES reamer; t-shaped handle	22,0cm; 8,8"	
	STILLE-SHERMAN hand drill		
190-250-24	with 3 drills		
190-250-90	without drills		
	twist drill		
190-251-25	fig. 1, 2,5mm		
190-251-30	fig. 2, 3,0mm		
190-251-35	fig. 3, 3,5mm		

Weitere Artikel
further items
más artículos

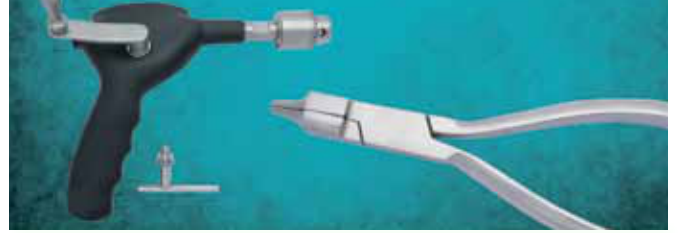

Art.Nr.	Beschreibung Description	Size	Spez.
Other items available but not illustrated			
190-260-01	STILLE; hand bone drill without drills		
190-270-01	HUDSON hand drill		
190-294-00 190-296-00	BUNNELL hand drill	28,0cm; 11,2"	
190-298-00	RALK universal hand drill	28,0cm; 11,2"	
190-303-00	drilling chuck		
190-303-10	handle with three-jaw-chuck		
190-305-00	KIRSCHNER hand drill complete		
190-314-00	quick-catch chuck only; for Borchardt shaft		
	Drill Bit		
190-315-15	5mm, round shaft, 70mm long		
190-315-25	5mm, round shaft, 95mm long		
190-315-30	5mm, round shaft, 100mm long		
190-315-50	5mm, round shaft, 132mm long		
190-318-00	DE MARTEL trepanation attachment; with guidung shaft		
	DE MARTEL burr		
190-320-06	Ø 6mm		
190-320-08	Ø 8mm		
190-320-10	Ø 10mm		
190-320-11	Ø 11mm		
190-320-12	Ø 12mm		

Weitere Artikel
further items
más artículos

Art.Nr.	Beschreibung Description	Size	Spez.
Other items available but not illustrated			
	LISTON bone cutting forceps		
190-520-14	straight	14,0cm; 5,6"	
190-520-17	straight	17,0cm; 6,8"	
190-520-19	straight	19,0cm; 7,6"	
190-520-22	straight	22,0cm; 8,8"	
190-521-14	curved	14,0cm; 5,6"	
190-521-17	curved	17,0cm; 6,8"	
190-521-19	curved	19,0cm; 7,6"	
190-521-22	curved	22,0cm; 8,8"	
190-560-17	WAGNER bone lever; 17mm wide	22,0cm; 8,8"	
190-562-18	HOHMANN bone lever; 18mm wide	22,0cm; 8,8"	
190-566-24	HOHMANN-ALDINGER bone lever; 24mm wide	28,5cm; 11,4"	
190-568-07	BUCK-GRAMCKO bone lever; 7,5mm wide	15,0cm; 6"	
	bone lever		
190-570-03	3mm wide	14,0cm; 5,6"	
190-570-06	5mm wide	15,0cm; 6"	
190-572-70	HOHMANN bone lever; 68mm; narrow tip	25,0cm; 10"	
	LANGE-HOHMANN bone lever		
190-574-30	30mm wide	26,5cm; 10,6"	
190-574-34	34mm wide	26,5cm; 10,6"	
190-577-17	BLOUNT knee retractor	17,5cm; 7"	
	HIBBS bone lever	24,0cm; 9,6"	
190-578-01	50x20mm		
190-578-02	75x25mm		
190-578-03	80x25mm		
190-582-30	MURPHY-LANE luxation lever; 30/18mm	30,0cm; 12"	
190-600-00	BOEHLER extension bow; 9x7,5cm		
	KIRSCHNER extension bow		
190-620-00	6x6cm		
190-620-02	9,5x11cm		
	KIRSCHNER wire traction bow		
190-620-05	135x130mm		
190-622-16	with traction hook adjustable		

Weitere Artikel
further items
más artículos

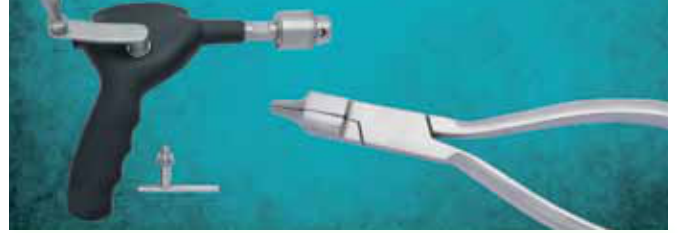

Art.Nr.	Beschreibung Description	Size	Spez.
Other items available but not illustrated			
190-623-02	traction hook, large; for traction bow		
190-626-00	fixation disc, slotted; for traction bow		
190-626-02	fixation disc; for traction bow		
190-626-10	screw driver; for fixation discs		
190-710-14	universal cramping plier SOFT WIRE Ø 1.5 MM, HARD WIRE Ø 1.0 MM	14,5cm; 5,8"	
190-712-16	wire bending and cutting plier HARD WIRE UP TO Ø 1.0 MM	16,0cm; 6,4"	
190-730-12	wire cutter SOFT WIRE Ø 0.6 MM/HARD Ø 0.4 MM	12,5cm; 5"	
190-732-18	SOFT WIRE Ø 2.0 MM, HARD WIRE Ø 1.7 MM	18,5cm; 7,4"	
190-750-00	NIRO wire forceps	15,0cm; 6"	
190-750-14	wire forceps	14,0cm; 5,6"	
190-751-14		14,0cm; 5,6"	
190-765-20	locking plier	20,0cm; 8,0"	
190-765-24		24,0cm; 9,6"	
190-767-18	Paralell Pliers; with lateral cutter	18,5cm; 7,4"	
190-776-47	wire cutter	47,0cm; 18,8"	
190-777-23		23,5cm; 9,4"	
190-778-21	combination plier and cutter	21,0cm; 8,4"	
190-779-21	TC wire cutting plier; soft wire up to Ø2,8mm; hard to Ø2,2mm	21,5cm; 8,6"	
190-784-24	cerclage instrument hollow, pointed, small curve	24,0cm; 9,6"	
190-784-27	hollow, pointed, large curve	24,0cm; 9,6"	
190-785-22	hollow, pointed, horizontal	22,0cm; 8,8"	

Weitere Artikel
further items
más artículos

Art.Nr.	Beschreibung Description	Size	Spez.
Other items available but not illustrated			
	STEINMANN pins		
212-301-10	trocar-round; 3,2mm	10,0cm; 4"	
212-301-15	trocar-round; 3,2mm	15,0cm; 6"	
212-301-18	trocar-round; 3,2mm	18,0cm; 7,2"	
212-301-20	trocar-round; 3,2mm	20,0cm; 8"	
212-301-22	trocar-round; 3,2mm	22,0cm; 8,8"	
212-301-23	trocar-round; 3,2mm	23,5cm; 9,4"	
212-301-25	trocar-round; 3,2mm	25,0cm; 10"	
212-301-28	trocar-round; 3,2mm	28,0cm; 11,2"	
212-301-30	trocar-round; 3,2mm	30,0cm; 12"	
212-302-10	trocar-round; 3,5mm	10,0cm; 4"	
212-302-15	trocar-round; 3,5mm	15,0cm; 6"	
212-302-18	trocar-round; 3,5mm	18,0cm; 7,2"	
212-302-20	trocar-round; 3,5mm	20,0cm; 8"	
212-302-22	trocar-round; 3,5mm	22,0cm; 8,8"	
212-302-23	trocar-round; 3,5mm	23,5cm; 9,4"	
212-302-25	trocar-round; 3,5mm	25,0cm; 10"	
212-302-28	trocar-round; 3,5mm	28,0cm; 11,2"	
212-302-30	trocar-round; 3,5mm	30,0cm; 12"	
212-303-10	trocar-round; 4,0mm	10,0cm; 4"	
212-303-15	trocar-round; 4,0mm	15,0cm; 6"	
212-303-18	trocar-round; 4,0mm	18,0cm; 7,2"	
212-303-20	trocar-round; 4,0mm	20,0cm; 8"	
212-303-22	trocar-round; 4,0mm	22,0cm; 8,8"	
212-303-23	trocar-round; 4,0mm	23,5cm; 9,4"	
212-303-25	trocar-round; 4,0mm	25,0cm; 10"	
212-303-28	trocar-round; 4,0mm	28,0cm; 11,2"	
212-303-30	trocar-round; 4,0mm	30,0cm; 12"	
212-304-10	trocar-round; 4,2mm	10,0cm; 4"	
212-304-15	trocar-round; 4,2mm	15,0cm; 6"	
212-304-18	trocar-round; 4,2mm	18,0cm; 7,2"	
212-304-20	trocar-round; 4,2mm	20,0cm; 8"	
212-304-22	trocar-round; 4,2mm	22,0cm; 8,8"	
212-304-23	trocar-round; 4,2mm	23,5cm; 9,4"	
212-304-25	trocar-round; 4,2mm	25,0cm; 10"	
212-304-28	trocar-round; 4,2mm	28,0cm; 11,2"	
212-304-30	trocar-round; 4,2mm	30,0cm; 12"	
212-305-10	trocar-round; 4,5mm	10,0cm; 4"	
212-305-15	trocar-round; 4,5mm	15,0cm; 6"	
212-305-18	trocar-round; 4,5mm	18,0cm; 7,2"	
212-305-20	trocar-round; 4,5mm	20,0cm; 8"	
212-305-22	trocar-round; 4,5mm	22,0cm; 8,8"	
212-305-23	trocar-round; 4,5mm	23,5cm; 9,4"	
212-305-25	trocar-round; 4,5mm	25,0cm; 10"	
212-305-28	trocar-round; 4,5mm	28,0cm; 11,2"	
212-305-30	trocar-round; 4,5mm	30,0cm; 12"	
212-306-10	trocar-round; 4,8mm	10,0cm; 4"	
212-306-15	trocar-round; 4,8mm	15,0cm; 6"	
212-306-18	trocar-round; 4,8mm	18,0cm; 7,2"	
212-306-20	trocar-round; 4,8mm	20,0cm; 8"	
212-306-22	trocar-round; 4,8mm	22,0cm; 8,8"	

Weitere Artikel
further items
más artículos

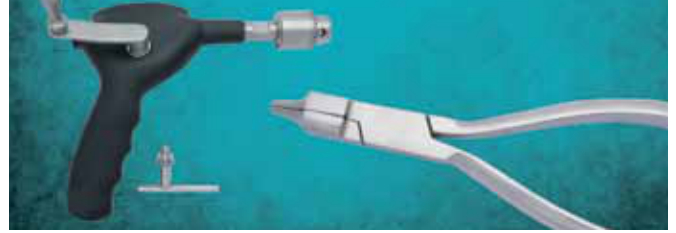

Art.Nr.	Beschreibung Description	Size	Spez.
Other items available but not illustrated			
	STEINMANN pins		
212-306-23	trocar-round; 4,8mm	23,5cm; 9,4"	
212-306-25	trocar-round; 4,8mm	25,0cm; 10"	
212-306-28	trocar-round; 4,8mm	28,0cm; 11,2"	
212-306-30	trocar-round; 4,8mm	30,0cm; 12"	
212-307-10	trocar-round; 5,0mm	10,0cm; 4"	
212-307-15	trocar-round; 5,0mm	15,0cm; 6"	
212-307-18	trocar-round; 5,0mm	18,0cm; 7,2"	
212-307-20	trocar-round; 5,0mm	20,0cm; 8"	
212-307-22	trocar-round; 5,0mm	22,0cm; 8,8"	
212-307-23	trocar-round; 5,0mm	23,5cm; 9,4"	
212-307-25	trocar-round; 5,0mm	25,0cm; 10"	
212-307-28	trocar-round; 5,0mm	28,0cm; 11,2"	
212-307-30	trocar-round; 5,0mm	30,0cm; 12"	
212-308-10	trocar-round; 5,0mm	10,0cm; 4"	
212-308-15	trocar-round; 5,5mm	15,0cm; 6"	
212-308-18	trocar-round; 5,5mm	18,0cm; 7,2"	
212-308-20	trocar-round; 5,5mm	20,0cm; 8"	
212-308-22	trocar-round; 5,5mm	22,0cm; 8,8"	
212-308-23	trocar-round; 5,5mm	23,5cm; 9,4"	
212-308-25	trocar-round; 5,5mm	25,0cm; 10"	
212-308-28	trocar-round; 5,5mm	28,0cm; 11,2"	
212-308-30	trocar-round; 5,5mm	30,0cm; 12"	
212-309-10	trocar-round; 6,0mm	10,0cm; 4"	
212-309-15	trocar-round; 6,0mm	15,0cm; 6"	
212-309-18	trocar-round; 6,0mm	18,0cm; 7,2"	
212-309-20	trocar-round; 6,0mm	20,0cm; 8"	
212-309-22	trocar-round; 6,0mm	22,0cm; 8,8"	
212-309-23	trocar-round; 6,0mm	23,5cm; 9,4"	
212-309-25	trocar-round; 6,0mm	25,0cm; 10"	
212-309-28	trocar-round; 6,0mm	28,0cm; 11,2"	
212-309-30	trocar-round; 6,0mm	30,0cm; 12"	
212-311-10	trocar-flat; 3,2mm	10,0cm; 4"	
212-311-15	trocar-flat; 3,2mm	15,0cm; 6"	
212-311-18	trocar-flat; 3,2mm	18,0cm; 7,2"	
212-311-20	trocar-flat; 3,2mm	20,0cm; 8"	
212-311-22	trocar-flat; 3,2mm	22,0cm; 8,8"	
212-311-23	trocar-flat; 3,2mm	23,5cm; 9,4"	
212-311-25	trocar-flat; 3,2mm	25,0cm; 10"	
212-311-28	trocar-flat; 3,2mm	28,0cm; 11,2"	
212-311-30	trocar-flat; 3,2mm	30,0cm; 12"	
212-312-10	trocar-flat; 3,5mm	10,0cm; 4"	
212-312-15	trocar-flat; 3,5mm	15,0cm; 6"	
212-312-18	trocar-flat; 3,5mm	18,0cm; 7,2"	
212-312-20	trocar-flat; 3,5mm	20,0cm; 8"	
212-312-22	trocar-flat; 3,5mm	22,0cm; 8,8"	
212-312-23	trocar-flat; 3,5mm	23,5cm; 9,4"	
212-312-25	trocar-flat; 3,5mm	25,0cm; 10"	
212-312-28	trocar-flat; 3,5mm	28,0cm; 11,2"	
212-312-30	trocar-flat; 3,5mm	30,0cm; 12"	
212-313-10	trocar-flat; 4,0mm	10,0cm; 4"	

190

Weitere Artikel
further items
más artículos

Art.Nr.	Beschreibung Description	Size	Spez.
Other items available but not illustrated			
	STEINMANN pins		
212-313-15	trocar-flat; 4,0mm	15,0cm; 6"	
212-313-18	trocar-flat; 4,0mm	18,0cm; 7,2"	
212-313-20	trocar-flat; 4,0mm	20,0cm; 8"	
212-313-22	trocar-flat; 4,0mm	22,0cm; 8,8"	
212-313-23	trocar-flat; 4,0mm	23,5cm; 9,4"	
212-313-25	trocar-flat; 4,0mm	25,0cm; 10"	
212-313-28	trocar-flat; 4,0mm	28,0cm; 11,2"	
212-313-30	trocar-flat; 4,0mm	30,0cm; 12"	
212-314-10	trocar-flat; 4,2mm	10,0cm; 4"	
212-314-15	trocar-flat; 4,2mm	15,0cm; 6"	
212-314-18	trocar-flat; 4,2mm	18,0cm; 7,2"	
212-314-20	trocar-flat; 4,2mm	20,0cm; 8"	
212-314-22	trocar-flat; 4,2mm	22,0cm; 8,8"	
212-314-23	trocar-flat; 4,2mm	23,5cm; 9,4"	
212-314-25	trocar-flat; 4,2mm	25,0cm; 10"	
212-314-28	trocar-flat; 4,2mm	28,0cm; 11,2"	
212-314-30	trocar-flat; 4,2mm	30,0cm; 12"	
212-315-10	trocar-flat; 4,5mm	10,0cm; 4"	
212-315-15	trocar-flat; 4,5mm	15,0cm; 6"	
212-315-18	trocar-flat; 4,5mm	18,0cm; 7,2"	
212-315-20	trocar-flat; 4,5mm	20,0cm; 8"	
212-315-22	trocar-flat; 4,5mm	22,0cm; 8,8"	
212-315-23	trocar-flat; 4,5mm	23,5cm; 9,4"	
212-315-25	trocar-flat; 4,5mm	25,0cm; 10"	
212-315-28	trocar-flat; 4,5mm	28,0cm; 11,2"	
212-315-30	trocar-flat; 4,5mm	30,0cm; 12"	
212-316-10	trocar-flat; 4,8mm	10,0cm; 4"	
212-316-15	trocar-flat; 4,8mm	15,0cm; 6"	
212-316-18	trocar-flat; 4,8mm	18,0cm; 7,2"	
212-316-20	trocar-flat; 4,8mm	20,0cm; 8"	
212-316-22	trocar-flat; 4,8mm	22,0cm; 8,8"	
212-316-23	trocar-flat; 4,8mm	23,5cm; 9,4"	
212-316-25	trocar-flat; 4,8mm	25,0cm; 10"	
212-316-28	trocar-flat; 4,8mm	28,0cm; 11,2"	
212-316-30	trocar-flat; 4,8mm	30,0cm; 12"	
212-317-10	trocar-flat; 5,0mm	10,0cm; 4"	
212-317-15	trocar-flat; 5,0mm	15,0cm; 6"	
212-317-18	trocar-flat; 5,0mm	18,0cm; 7,2"	
212-317-20	trocar-flat; 5,0mm	20,0cm; 8"	
212-317-22	trocar-flat; 5,0mm	22,0cm; 8,8"	
212-317-23	trocar-flat; 5,0mm	23,5cm; 9,4"	
212-317-25	trocar-flat; 5,0mm	25,0cm; 10"	
212-317-28	trocar-flat; 5,0mm	28,0cm; 11,2"	
212-317-30	trocar-flat; 5,0mm	30,0cm; 12"	
212-318-10	trocar-flat; 5,5mm	10,0cm; 4"	
212-318-15	trocar-flat; 5,5mm	15,0cm; 6"	
212-318-18	trocar-flat; 5,5mm	18,0cm; 7,2"	
212-318-20	trocar-flat; 5,5mm	20,0cm; 8"	
212-318-22	trocar-flat; 5,5mm	22,0cm; 8,8"	
212-318-23	trocar-flat; 5,5mm	23,5cm; 9,4"	

Weitere Artikel
further items
más artículos

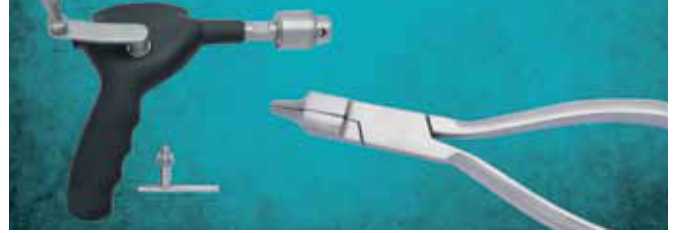

Art.Nr.	Beschreibung Description	Size	Spez.
Other items available but not illustrated			
	STEINMANN pins		
212-318-25	trocar-flat; 5,5mm	25,0cm; 10"	
212-318-28	trocar-flat; 5,5mm	28,0cm; 11,2"	
212-318-30	trocar-flat; 5,5mm	30,0cm; 12"	
212-319-10	trocar-flat; 6,0mm	10,0cm; 4"	
212-319-15	trocar-flat; 6,0mm	15,0cm; 6"	
212-319-18	trocar-flat; 6,0mm	18,0cm; 7,2"	
212-319-20	trocar-flat; 6,0mm	20,0cm; 8"	
212-319-22	trocar-flat; 6,0mm	22,0cm; 8,8"	
212-319-23	trocar-flat; 6,0mm	23,5cm; 9,4"	
212-319-25	trocar-flat; 6,0mm	25,0cm; 10"	
212-319-28	trocar-flat; 6,0mm	28,0cm; 11,2"	
212-319-30	trocar-flat; 6,0mm	30,0cm; 12"	
212-321-10	lancet-round; 3,2mm	10,0cm; 4"	
212-321-15	lancet-round; 3,2mm	15,0cm; 6"	
212-321-18	lancet-round; 3,2mm	18,0cm; 7,2"	
212-321-20	lancet-round; 3,2mm	20,0cm; 8"	
212-321-22	lancet-round; 3,2mm	22,0cm; 8,8"	
212-321-23	lancet-round; 3,2mm	23,5cm; 9,4"	
212-321-25	lancet-round; 3,2mm	25,0cm; 10"	
212-321-28	lancet-round; 3,2mm	28,0cm; 11,2"	
212-321-30	lancet-round; 3,2mm	30,0cm; 12"	
212-322-10	lancet-round; 3,5mm	10,0cm; 4"	
212-322-15	lancet-round; 3,5mm	15,0cm; 6"	
212-322-18	lancet-round; 3,5mm	18,0cm; 7,2"	
212-322-20	lancet-round; 3,5mm	20,0cm; 8"	
212-322-22	lancet-round; 3,5mm	22,0cm; 8,8"	
212-322-23	lancet-round; 3,5mm	30,0cm; 12"	
212-322-25	lancet-round; 3,5mm	25,0cm; 10"	
212-322-28	lancet-round; 3,5mm	28,0cm; 11,2"	
212-322-30	lancet-round; 3,5mm	30,0cm; 12"	
212-323-10	lancet-round; 4,0mm	10,0cm; 4"	
212-323-15	lancet-round; 4,0mm	15,0cm; 6"	
212-323-18	lancet-round; 4,0mm	18,0cm; 7,2"	
212-323-20	lancet-round; 4,0mm	20,0cm; 8"	
212-323-22	lancet-round; 4,0mm	22,0cm; 8,8"	
212-323-23	lancet-round; 4,0mm	23,5cm; 9,4"	
212-323-25	lancet-round; 4,0mm	25,0cm; 10"	
212-323-28	lancet-round; 4,0mm	28,0cm; 11,2"	
212-323-30	lancet-round; 4,0mm	30,0cm; 12"	
212-323-31	lancet-round; 4,0mm	31,0cm; 12,4"	
212-324-10	lancet-round; 4,2mm	10,0cm; 4"	
212-324-15	lancet-round; 4,2mm	15,0cm; 6"	
212-324-18	lancet-round; 4,2mm	18,0cm; 7,2"	
212-324-20	lancet-round; 4,2mm	20,0cm; 8"	
212-324-22	lancet-round; 4,2mm	22,0cm; 8,8"	
212-324-23	lancet-round; 4,2mm	23,5cm; 9,4"	
212-324-25	lancet-round; 4,2mm	25,0cm; 10"	
212-324-28	lancet-round; 4,2mm	28,0cm; 11,2"	
212-324-30	lancet-round; 4,2mm	30,0cm; 12"	
212-325-10	lancet-round; 4,5mm	10,0cm; 4"	

Weitere Artikel
further items
más artículos

Art.Nr.	Beschreibung Description	Size	Spez.
Other items available but not illustrated			
STEINMANN pins			
212-325-15	lancet-round; 4,5mm	15,0cm; 6"	
212-325-18	lancet-round; 4,5mm	18,0cm; 7,2"	
212-325-20	lancet-round; 4,5mm	20,0cm; 8"	
212-325-22	lancet-round; 4,5mm	22,0cm; 8,8"	
212-325-23	lancet-round; 4,5mm	23,5cm; 9,4"	
212-325-25	lancet-round; 4,5mm	25,0cm; 10"	
212-325-28	lancet-round; 4,5mm	28,0cm; 11,2"	
212-325-30	lancet-round; 4,5mm	30,0cm; 12"	
212-326-10	lancet-round; 4,8mm	10,0cm; 4"	
212-326-15	lancet-round; 4,8mm	15,0cm; 6"	
212-326-18	lancet-round; 4,8mm	18,0cm; 7,2"	
212-326-20	lancet-round; 4,8mm	20,0cm; 8"	
212-326-22	lancet-round; 4,8mm	22,0cm; 8,8"	
212-326-23	lancet-round; 4,8mm	23,5cm; 9,4"	
212-326-25	lancet-round; 4,8mm	25,0cm; 10"	
212-326-28	lancet-round; 4,8mm	28,0cm; 11,2"	
212-326-30	lancet-round; 4,8mm	30,0cm; 12"	
212-327-10	lancet-round; 5,0mm	10,0cm; 4"	
212-327-15	lancet-round; 5,0mm	15,0cm; 6"	
212-327-18	lancet-round; 5,0mm	18,0cm; 7,2"	
212-327-20	lancet-round; 5,0mm	20,0cm; 8"	
212-327-22	lancet-round; 5,0mm	22,0cm; 8,8"	
212-327-23	lancet-round; 5,0mm	23,5cm; 9,4"	
212-327-25	lancet-round; 5,0mm	25,0cm; 10"	
212-327-28	lancet-round; 5,0mm	28,0cm; 11,2"	
212-327-30	lancet-round; 5,0mm	30,0cm; 12"	
212-328-10	lancet-round; 5,5mm	10,0cm; 4"	
212-328-15	lancet-round; 5,5mm	15,0cm; 6"	
212-328-18	lancet-round; 5,5mm	18,0cm; 7,2"	
212-328-20	lancet-round; 5,5mm	20,0cm; 8"	
212-328-22	lancet-round; 5,5mm	22,0cm; 8,8"	
212-328-23	lancet-round; 5,5mm	23,5cm; 9,4"	
212-328-25	lancet-round; 5,5mm	25,0cm; 10"	
212-328-28	lancet-round; 5,5mm	28,0cm; 11,2"	
212-328-30	lancet-round; 5,5mm	30,0cm; 12"	
212-329-10	lancet-round; 6,0mm	10,0cm; 4"	
212-329-15	lancet-round; 6,0mm	15,0cm; 6"	
212-329-18	lancet-round; 6,0mm	18,0cm; 7,2"	
212-329-20	lancet-round; 6,0mm	20,0cm; 8"	
212-329-22	lancet-round; 6,0mm	22,0cm; 8,8"	
212-329-23	lancet-round; 6,0mm	23,5cm; 9,4"	
212-329-25	lancet-round; 6,0mm	25,0cm; 10"	
212-329-28	lancet-round; 6,0mm	28,0cm; 11,2"	
212-329-30	lancet-round; 6,0mm	30,0cm; 12"	
212-331-10	lancet-flat; 3,2mm	10,0cm; 4"	
212-331-15	lancet-flat; 3,2mm	15,0cm; 6"	
212-331-18	lancet-flat; 3,2mm	18,0cm; 7,2"	
212-331-20	lancet-flat; 3,2mm	20,0cm; 8"	
212-331-22	lancet-flat; 3,2mm	22,0cm; 8,8"	
212-331-23	lancet-flat; 3,2mm	23,5cm; 9,4"	

Weitere Artikel
further items
más artículos

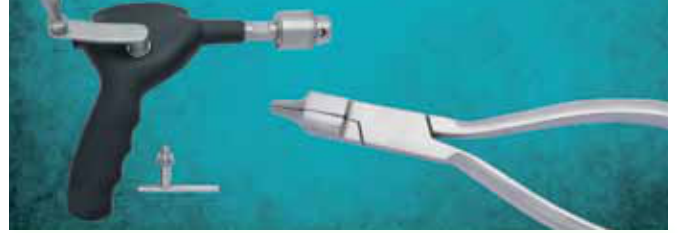

Art.Nr.	Beschreibung Description	Size	Spez.
Other items available but not illustrated			
	STEINMANN pins		
212-331-25	lancet-flat; 3,2mm	25,0cm; 10"	
212-331-28	lancet-flat; 3,2mm	28,0cm; 11,2"	
212-331-30	lancet-flat; 3,2mm	30,0cm; 12"	
212-332-10	lancet-flat; 3,5mm	10,0cm; 4"	
212-332-15	lancet-flat; 3,5mm	15,0cm; 6"	
212-332-18	lancet-flat; 3,5mm	18,0cm; 7,2"	
212-332-20	lancet-flat; 3,5mm	20,0cm; 8"	
212-332-22	lancet-flat; 3,5mm	22,0cm; 8,8"	
212-332-23	lancet-flat; 3,5mm	23,5cm; 9,4"	
212-332-25	lancet-flat; 3,5mm	25,0cm; 10"	
212-332-28	lancet-flat; 3,5mm	28,0cm; 11,2"	
212-332-30	lancet-flat; 3,5mm	30,0cm; 12"	
212-333-10	lancet-flat; 4,0mm	10,0cm; 4"	
212-333-15	lancet-flat; 4,0mm	15,0cm; 6"	
212-333-18	lancet-flat; 4,0mm	18,0cm; 7,2"	
212-333-20	lancet-flat; 4,0mm	20,0cm; 8"	
212-333-22	lancet-flat; 4,0mm	22,0cm; 8,8"	
212-333-23	lancet-flat; 4,0mm	23,5cm; 9,4"	
212-333-25	lancet-flat; 4,0mm	25,0cm; 10"	
212-333-28	lancet-flat; 4,0mm	28,0cm; 11,2"	
212-333-30	lancet-flat; 4,0mm	30,0cm; 12"	
212-334-10	lancet-flat; 4,2mm	10,0cm; 4"	
212-334-15	lancet-flat; 4,2mm	15,0cm; 6"	
212-334-18	lancet-flat; 4,2mm	18,0cm; 7,2"	
212-334-20	lancet-flat; 4,2mm	20,0cm; 8"	
212-334-22	lancet-flat; 4,2mm	22,0cm; 8,8"	
212-334-23	lancet-flat; 4,2mm	23,5cm; 9,4"	
212-334-25	lancet-flat; 4,2mm	25,0cm; 10"	
212-334-28	lancet-flat; 4,2mm	28,0cm; 11,2"	
212-334-30	lancet-flat; 4,2mm	30,0cm; 12"	
212-335-10	lancet-flat; 4,5mm	10,0cm; 4"	
212-335-15	lancet-flat; 4,5mm	15,0cm; 6"	
212-335-18	lancet-flat; 4,5mm	18,0cm; 7,2"	
212-335-20	lancet-flat; 4,5mm	20,0cm; 8"	
212-335-22	lancet-flat; 4,5mm	22,0cm; 8,8"	
212-335-23	lancet-flat; 4,5mm	23,5cm; 9,4"	
212-335-25	lancet-flat; 4,5mm	25,0cm; 10"	
212-335-28	lancet-flat; 4,5mm	28,0cm; 11,2"	
212-335-30	lancet-flat; 4,5mm	30,0cm; 12"	
212-336-10	lancet-flat; 4,8mm	10,0cm; 4"	
212-336-15	lancet-flat; 4,8mm	15,0cm; 6"	
212-336-18	lancet-flat; 4,8mm	18,0cm; 7,2"	
212-336-20	lancet-flat; 4,8mm	20,0cm; 8"	
212-336-22	lancet-flat; 4,8mm	22,0cm; 8,8"	
212-336-23	lancet-flat; 4,8mm	23,5cm; 9,4"	
212-336-25	lancet-flat; 4,8mm	25,0cm; 10"	
212-336-28	lancet-flat; 4,8mm	28,0cm; 11,2"	
212-336-30	lancet-flat; 4,8mm	30,0cm; 12"	
212-337-10	lancet-flat; 5,0mm	10,0cm; 4"	
212-337-15	lancet-flat; 5,0mm	15,0cm; 6"	

Weitere Artikel
further items
más artículos

Art.Nr.	Beschreibung Description	Size	Spez.
Other items available but not illustrated			
STEINMANN pins			
212-337-18	lancet-flat; 5,0mm	18,0cm; 7,2"	
212-337-20	lancet-flat; 5,0mm	20,0cm; 8"	
212-337-22	lancet-flat; 5,0mm	22,0cm; 8,8"	
212-337-23	lancet-flat; 5,0mm	23,5cm; 9,4"	
212-337-25	lancet-flat; 5,0mm	25,0cm; 10"	
212-337-28	lancet-flat; 5,0mm	28,0cm; 11,2"	
212-337-30	lancet-flat; 5,0mm	30,0cm; 12"	
212-338-10	lancet-flat; 5,5mm	10,0cm; 4"	
212-338-15	lancet-flat; 5,5mm	15,0cm; 6"	
212-338-18	lancet-flat; 5,5mm	18,0cm; 7,2"	
212-338-20	lancet-flat; 5,5mm	20,0cm; 8"	
212-338-22	lancet-flat; 5,5mm	22,0cm; 8,8"	
212-338-23	lancet-flat; 5,5mm	23,5cm; 9,4"	
212-338-25	lancet-flat; 5,5mm	25,0cm; 10"	
212-338-28	lancet-flat; 5,5mm	28,0cm; 11,2"	
212-338-30	lancet-flat; 5,5mm	30,0cm; 12"	
212-339-10	lancet-flat; 6,0mm	10,0cm; 4"	
212-339-15	lancet-flat; 6,0mm	15,0cm; 6"	
212-339-18	lancet-flat; 6,0mm	18,0cm; 7,2"	
212-339-20	lancet-flat; 6,0mm	20,0cm; 8"	
212-339-22	lancet-flat; 6,0mm	22,0cm; 8,8"	
212-339-23	lancet-flat; 6,0mm	23,5cm; 9,4"	
212-339-25	lancet-flat; 6,0mm	25,0cm; 10"	
212-339-28	lancet-flat; 6,0mm	28,0cm; 11,2"	
212-339-30	lancet-flat; 6,0mm	30,0cm; 12"	
STEINMANN extension pin; with trocar point; triangular shaft			
212-348-08	Ø 4,0mm	8,0cm; 3,2"	
212-348-10	Ø 4,0mm	10,0cm; 4"	
212-348-12	Ø 4,0mm	12,0cm; 4,8"	
212-348-13	Ø 4,0mm	13,0cm; 5,2"	
212-348-15	Ø 4,0mm	15,0cm; 6"	
212-348-21	Ø 4,0mm	21,0cm; 8,4"	
212-348-25	Ø 4,0mm	25,0cm; 10"	
SCHANZ pins			
212-380-30	3,0mm	10,0cm; 4"	
212-380-35	3,5mm	10,0cm; 4"	
212-380-40	4,0mm	10,0cm; 4"	
212-380-45	4,5mm	10,0cm; 4"	
212-380-50	5,0mm	10,0cm; 4"	
212-382-30	3,0mm	12,0cm; 4,8"	
212-382-35	3,5mm	12,0cm; 4,8"	
212-382-40	4,0mm	12,0cm; 4,8"	
212-382-45	4,5mm	12,0cm; 4,8"	
212-382-50	5,0mm	12,0cm; 4,8"	
212-385-30	3,0mm	15,0cm; 6"	
212-385-35	3,5mm	15,0cm; 6"	
212-385-40	4,0mm	15,0cm; 6"	
212-385-45	4,5mm	15,0cm; 6"	

Weitere Artikel
further items
más artículos

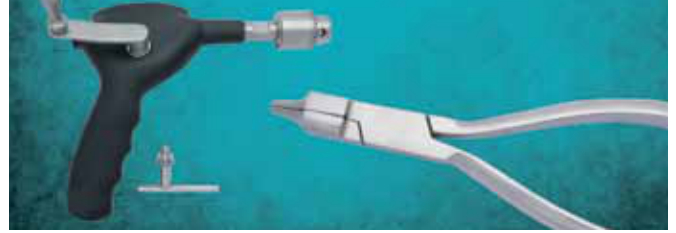

Art.Nr.	Beschreibung Description	Size	Spez.
---------	----------------------------	------	-------

Other items available but not illustrated

Art.Nr.	Beschreibung Description	Size	Spez.
SCHANZ pins			
212-385-50	5,0mm	15,0cm; 6"	
212-387-30	3,0mm	17,0cm; 6,8"	
212-387-35	3,5mm	17,0cm; 6,8"	
212-387-40	4,0mm	17,0cm; 6,8"	
212-387-45	4,5mm	17,0cm; 6,8"	
212-387-50	5,0mm	17,0cm; 6,8"	
212-390-30	3,0mm	20,0cm; 8"	
212-390-35	3,5mm	20,0cm; 8"	
212-390-40	4,0mm	20,0cm; 8"	
212-390-45	4,5mm	20,0cm; 8"	
212-390-50	5,0mm	20,0cm; 8"	
212-395-30	3,0mm	25,0cm; 10"	
212-395-35	3,5mm	25,0cm; 10"	
212-395-40	4,0mm	25,0cm; 10"	
212-395-45	4,5mm	25,0cm; 10"	
212-395-50	5,0mm	25,0cm; 10"	

KIRSCHNER wire drills; box with 10 pieces

212-501-06	trocar-round; 0,6 / 60mm
212-501-07	trocar-round; 0,7 / 60mm
212-501-08	trocar-round; 0,8 / 60mm
212-501-09	trocar-round; 0,9 / 60mm
212-501-17	trocar-round; 1,7 / 60mm
212-501-25	trocar-round; 2,5 / 60mm
212-501-30	trocar-round; 3,0 / 60mm
212-502-06	trocar-round; 0,6 / 70mm
212-502-07	trocar-round; 0,7 / 70mm
212-502-08	trocar-round; 0,8 / 70mm
212-502-09	trocar-round; 0,9 / 70mm
212-502-10	trocar-round; 1,0 / 70mm
212-502-12	trocar-round; 1,2 / 70mm
212-502-14	trocar-round; 1,4 / 70mm
212-502-15	trocar-round; 1,5 / 70mm
212-502-16	trocar-round; 1,6 / 70mm
212-502-17	trocar-round; 1,7 / 70mm
212-502-18	trocar-round; 1,8 / 70mm
212-502-20	trocar-round; 2,0 / 70mm
212-502-22	trocar-round; 2,2 / 70mm
212-502-25	trocar-round; 2,5 / 70mm
212-502-30	trocar-round; 3,0 / 70mm
212-503-06	trocar-round; 0,6 / 80mm
212-503-07	trocar-round; 0,7 / 80mm
212-503-08	trocar-round; 0,8 / 80mm
212-503-09	trocar-round 0,9 / 80mm
212-503-10	trocar-round; 1,0 / 80mm
212-503-12	trocar-round; 1,2 / 80mm
212-503-14	trocar-round; 1,4 / 80mm
212-503-15	trocar-round; 1,5 / 80mm
212-503-16	trocar-round; 1,6 / 80mm
212-503-17	trocar-round 1,7 / 80mm

Weitere Artikel
 further items
 más artículos

Art.Nr.	Beschreibung Description	Size	Spez.
---------	----------------------------	------	-------

Other items available but not illustrated

	KIRSCHNER wire drills; box with 10 pieces		
212-503-18	trocar-round; 1,8 / 80mm		
212-503-20	trocar-round; 2,0 / 80mm		
212-503-22	trocar-round; 2,2 / 80mm		
212-503-25	trocar-round; 2,5 / 80mm		
212-503-30	trocar-round; 3,0 / 80mm		
212-504-06	trocar-round; 0,6 / 120mm		
212-504-07	trocar-round; 0,7 / 120mm		
212-504-08	trocar-round; 0,8 / 120mm		
212-504-09	trocar-round; 0,9 / 120mm		
212-504-17	trocar-round; 1,7 / 120mm		
212-504-25	trocar-round; 2,5 / 120mm		
212-504-30	trocar-round; 3,0 / 120mm		
212-505-06	trocar-round; 0,6 / 140mm		
212-505-07	trocar-round; 0,7 / 140mm		
212-505-08	trocar-round; 0,8 / 140mm		
212-505-09	trocar-round; 0,9 / 140mm		
212-505-17	trocar-round; 1,7 / 140mm		
212-505-25	trocar-round; 2,5 / 140mm		
212-505-30	trocar-round; 3,0 / 140mm		
212-506-06	trocar-round; 0,6 / 160mm		
212-506-07	trocar-round; 0,7 / 160mm		
212-506-08	trocar-round 0,8 / 160mm		
212-506-09	trocar-round; 0,9 / 160mm		
212-506-17	trocar-round; 1,7 / 160mm		
212-506-30	trocar-round; 3,0 / 160mm		
212-507-06	trocar-round; 0,6 / 230mm		
212-507-07	trocar-round; 0,7 / 230mm		
212-507-08	trocar-round; 0,8 / 230mm		
212-507-09	trocar-round; 0,9 / 230mm		
212-507-10	trocar-round; 1,0 / 230mm		
212-507-12	trocar-round; 1,2 / 230mm		
212-507-14	trocar-round; 1,4 / 230mm		
212-507-15	trocar-round; 1,5 / 230mm		
212-507-16	trocar-round; 1,6 / 230mm		
212-507-17	trocar-round; 1,7 / 230mm		
212-507-18	trocar-round; 1,8 / 230mm		
212-507-20	trocar-round; 2,0 / 230mm		
212-507-22	trocar-round; 2,2 / 230mm		
212-507-25	trocar-round; 2,5 / 230mm		
212-507-30	trocar-round; 3,0 / 230mm		
212-508-06	trocar-round; 0,6 / 310mm		
212-508-07	trocar-round; 0,7 / 310mm		
212-508-08	trocar-round; 0,8 / 310mm		
212-508-09	trocar-round; 0,9 / 310mm		
212-508-17	trocar-round; 1,7 / 310mm		
212-508-28	trocar-round; 2,8 / 310mm		
212-508-30	trocar-round; 3,0 / 310mm		
212-511-07	trocar-flat ; 0,7 / 60mm		
212-511-09	trocar-flat; 0,9 / 60mm		
212-511-17	trocar-flat ; 1,7 / 60mm		

Weitere Artikel
further items
más artículos



Art.Nr.	Beschreibung Description	Size	Spez.
---------	----------------------------	------	-------

Other items available but not illustrated

KIRSCHNER wire drills; box with 10 pieces

- 212-511-25 trocar-flat; 2,5 / 60mm
- 212-511-30 trocar-flat; 3,0 / 60mm
- 212-512-06 trocar-flat; 0,6 / 70mm
- 212-512-07 trocar-flat; 0,7 / 70mm
- 212-512-08 trocar-flat; 0,8 / 70mm
- 212-512-09 trocar-flat; 0,9 / 70mm
- 212-512-10 trocar-flat; 1,0 / 70mm
- 212-512-12 trocar-flat; 1,2 / 70mm
- 212-512-14 trocar-flat; 1,4 / 70mm
- 212-512-15 trocar-flat; 1,5 / 70mm
- 212-512-16 trocar-flat; 1,6 / 70mm
- 212-512-17 trocar-flat; 1,7 / 70mm
- 212-512-18 trocar-flat; 1,8 / 70mm
- 212-512-20 trocar-flat; 2,0 / 70mm
- 212-512-22 trocar-flat; 2,2 / 70mm
- 212-512-25 trocar-flat; 2,5 / 70mm
- 212-512-30 trocar-flat; 3,0 / 70mm
- 212-513-06 trocar-flat; 0,6 / 80mm
- 212-513-07 trocar-flat; 0,7 / 80mm
- 212-513-08 trocar-flat; 0,8 / 80mm
- 212-513-09 trocar-flat; 0,9 / 80mm
- 212-513-10 trocar-flat; 1,0 / 80mm
- 212-513-12 trocar-flat; 1,2 / 80mm
- 212-513-14 trocar-flat; 1,4 / 80mm
- 212-513-15 trocar-flat; 1,5 / 80mm
- 212-513-16 trocar-flat; 1,6 / 80mm
- 212-513-17 trocar-flat; 1,7 / 80mm
- 212-513-18 trocar-flat; 1,8 / 80mm
- 212-513-20 trocar-flat; 2,0 / 80mm
- 212-513-22 trocar-flat; 2,2 / 80mm
- 212-513-25 trocar-flat; 2,5 / 80mm
- 212-513-30 trocar-flat; 3,0 / 80mm
- 212-514-06 trocar-flat; 0,6 / 120mm
- 212-514-07 trocar-flat; 0,7 / 120mm
- 212-514-08 trocar-flat; 0,8 / 120mm
- 212-514-09 trocar-flat; 0,9 / 120mm
- 212-514-17 trocar-flat; 1,7 / 120mm
- 212-514-25 trocar-flat; 2,5 / 120mm
- 212-514-30 trocar-flat; 3,0 / 120mm
- 212-515-06 trocar-flat; 0,6 / 140mm
- 212-515-07 trocar-flat; 0,7 / 140mm
- 212-515-08 trocar-flat; 0,8 / 140mm
- 212-515-09 trocar-flat; 0,9 / 140mm
- 212-515-17 trocar-flat; 1,7 / 140mm
- 212-515-25 trocar-flat; 2,5 / 140mm
- 212-515-30 trocar-flat; 3,0 / 140mm
- 212-516-06 trocar-flat; 0,6 / 160mm
- 212-516-07 trocar-flat; 0,7 / 160mm
- 212-516-08 trocar-flat; 0,8 / 160mm
- 212-516-09 trocar-flat; 0,9 / 160mm

Weitere Artikel
 further items
 más artículos

Art.Nr.	Beschreibung Description	Size	Spez.
---------	----------------------------	------	-------

Other items available but not illustrated

	KIRSCHNER wire drills; box with 10 pieces		
212-516-17	trocar-flat; 1,7 / 160mm		
212-516-30	trocar-flat; 3,0 / 160mm		
212-517-06	trocar-flat; 0,6 / 230mm		
212-517-07	trocar-flat; 0,7 / 230mm		
212-517-08	trocar-flat; 0,8 / 230mm		
212-517-09	trocar-flat; 0,9 / 230mm		
212-517-10	trocar-flat; 1,0 / 230mm		
212-517-12	trocar-flat; 1,2 / 230mm		
212-517-14	trocar-flat; 1,4 / 230mm		
212-517-15	trocar-flat; 1,5 / 230mm		
212-517-16	trocar-flat; 1,6 / 230mm		
212-517-17	trocar-flat; 1,7 / 230mm		
212-517-18	trocar-flat; 1,8 / 230mm		
212-517-20	trocar-flat; 2,0 / 230mm		
212-517-22	trocar-flat; 2,2 / 230mm		
212-517-25	trocar-flat; 2,5 / 230mm		
212-517-30	trocar-flat; 3,0 / 230mm		
212-518-06	trocar-flat; 0,6 / 310mm		
212-518-07	trocar-flat; 0,7 / 310mm		
212-518-08	trocar-flat; 0,8 / 310mm		
212-518-09	trocar-flat; 0,9 / 310mm		
212-518-17	trocar-flat; 1,7 / 310mm		
212-518-30	trocar-flat; 3,0 / 310mm		
212-521-07	trocar-trocar; 0,7 / 60mm		
212-521-09	trocar-trocar; 0,9 / 60mm		
212-521-17	trocar-trocar; 1,7 / 60mm		
212-521-30	trocar-trocar; 3,0 / 60mm		
212-522-06	trocar-trocar; 0,6 / 70mm		
212-522-07	trocar-trocar; 0,7 / 70mm		
212-522-08	trocar-trocar; 0,8 / 70mm		
212-522-09	trocar-trocar; 0,9 / 70mm		
212-522-10	trocar-trocar; 1,0 / 70mm		
212-522-12	trocar-trocar 1,2 / 70mm		
212-522-14	trocar-trocar; 1,4 / 70mm		
212-522-15	trocar-trocar; 1,5 / 70mm		
212-522-16	trocar-trocar; 1,6 / 70mm		
212-522-17	trocar-trocar; 1,7 / 70mm		
212-522-18	trocar-trocar; 1,8 / 70mm		
212-522-20	trocar-trocar; 2,0 / 70mm		
212-522-22	trocar-trocarr; 2,2 / 70mm		
212-522-25	trocar-trocar; 2,5 / 70mm		
212-522-30	trocar-trocar; 3,0 / 70mm		
212-523-06	trocar-trocar; 0,6 / 80mm		
212-523-07	trocar-trocar; 0,7 / 80mm		
212-523-08	trocar-trocar; 0,8 / 80mm		
212-523-09	trocar-trocar; 0,9 / 80mm		
212-523-10	trocar-trocar; 1,0 / 80mm		
212-523-12	trocar-trocar; 1,2 / 80mm		
212-523-14	trocar-trocar; 1,4 / 80mm		
212-523-15	trocar-trocar; 1,5 / 80mm		

Weitere Artikel
further items
más artículos

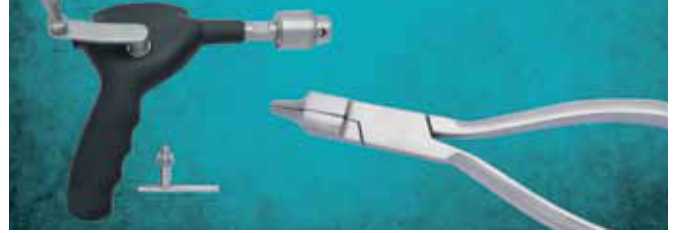

Art.Nr.	Beschreibung Description	Size	Spez.
---------	----------------------------	------	-------

Other items available but not illustrated

KIRSCHNER wire drills; box with 10 pieces

- | | |
|------------|-----------------------------|
| 212-523-16 | trocar-trocar; 1,6 / 80mm |
| 212-523-17 | trocar-trocar; 1,7 / 80mm |
| 212-523-18 | trocar-trocar; 1,8 / 80mm |
| 212-523-20 | trocar-trocar; 2,0 / 80mm |
| 212-523-22 | trocar-trocar; 2,2 / 80mm |
| 212-523-25 | trocar-trocar; 2,5 / 80mm |
| 212-523-30 | trocar-trocar; 3,0 / 80mm |
| 212-524-07 | trocar-trocar; 0,7 / 120mm |
| 212-524-09 | trocar-trocar; 0,9 / 120mm |
| 212-524-17 | trocar-trocar; 1,7 / 120mm |
| 212-524-30 | trocar-trocar; 3,0 / 120mm |
| 212-525-06 | trocar-trocar; 0,6 / 140mm |
| 212-525-07 | trocar-trocar; 0,7 / 140mm |
| 212-525-09 | trocar-trocar; 0,9 / 140mm |
| 212-525-17 | trocar-trocar; 1,7 / 140mm |
| 212-525-22 | trocar-trocar; 2,2 / 140mm |
| 212-525-30 | trocar-trocar; 3,0 / 140mm |
| 212-526-06 | trocar-trocar; 0,6 / 160mm |
| 212-526-07 | trocar-trocar; 0,7 / 160mm |
| 212-526-08 | trocar-trocar; 0,8 / 160mm |
| 212-526-09 | trocar-trocar; 0,9 / 160mm |
| 212-526-13 | trocar-trocar; 1,3 / 160mm |
| 212-526-17 | trocar-trocar; 1,7 / 160mm |
| 212-526-30 | trocar-trocar; 3,0 / 160mm |
| 212-527-06 | trocar-trocar; 0,6 / 230mm |
| 212-527-07 | trocar-trocar; 0,7 / 230mm |
| 212-527-08 | trocar-trocar; 0,8 / 230mm |
| 212-527-09 | trocar-trocar; 0,9 / 230mm |
| 212-527-10 | trocar-trocar; 1,0 / 230mm |
| 212-527-12 | trocar-trocar; 1,2 / 230mm |
| 212-527-14 | trocar-trocar; 1,4 / 230mm |
| 212-527-15 | trocar-trocar; 1,5 / 230mm |
| 212-527-16 | trocar-trocar; 1,6 / 230mm |
| 212-527-17 | trocar-trocar; 1,7 / 230mm |
| 212-527-18 | trocar-trocar; 1,8 / 230mm |
| 212-527-20 | trocar-trocar; 2,0 / 230mm |
| 212-527-22 | trocar-trocar; 2,2 / 230mm |
| 212-527-30 | trocar-trocar; 3,0 / 230mm |
| 212-528-06 | trocar-trocar; 0,6 / 310mm |
| 212-528-07 | trocar-trocar; 0,7 / 310mm |
| 212-528-08 | trocar-trocar; 0,8 / 310mm |
| 212-528-09 | trocar-trocar ; 0,9 / 310mm |
| 212-528-17 | trocar-trocar ; 1,7 / 310mm |
| 212-528-30 | trocar-trocar; 3,0 / 310mm |
| 212-531-06 | trocar-trocar; 0,6 / 60mm |
| 212-531-07 | trocar-lancet; 0,7 / 60mm |
| 212-531-08 | trocar-lancet; 0,8 / 60mm |
| 212-531-09 | trocar-lancet; 0,9 / 60mm |
| 212-531-10 | trocar-lancet; 1,0 / 60mm |
| 212-531-12 | trocar-lancet; 1,2 / 60mm |

Weitere Artikel
 further items
 más artículos

Art.Nr.	Beschreibung Description	Size	Spez.
---------	----------------------------	------	-------

Other items available but not illustrated

	KIRSCHNER wire drills; box with 10 pieces		
212-531-14	trocar-lancet; 1,4 / 60mm		
212-531-15	trocar-lancett; 1,5 / 60mm		
212-531-16	trocar-lancet; 1,6 / 60mm		
212-531-17	trocar-lancet; 1,7 / 60mm		
212-531-18	trocar-lancet; 1,8 / 60mm		
212-531-20	trocar-lancet; 2,0 / 60mm		
212-531-22	trocar-lancet; 2,2 / 60mm		
212-531-25	trocar-lancet; 2,5 / 60mm		
212-531-30	trocar-lancet; 3,0 / 60mm		
212-532-06	trocar-lancet; 0,6 / 70mm		
212-532-07	trocar-lancet; 0,7 / 70mm		
212-532-08	trocar-lancet; 0,8 / 70mm		
212-532-09	trocar-lancet; 0,9 / 70mm		
212-532-10	trocar-lancet; 1,0 / 70mm		
212-532-12	trocar-lancet; 1,2 / 70mm		
212-532-14	trocar-lancet; 1,4 / 70mm		
212-532-15	trocar-lancet; 1,5 / 70mm		
212-532-16	trocar-lancet; 1,6 / 70mm		
212-532-17	trocar-lancet; 1,7 / 70mm		
212-532-18	trocar-lancet; 1,8 / 70mm		
212-532-20	trocar-lancet; 2,0 / 70mm		
212-532-22	trocar-lancet; 2,2 / 70mm		
212-532-25	trocar-lancet; 2,5 / 70mm		
212-532-30	trocar-lancet; 3,0 / 70mm		
212-533-06	trocar-lancet; 0,6 / 80mm		
212-533-07	trocar-lancet; 0,7 / 80mm		
212-533-08	trocar-lancet; 0,8 / 80mm		
212-533-09	trocar-lancet; 0,9 / 80mm		
212-533-10	trocar-lancet; 1,0 / 80mm		
212-533-12	trocar-lancet; 1,2 / 80mm		
212-533-14	trocar-lancet; 1,4 / 80mm		
212-533-15	trocar-lancet; 1,5 / 80mm		
212-533-16	trocar-lancet; 1,6 / 80mm		
212-533-17	trocar-lancet; 1,7 / 80mm		
212-533-18	trocar-lancet; 1,8 / 80mm		
212-533-20	trocar-lancet; 2,0 / 80mm		
212-533-22	trocar-lancet 2,2 / 80mm		
212-533-25	trocar-lancet; 2,5 / 80mm		
212-533-30	trocar-lancet; 3,0 / 80mm		
212-534-06	trocar-lancet; 0,6 / 120mm		
212-534-07	trocar-lancet; 0,7 / 120mm		
212-534-08	trocar-lancet; 0,8 / 120mm		
212-534-09	trocar-lancet; 0,9 / 120mm		
212-534-10	trocar-lancet ; 1,0 / 120mm		
212-534-12	trocar-lancet; 1,2 / 120mm		
212-534-14	trocar-lancet; 1,4 / 120mm		
212-534-15	trocar-lancet; 1,5 / 120mm		
212-534-16	trocar-lancet; 1,6 / 120mm		
212-534-17	trocar-lancet; 1,7 / 120mm		
212-534-18	trocar-lancet; 1,8 / 120mm		

Weitere Artikel
further items
más artículos

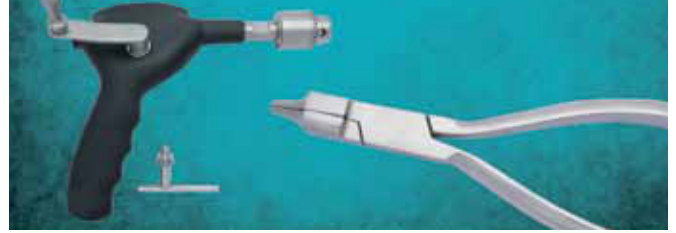

Art.Nr.	Beschreibung Description	Size	Spez.
---------	----------------------------	------	-------

Other items available but not illustrated

KIRSCHNER wire drills; box with 10 pieces

212-534-20	trocar-lancet; 2,0 / 120mm
212-534-22	trocar-lancet; 2,2 / 120mm
212-534-25	trocar-lancet; 2,5 / 120mm
212-534-30	trocar-lancet; 3,0 / 120mm
212-535-06	trocar-lancet; 0,6 / 140mm
212-535-07	trocar-lancet; 0,7 / 140mm
212-535-08	trocar-lancet; 0,8 / 140mm
212-535-09	trocar-lancet; 0,9 / 140mm
212-535-10	trocar-lancet; 1,0 / 140mm
212-535-12	trocar-lancet; 1,2 / 140mm
212-535-14	trocar-lancet; 1,4 / 140mm
212-535-15	trocar-lancet; 1,5 / 140mm
212-535-16	trocar-lancet; 1,6 / 140mm
212-535-17	trocar-lancet; 1,7 / 140mm
212-535-18	trocar-lancet; 1,8 / 140mm
212-535-20	trocar-lancet; 2,0 / 140mm
212-535-22	trocar-lancet; 2,2 / 140mm
212-535-25	trocar-lancet; 2,5 / 140mm
212-535-30	trocar-lancet; 3,0 / 140mm
212-536-06	trocar-lancet; 0,6 / 160mm
212-536-07	trocar-lancet; 0,7 / 160mm
212-536-08	trocar-lancet ; 0,8 / 160mm
212-536-09	trocar-lancet; 0,9 / 160mm
212-536-10	trocar-lancet; 1,0 / 160mm
212-536-12	trocar-lancet; 1,2 / 160mm
212-536-14	trocar-lancet; 1,4 / 160mm
212-536-15	trocar-lancet; 1,5 / 160mm
212-536-16	trocar-lancet; 1,6 / 160mm
212-536-17	trocar-lancet; 1,7 / 160mm
212-536-18	trocar-lancet; 1,8 / 160mm
212-536-20	trocar-lancet; 2,0 / 160mm
212-536-22	trocar-lancet; 2,2 / 160mm
212-536-25	trocar-lancet; 2,5 / 160mm
212-536-30	trocar-lancet; 3,0 / 160mm
212-537-06	trocar-lancet; 0,6 / 230mm
212-537-07	trocar-lancet; 0,7 / 230mm
212-537-08	trocar-lancet; 0,8 / 230mm
212-537-09	trocar-lancet; 0,9 / 230mm
212-537-10	trocar-lancet; 1,0 / 230mm
212-537-12	trocar-lancet; 1,2 / 230mm
212-537-14	trocar-lancet; 1,4 / 230mm
212-537-15	trocar-lancet; 1,5 / 230mm
212-537-16	trocar-lancet; 1,6 / 230mm
212-537-17	trocar-lancet; 1,7 / 230mm
212-537-18	trocar-lancet; 1,8 / 230mm
212-537-20	trocar-lancet; 2,0 / 230mm
212-537-22	trocar-lancet; 2,2 / 230mm
212-537-25	trocar-lancet; 2,5 / 230mm
212-537-30	trocar-lancet; 3,0 / 230mm
212-538-06	trocar-lancet; 0,6 / 310mm

Weitere Artikel
 further items
 más artículos

Art.Nr.	Beschreibung Description	Size	Spez.
---------	----------------------------	------	-------

Other items available but not illustrated

	KIRSCHNER wire drills; box with 10 pieces		
212-538-07	trocar-lancet; 0,7 / 310mm		
212-538-08	trocar-lancet; 0,8 / 310mm		
212-538-09	trocar-lancet; 0,9 / 310mm		
212-538-10	trocar-lancet; 1,0 / 310mm		
212-538-12	trocar-lancet; 1,2 / 310mm		
212-538-14	trocar-lancet; 1,4 / 310mm		
212-538-15	trocar-lancet; 1,5 / 310mm		
212-538-16	trocar-lancet; 1,6 / 310mm		
212-538-17	trocar-lancet; 1,7 / 310mm		
212-538-18	trocar-lancet; 1,8 / 310mm		
212-538-20	trocar-lancet; 2,0 / 310mm		
212-538-22	trocar-lancet; 2,2 / 310mm		
212-538-25	trocar-lancet; 2,5 / 310mm		
212-538-30	trocar-lancet; 3,0 / 310mm		
212-551-06	lancet-round; 0,6 / 60mm		
212-551-07	lancet-round; 0,7 / 60mm		
212-551-08	lancet-round; 0,8 / 60mm		
212-551-09	lancet-round; 0,9 / 60mm		
212-551-10	lancet-round; 1,0 / 60mm		
212-551-12	lancet-round; 1,2 / 60mm		
212-551-14	lancet-round; 1,4 / 60mm		
212-551-15	lancet-round; 1,5 / 60mm		
212-551-16	lancet-round; 1,6 / 60mm		
212-551-17	lancet-round; 1,7 / 60mm		
212-551-18	lancet-round; 1,8 / 60mm		
212-551-20	lancet-round; 2,0 / 60mm		
212-551-22	lancet-round; 2,2 / 60mm		
212-551-25	lancet-round; 2,5 / 60mm		
212-551-30	lancet-round; 3,0 / 60mm		
212-552-06	lancet-round; 0,6 / 70mm		
212-552-07	lancet-round; 0,7 / 70mm		
212-552-08	lancet-round; 0,8 / 70mm		
212-552-09	lancet-round; 0,9 / 70mm		
212-552-10	lancet-round; 1,0 / 70mm		
212-552-12	lancet-round; 1,2 / 70mm		
212-552-14	lancet-round; 1,4 / 70mm		
212-552-15	lancet-round; 1,5 / 70mm		
212-552-16	lancet-round; 1,6 / 70mm		
212-552-17	lancet-round; 1,7 / 70mm		
212-552-18	lancet-round; 1,8 / 70mm		
212-552-20	lancet-round; 2,0 / 70mm		
212-552-22	lancet-round; 2,2 / 70mm		
212-552-25	lancet-round; 2,5 / 70mm		
212-552-30	lancet-round; 3,0 / 70mm		
212-553-06	lancet-round; 0,6 / 80mm		
212-553-07	lancet-round; 0,7 / 80mm		
212-553-08	lancet-round; 0,8 / 80mm		
212-553-09	lancet-round; 0,9 / 80mm		
212-553-10	lancet-round; 1,0 / 80mm		
212-553-12	lancet-round; 1,2 / 80mm		

Weitere Artikel
further items
más artículos

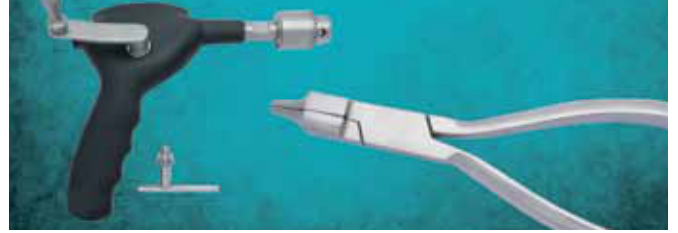

Art.Nr.	Beschreibung Description	Size	Spez.
---------	----------------------------	------	-------

Other items available but not illustrated

KIRSCHNER wire drills; box with 10 pieces

- 212-553-14 lancet-round; 1,4 / 80mm
- 212-553-15 lancet-round; 1,5 / 80mm
- 212-553-16 lancet-round; 1,6 / 80mm
- 212-553-17 lancet-round; 1,7 / 80mm
- 212-553-18 lancet-round; 1,8 / 80mm
- 212-553-20 lancet-round; 2,0 / 80mm
- 212-553-22 lancet-round; 2,2 / 80mm
- 212-553-25 lancet-round; 2,5 / 80mm
- 212-553-30 lancet-round; 3,0 / 80mm
- 212-554-06 lancet-round; 0,6 / 120mm
- 212-554-07 lancet-round; 0,7 / 120mm
- 212-554-08 lancet-round; 0,8 / 120mm
- 212-554-09 lancet-round; 0,9 / 120mm
- 212-554-10 lancet-round; 1,0 / 120mm
- 212-554-12 lancet-round; 1,2 / 120mm
- 212-554-14 lancet-round; 1,4 / 120mm
- 212-554-15 lancet-round; 1,5 / 120mm
- 212-554-16 lancet-round; 1,6 / 120mm
- 212-554-17 lancet-round; 1,7 / 120mm
- 212-554-18 lancet-round; 1,8 / 120mm
- 212-554-20 lancet-round; 2,0 / 120mm
- 212-554-22 lancet-round; 2,2 / 120mm
- 212-554-25 lancet-round; 2,5 / 120mm
- 212-554-30 lancet-round; 3,0 / 120mm
- 212-555-06 lancet-round; 0,6 / 140mm
- 212-555-07 lancet-round; 0,7 / 140mm
- 212-555-08 lancet-round; 0,8 / 140mm
- 212-555-09 lancet-round; 0,9 / 140mm
- 212-555-10 lancet-round; 1,0 / 140mm
- 212-555-12 lancet-round; 1,2 / 140mm
- 212-555-14 lancet-round; 1,4 / 140mm
- 212-555-15 lancet-round; 1,5 / 140mm
- 212-555-16 lancet-round; 1,6 / 140mm
- 212-555-17 lancet-round; 1,7 / 140mm
- 212-555-18 lancet-round; 1,8 / 140mm
- 212-555-20 lancet-round; 2,0 / 140mm
- 212-555-22 lancet-round; 2,2 / 140mm
- 212-555-25 lancet-round; 2,5 / 140mm
- 212-555-30 lancet-round; 3,0 / 140mm
- 212-556-06 lancet-round; 0,6 / 160mm
- 212-556-07 lancet-round; 0,7 / 160mm
- 212-556-08 lancet-round; 0,8 / 160mm
- 212-556-09 lancet-round; 0,9 / 160mm
- 212-556-10 lancet-round; 1,0 / 160mm
- 212-556-12 lancet-round; 1,2 / 160mm
- 212-556-14 lancet-round; 1,4 / 160mm
- 212-556-15 lancet-round; 1,5 / 160mm
- 212-556-16 lancet-round; 1,6 / 160mm
- 212-556-17 lancet-round; 1,7 / 160mm
- 212-556-18 lancet-round; 1,8 / 160mm

Weitere Artikel
 further items
 más artículos

Art.Nr.	Beschreibung Description	Size	Spez.
---------	----------------------------	------	-------

Other items available but not illustrated

	KIRSCHNER wire drills; box with 10 pieces		
212-556-20	lancet-round; 2,0 / 160mm		
212-556-22	lancet-round; 2,2 / 160mm		
212-556-25	lancet-round; 2,5 / 160mm		
212-556-30	lancet-round; 3,0 / 160mm		
212-557-06	lancet-round; 0,6 / 230mm		
212-557-07	lancet-round; 0,7 / 230mm		
212-557-08	lancet-round; 0,8 / 230mm		
212-557-09	lancet-round; 0,9 / 230mm		
212-557-10	lancet-round; 1,0 / 230mm		
212-557-12	lancet-round; 1,2 / 230mm		
212-557-14	lancet-round; 1,4 / 230mm		
212-557-15	lancet-round; 1,5 / 230mm		
212-557-16	lancet-round; 1,6 / 230mm		
212-557-17	lancet-round; 1,7 / 230mm		
212-557-18	lancet-round; 1,8 / 230mm		
212-557-20	lancet-round; 2,0 / 230mm		
212-557-22	lancet-round; 2,2 / 230mm		
212-557-25	lancet-round; 2,5 / 230mm		
212-557-30	lancet-round; 3,0 / 230mm		
212-558-06	lancet-round; 0,6 / 310mm		
212-558-07	lancet-round; 0,7 / 310mm		
212-558-08	lancet-round; 0,8 / 310mm		
212-558-09	lancet-round; 0,9 / 310mm		
212-558-10	lancet-round; 1,0 / 310mm		
212-558-12	lancet-round; 1,2 / 310mm		
212-558-14	lancet-round; 1,4 / 310mm		
212-558-15	lancet-round; 1,5 / 310mm		
212-558-16	lancet-round; 1,6 / 310mm		
212-558-17	lancet-round; 1,7 / 310mm		
212-558-18	lancet-round; 1,8 / 310mm		
212-558-20	lancet-round; 2,0 / 310mm		
212-558-22	lancet-round; 2,2 / 310mm		
212-558-25	lancet-round; 2,5 / 310mm		
212-558-30	lancet-round; 3,0 / 310mm		
212-561-06	lancet-flat; 0,6 / 60mm		
212-561-07	lancet-flat; 0,7 / 60mm		
212-561-08	lancet-flat; 0,8 / 60mm		
212-561-09	lancet-flat; 0,9 / 60mm		
212-561-10	lancet-flat; 1,0 / 60mm		
212-561-12	lancet-flat; 1,2 / 60mm		
212-561-14	lancet-flat; 1,4 / 60mm		
212-561-15	lancet-flat; 1,5 / 60mm		
212-561-16	lancet-flat; 1,6 / 60mm		
212-561-17	lancet-flat; 1,7 / 60mm		
212-561-18	lancet-flat; 1,8 / 60mm		
212-561-20	lancet-flat; 2,0 / 60mm		
212-561-22	lancet-flat; 2,2 / 60mm		
212-561-25	lancet-flat; 2,5 / 60mm		
212-561-30	lancet-flat; 3,0 / 60mm		
212-562-06	lancet-flat; 0,6 / 70mm		

Weitere Artikel
further items
más artículos

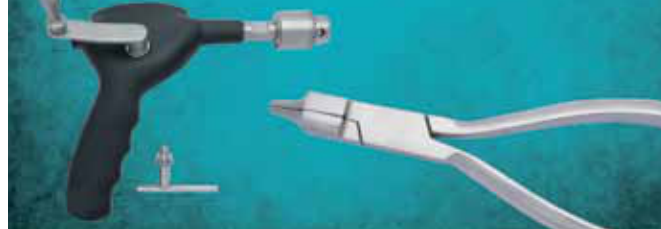

Art.Nr.	Beschreibung Description	Size	Spez.
---------	----------------------------	------	-------

Other items available but not illustrated

KIRSCHNER wire drills; box with 10 pieces

- | | |
|------------|--------------------------|
| 212-562-07 | lancet-flat; 0,7 / 70mm |
| 212-562-08 | lancet-flat; 0,8 / 70mm |
| 212-562-09 | lancet-flat; 0,9 / 70mm |
| 212-562-10 | lancet-flat; 1,0 / 70mm |
| 212-562-12 | lancet-flat; 1,2 / 70mm |
| 212-562-14 | lancet-flat; 1,4 / 70mm |
| 212-562-15 | lancet-flat; 1,5 / 70mm |
| 212-562-16 | lancet-flat; 1,6 / 70mm |
| 212-562-17 | lancet-flat; 1,7 / 70mm |
| 212-562-18 | lancet-flat; 1,8 / 70mm |
| 212-562-20 | lancet-flat; 2,0 / 70mm |
| 212-562-22 | lancet-flat; 2,2 / 70mm |
| 212-562-25 | lancet-flat; 2,5 / 70mm |
| 212-562-30 | lancet-flat; 3,0 / 70mm |
| 212-563-06 | lancet-flat; 0,6 / 80mm |
| 212-563-07 | lancet-flat; 0,7 / 80mm |
| 212-563-08 | lancet-flat; 0,8 / 80mm |
| 212-563-09 | lancet-flat; 0,9 / 80mm |
| 212-563-10 | lancet-flat; 1,0 / 80mm |
| 212-563-12 | lancet-flat; 1,2 / 80mm |
| 212-563-14 | lancet-flat; 1,4 / 80mm |
| 212-563-15 | lancet-flat; 1,5 / 80mm |
| 212-563-16 | lancet-flat; 1,6 / 80mm |
| 212-563-17 | lancet-flat; 1,7 / 80mm |
| 212-563-18 | lancet-flat; 1,8 / 80mm |
| 212-563-20 | lancet-flat; 2,0 / 80mm |
| 212-563-22 | lancet-flat; 2,2 / 80mm |
| 212-563-25 | lancet-flat; 2,5 / 80mm |
| 212-563-30 | lancet-flat; 3,0 / 80mm |
| 212-564-06 | lancet-flat; 0,6 / 120mm |
| 212-564-07 | lancet-flat; 0,7 / 120mm |
| 212-564-08 | lancet-flat; 0,8 / 120mm |
| 212-564-09 | lancet-flat; 0,9 / 120mm |
| 212-564-10 | lancet-flat; 1,0 / 120mm |
| 212-564-12 | lancet-flat; 1,2 / 120mm |
| 212-564-14 | lancet-flat; 1,4 / 120mm |
| 212-564-15 | lancet-flat; 1,5 / 120mm |
| 212-564-16 | lancet-flat; 1,6 / 120mm |
| 212-564-17 | lancet-flat; 1,7 / 120mm |
| 212-564-18 | lancet-flat; 1,8 / 120mm |
| 212-564-20 | lancet-flat; 2,0 / 120mm |
| 212-564-22 | lancet-flat; 2,2 / 120mm |
| 212-564-25 | lancet-flat; 2,5 / 120mm |
| 212-564-30 | lancet-flat; 3,0 / 120mm |
| 212-565-06 | lancet-flat; 0,6 / 140mm |
| 212-565-07 | lancet-flat; 0,7 / 140mm |
| 212-565-08 | lancet-flat; 0,8 / 140mm |
| 212-565-09 | lancet-flat; 0,9 / 140mm |
| 212-565-10 | lancet-flat; 1,0 / 140mm |
| 212-565-12 | lancet-flat; 1,2 / 140mm |

190

Weitere Artikel
further items
más artículos

Art.Nr. Beschreibung | Description Size Spez.

Other items available but not illustrated

Art.Nr.	Beschreibung Description	Size	Spez.
	KIRSCHNER wire drills; box with 10 pieces		
212-565-14	lancet-flat; 1,4 / 140mm		
212-565-15	lancet-flat; 1,5 / 140mm		
212-565-16	lancet-flat; 1,6 / 140mm		
212-565-17	lancet-flat; 1,7 / 140mm		
212-565-18	lancet-flat; 1,8 / 140mm		
212-565-20	lancet-flat; 2,0 / 140mm		
212-565-22	lancet-flat; 2,2 / 140mm		
212-565-25	lancet-flat; 2,5 / 140mm		
212-565-30	lancet-flat; 3,0 / 140mm		
212-566-06	lancet-flat; 0,6 / 160mm		
212-566-07	lancet-flat; 0,7 / 160mm		
212-566-08	lancet-flat; 0,8 / 160mm		
212-566-09	lancet-flat; 0,9 / 160mm		
212-566-10	lancet-flat; 1,0 / 160mm		
212-566-12	lancet-flat; 1,2 / 160mm		
212-566-14	lancet-flat; 1,4 / 160mm		
212-566-15	lancet-flat; 1,5 / 160mm		
212-566-16	lancet-flat; 1,6 / 160mm		
212-566-17	lancet-flat; 1,7 / 160mm		
212-566-18	lancet-flat; 1,8 / 160mm		
212-566-20	lancet-flat; 2,0 / 160mm		
212-566-22	lancet-flat; 2,2 / 160mm		
212-566-25	lancet-flat; 2,5 / 160mm		
212-566-30	lancet-flat; 3,0 / 160mm		
212-567-06	lancet-flat; 0,6 / 230mm		
212-567-07	lancet-flat; 0,7 / 230mm		
212-567-08	lancet-flat; 0,8 / 230mm		
212-567-09	lancet-flat; 0,9 / 230mm		
212-567-10	lancet-flat; 1,0 / 230mm		
212-567-12	lancet-flat; 1,2 / 230mm		
212-567-14	lancet-flat; 1,4 / 230mm		
212-567-15	lancet-flat; 1,5 / 230mm		
212-567-16	lancet-flat; 1,6 / 230mm		
212-567-17	lancet-flat; 1,7 / 230mm		
212-567-18	lancet-flat; 1,8 / 230mm		
212-567-20	lancet-flat; 2,0 / 230mm		
212-567-22	lancet-flat; 2,2 / 230mm		
212-567-25	lancet-flat; 2,5 / 230mm		
212-567-30	lancet-flat; 3,0 / 230mm		
212-568-06	lancet-flat; 0,6 / 310mm		
212-568-07	lancet-flat; 0,7 / 310mm		
212-568-08	lancet-flat; 0,8 / 310mm		
212-568-09	lancet-flat; 0,9 / 310mm		
212-568-10	lancet-flat; 1,0 / 310mm		
212-568-12	lancet-flat; 1,2 / 310mm		
212-568-14	lancet-flat; 1,4 / 310mm		
212-568-15	lancet-flat; 1,5 / 310mm		
212-568-16	lancet-flat; 1,6 / 310mm		
212-568-17	lancet-flat; 1,7 / 310mm		
212-568-18	lancet-flat; 1,8 / 310mm		

Weitere Artikel
further items
más artículos

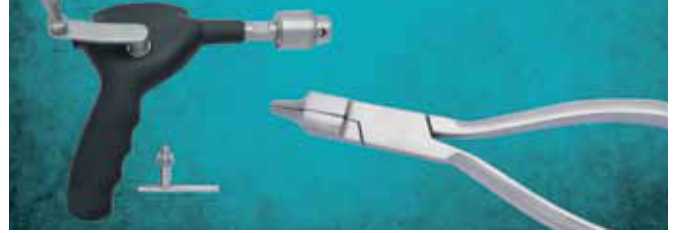

Art.Nr.	Beschreibung Description	Size	Spez.
---------	----------------------------	------	-------

Other items available but not illustrated

KIRSCHNER wire drills; box with 10 pieces

212-568-20	lancet-flat; 2,0 / 310mm
212-568-22	lancet-flat; 2,2 / 310mm
212-568-25	lancet-flat; 2,5 / 310mm
212-568-30	lancet-flat; 3,0 / 310mm
212-571-06	lancet-lancet; 0,6 / 60mm
212-571-07	lancet-lancet; 0,7 / 60mm
212-571-08	lancet-lancet; 0,8 / 60mm
212-571-09	lancet-lancet; 0,9 / 60mm
212-571-10	lancet-lancet; 1,0 / 60mm
212-571-12	lancet-lancet; 1,2 / 60mm
212-571-14	lancet-lancet; 1,4 / 60mm
212-571-15	lancet-lancet; 1,5 / 60mm
212-571-16	lancet-lancet; 1,6 / 60mm
212-571-17	lancet-lancet; 1,7 / 60mm
212-571-18	lancet-lancet; 1,8 / 60mm
212-571-20	lancet-lancet; 2,0 / 60mm
212-571-22	lancet-lancet; 2,2 / 60mm
212-571-25	lancet-lancet; 2,5 / 60mm
212-571-30	lancet-lancet; 3,0 / 60mm
212-572-06	lancet-lancet; 0,6 / 70mm
212-572-07	lancet-lancet; 0,7 / 70mm
212-572-08	lancet-lancet; 0,8 / 70mm
212-572-09	lancet-lancet; 0,9 / 70mm
212-572-10	lancet-lancet; 1,0 / 70mm
212-572-12	lancet-lancet; 1,2 / 70mm
212-572-14	lancet-lancet; 1,4 / 70mm
212-572-15	lancet-lancet; 1,5 / 70mm
212-572-16	lancet-lancet; 1,6 / 70mm
212-572-17	lancet-lancet; 1,7 / 70mm
212-572-18	lancet-lancet; 1,8 / 70mm
212-572-20	lancet-lancet; 2,0 / 70mm
212-572-22	lancet-lancet; 2,2 / 70mm
212-572-25	lancet-lancet; 2,5 / 70mm
212-572-30	lancet-lancet; 3,0 / 70mm
212-573-06	lancet-lancet; 0,6 / 80mm
212-573-07	lancet-lancet; 0,7 / 80mm
212-573-08	lancet-lancet; 0,8 / 80mm
212-573-09	lancet-lancet; 0,9 / 80mm
212-573-10	lancet-lancet; 1,0 / 80mm
212-573-12	lancet-lancet; 1,2 / 80mm
212-573-14	lancet-lancet; 1,4 / 80mm
212-573-15	lancet-lancet; 1,5 / 80mm
212-573-16	lancet-lancet; 1,6 / 80mm
212-573-17	lancet-lancet; 1,7 / 80mm
212-573-18	lancet-lancet; 1,8 / 80mm
212-573-20	lancet-lancet; 2,0 / 80mm
212-573-22	lancet-lancet; 2,2 / 80mm
212-573-25	lancet-lancet; 2,5 / 80mm
212-573-30	lancet-lancet; 3,0 / 80mm
212-574-06	lancet-lancet; 0,6 / 120mm

Weitere Artikel
 further items
 más artículos

Art.Nr.	Beschreibung Description	Size	Spez.
---------	----------------------------	------	-------

Other items available but not illustrated

	KIRSCHNER wire drills; box with 10 pieces		
212-574-07	lancet-lancet; 0,7 / 120mm		
212-574-08	lancet-lancet; 0,8 / 120mm		
212-574-09	lancet-lancet; 0,9 / 120mm		
212-574-10	lancet-lancet; 1,0 / 120mm		
212-574-12	lancet-lancet; 1,2 / 120mm		
212-574-14	lancet-lancet; 1,4 / 120mm		
212-574-15	lancet-lancet; 1,5 / 120mm		
212-574-16	lancet-lancet; 1,6 / 120mm		
212-574-17	lancet-lancet; 1,7 / 120mm		
212-574-18	lancet-lancet; 1,8 / 120mm		
212-574-20	lancet-lancet; 2,0 / 120mm		
212-574-22	lancet-lancet; 2,2 / 120mm		
212-574-25	lancet-lancet; 2,5 / 120mm		
212-574-30	lancet-lancet; 3,0 / 120mm		
212-575-06	lancet-lancet; 0,6 / 140mm		
212-575-07	lancet-lancet; 0,7 / 140mm		
212-575-08	lancet-lancet; 0,8 / 140mm		
212-575-09	lancet-lancet; 0,9 / 140mm		
212-575-10	lancet-lancet; 1,0 / 140mm		
212-575-12	lancet-lancet; 1,2 / 140mm		
212-575-14	lancet-lancet; 1,4 / 140mm		
212-575-15	lancet-lancet; 1,5 / 140mm		
212-575-16	lancet-lancet; 1,6 / 140mm		
212-575-17	lancet-lancet; 1,7 / 140mm		
212-575-18	lancet-lancet; 1,8 / 140mm		
212-575-20	lancet-lancet; 2,0 / 140mm		
212-575-22	lancet-lancet; 2,2 / 140mm		
212-575-25	lancet-lancet; 2,5 / 140mm		
212-575-30	lancet-lancet; 3,0 / 140mm		
212-576-06	lancet-lancet; 0,6 / 160mm		
212-576-07	lancet-lancet; 0,7 / 160mm		
212-576-08	lancet-lancet; 0,8 / 160mm		
212-576-09	lancet-lancet; 0,9 / 160mm		
212-576-10	lancet-lancet; 1,0 / 160mm		
212-576-12	lancet-lancet; 1,2 / 160mm		
212-576-14	lancet-lancet; 1,4 / 160mm		
212-576-15	lancet-lancet; 1,5 / 160mm		
212-576-16	lancet-lancet; 1,6 / 160mm		
212-576-17	lancet-lancet; 1,7 / 160mm		
212-576-18	lancet-lancet; 1,8 / 160mm		
212-576-20	lancet-lancet; 2,0 / 160mm		
212-576-22	lancet-lancet; 2,2 / 160mm		
212-576-25	lancet-lancet; 2,5 / 160mm		
212-576-30	lancet-lancet; 3,0 / 160mm		
212-577-06	lancet-lancet; 0,6 / 230mm		
212-577-07	lancet-lancet; 0,7 / 230mm		
212-577-08	lancet-lancet; 0,8 / 230mm		
212-577-09	lancet-lancet; 0,9 / 230mm		
212-577-10	lancet-lancet; 1,0 / 230mm		
212-577-12	lancet-lancet; 1,2 / 230mm		

Weitere Artikel
further items
más artículos

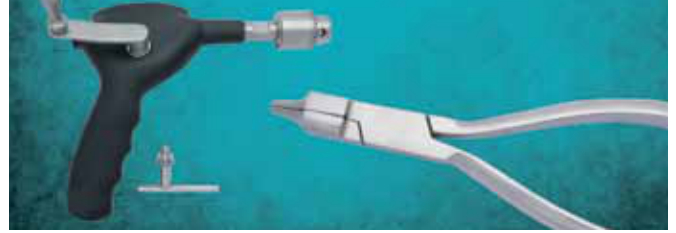

Art.Nr.	Beschreibung Description	Size	Spez.
Other items available but not illustrated			
KIRSCHNER wire drills; box with 10 pieces			
212-577-14	lancet-lancet; 1,4 / 230mm		
212-577-15	lancet-lancet; 1,5 / 230mm		
212-577-16	lancet-lancet; 1,6 / 230mm		
212-577-17	lancet-lancet; 1,7 / 230mm		
212-577-18	lancet-lancet; 1,8 / 230mm		
212-577-20	lancet-lancet; 2,0 / 230mm		
212-577-22	lancet-lancet; 2,2 / 230mm		
212-577-25	lancet-lancet; 2,5 / 230mm		
212-577-30	lancet-lancet; 3,0 / 230mm		
212-578-06	lancet-lancet; 0,6 / 310mm		
212-578-07	lancet-lancet; 0,7 / 310mm		
212-578-08	lancet-lancet; 0,8 / 310mm		
212-578-09	lancet-lancet; 0,9 / 310mm		
212-578-10	lancet-lancet; 1,0 / 310mm		
212-578-12	lancet-lancet; 1,2 / 310mm		
212-578-14	lancet-lancet; 1,4 / 310mm		
212-578-15	lancet-lancett; 1,5 / 310mm		
212-578-16	lancet-lancet; 1,6 / 310mm		
212-578-17	lancet-lancet; 1,7 / 310mm		
212-578-18	lancet-lancet; 1,8 / 310mm		
212-578-20	lancet-lancet; 2,0 / 310mm		
212-578-22	lancet-lancet; 2,2 / 310mm		
212-578-25	lancet-lancet; 2,5 / 310mm		
212-578-30	lancet-lancet; 3,0 / 310mm		
KIRSCHNER wire drill dispenser			
212-590-15		15,5cm; 6,2"	
212-590-19		19,0cm; 7,6"	
212-590-32		32,0cm; 12,6"	
wire drill dispenser			
212-591-08	for wire Ø 0,8mm	10,0cm; 4"	
212-591-10	for wire Ø 1,0mm		
212-591-12	for wire Ø 1,2mm		
212-591-14	for wire Ø 1,4mm		
212-591-15	for wire Ø 1,5mm		
212-591-16	for wire Ø 1,6mm		
212-591-18	for wire Ø 1,8mm		
212-591-20	for wire Ø 2,0mm		
212-591-22	for wire Ø 2,2mm		
212-591-25	for wire Ø 2,5mm		
212-591-30	for wire Ø 3,0mm		
wire drill dispenser			
212-592-08	for wire Ø 0,8mm	15,0cm; 6"	
212-592-10	for wire Ø 1,0mm		
212-592-12	for wire Ø 1,2mm		
212-592-14	for wire Ø 1,4mm		
212-592-15	for wire Ø 1,5mm		
212-592-16	for wire Ø 1,6mm		

Weitere Artikel
further items
más artículos

Art.Nr.	Beschreibung Description	Size	Spez.
Other items available but not illustrated			
	wire drill dispenser	15,0cm; 6"	
212-592-18	for wire Ø 1,8mm		
212-592-20	for wire Ø 2,0mm		
212-592-22	for wire Ø 2,2mm		
212-592-25	for wire Ø 2,5mm		
212-592-30	for wire Ø 3,0mm		
	wire drill dispenser	31,0cm; 12,4"	
212-594-08	for wire Ø 0,8mm		
212-594-10	for wire Ø 1,0mm		
212-594-12	for wire Ø 1,2mm		
212-594-14	for wire Ø 1,4mm		
212-594-15	for wire Ø 1,5mm		
212-594-16	for wire Ø 1,6mm		
212-594-18	for wire Ø 1,8mm		
212-594-20	for wire Ø 2,0mm		
212-594-22	for wire Ø 2,2mm		
212-594-25	for wire Ø 2,5mm		
212-594-30	for wire Ø 3,0mm		



hand drills

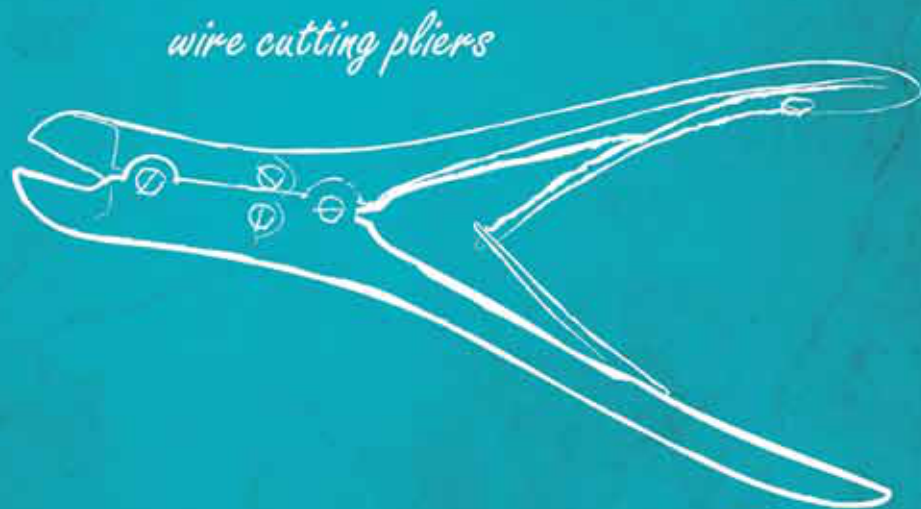

wire cutting pliers

Hämmer
Mallets

191

Hämmer
Mallets
Martillos

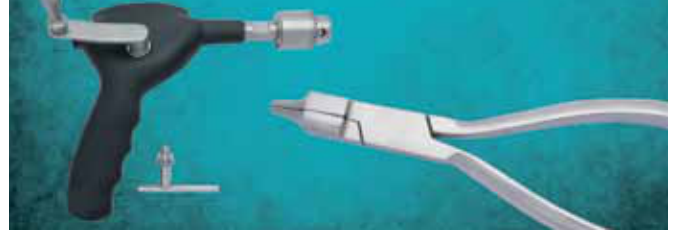

Art.Nr.	Beschreibung Description	Size	Spez.
	PARTSCH bleigefüllt lead filled relleno de plomo	19,0cm; 7 4/8"	



Kopf
head
cabeza

Gewicht
weight
peso

191-145-18 25 mm 200 g / 240 g

WILLIGER bleigefüllt
lead filled
relleno de plomo

24,0cm; 9 4/8"



Kopf
head
cabeza

Gewicht
weight
peso

191-210-24 26 mm 160 g / 320 g

191-210-28 28 mm 200 g / 360 g

191-210-30 30 mm 240 g / 380 g

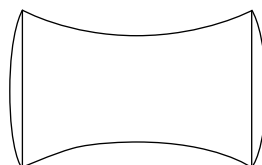

Hämmer
Mallets
Martillos

Art.Nr.	Beschreibung Description	Size	Spez.
---------	----------------------------	------	-------

DOYEN

21,0cm; 8 2/8"



Kopf
head
cabeza

Gewicht
weight
peso

191-212-25 25 mm 100 g / 120 g

191-212-30 30 mm 140 g / 180 g

191-212-35 35 mm 220 g / 240 g

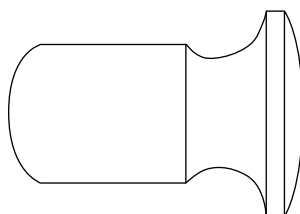

COTTLE plan/konvex
plane/convex
plano/convexo

19,0cm; 7 4/8"



Kopf
head
cabeza

Gewicht
weight
peso

191-216-19 30 mm 240 g / 300 g

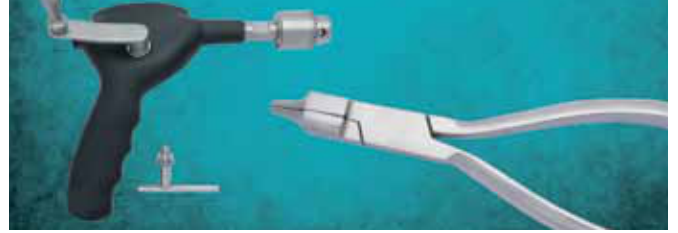

Art.Nr.	Beschreibung Description	Size	Spez.
	COLLIN	20,0cm; 7 7/8"	



Kopf
head
cabeza

Gewicht
weight
peso

191-220-20 30 mm 240 g / 260 g

WILLIGER

16,5cm; 6 4/8"



Kopf
head
cabeza

Gewicht
weight
peso

191-234-01 20 mm 100 g / 140 g bleigefüllt
lead filled | relleno de plomo

191-234-02 20 mm 70 g / 120 g massiv
solid | macizo

Hämmer
Mallets
Martillos

Art.Nr.	Beschreibung Description	Size	Spez.
	LUCAE	19,5cm; 7 5/8"	



Kopf
head
cabeza

Gewicht
weight
peso

191-236-19 19 mm 120 g / 200 g

191-236-26 26 mm 140 g / 240 g



Mit Kunststoffgriff
With plastic handle
Con mango de plástico

26,0cm; 10 2/8"



Kopf
head
cabeza

Gewicht
weight
peso

191-280-26 30 mm 300 g / 480 g

Hämmer mit Kunststoffgriff
 Mallets with plastic handle
 Martillos con mango de plástico



Art.Nr.	Beschreibung Description	Size	Spez.
---------	----------------------------	------	-------

plan/konvex
 plane/convex
 plano/convexo

26,0cm; 10 2/8"



Kopf
 head
 cabeza

Gewicht
 weight
 peso

191-282-26

32 mm

500 g / 700 g

26,0cm; 10 2/8"



Kopf
 head
 cabeza

Gewicht
 weight
 peso

191-283-26

29 / 45 mm

380 g / 560 g

191

Hämmer mit Kunststoffgriff
 Mallets with plastic handle
 Martillos con mango de plástico

Art.Nr.	Beschreibung Description	Size	Spez.
---------	----------------------------	------	-------

26,0cm; 10 2/8"



Kopf head cabeza	Gewicht weight peso
------------------------	---------------------------

191-284-24	30 mm	300 g / 500 g
------------	-------	---------------

26,0cm; 10 2/8"



Kopf head cabeza	Gewicht weight peso
------------------------	---------------------------

191-285-26	30 mm	560 g / 760 g
------------	-------	---------------

Hämmer mit Kunststoffgriff
 Mallets with plastic handle
 Martillos con mango de plástico

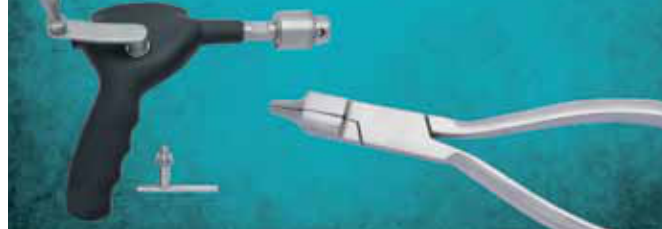

Art.Nr.	Beschreibung Description	Size	Spez.
		26,0cm; 10 2/8"	



Kopf head
 cabeza
 Gewicht weight
 peso

191-286-26	50 mm	1100 g / 1300 g g
------------	-------	-------------------

Backen auswechselbar
 facings interchangeable
 tapas intercambiables

19,0cm; 7 4/8"



Kopf head
 cabeza
 Gewicht weight
 peso

191-287-19	30 mm	230 g / 440 g
------------	-------	---------------

191

Hämmer mit Kunststoffgriff
 Mallets with plastic handle
 Martillos con mango de plástico

Art.Nr.	Beschreibung Description	Size	Spez.
	HERBERT für Ulnakopf-Prothese for ulnar head prothesis para prótesis de la cabeza ulna	19,0cm; 7 4/8"	



Kopf	Gewicht
head	weight
cabeza	peso

191-288-19	25 mm	220 g / 440 g
------------	-------	---------------

Ersatzbacken
 replacement jaws
 mordazas de repuesto

191-290-20	konvex convex convexe	Ø 20 mm
------------	-----------------------------	---------



191-291-32	plan plane plano	Ø 25 mm
------------	------------------------	---------



191-291-25	plan plane plano	Ø 32 mm
------------	------------------------	---------



Weitere Artikel
further items
más artículos

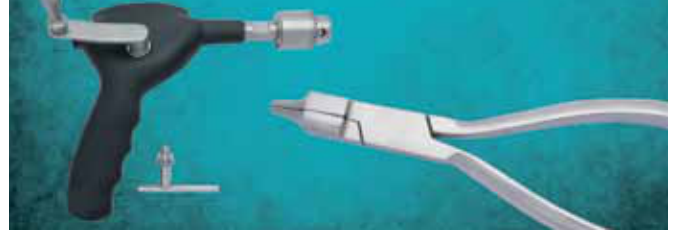

Art.Nr.	Beschreibung Description	Size	Spez.
Other items available but not illustrated			
191-132-20	COLLIN Mallet; Ø 30mm, 220g	20,0cm; 8"	
191-201-24	BERGMANN Mallet Ø 45mm, 300g	24,0cm; 9,6"	
191-205-23	Ø 30mm, 300g	23,0cm; 9,2"	
191-207-24	OMBREDANNE Mallet; Ø 40mm, 550g	24,0cm; 9,6"	
191-224-22	HAJEK Mallet; Ø 27mm, 140g	22,0cm; 8,8"	
191-226-19	GERZOG Mallet; lead filled, Ø 25mm		
191-226-21	HAJEK Mallet; Ø 20mm, 110g	21,5cm; 8,6"	
191-228-21	KIRK Mallet; Ø 40mm; 21cm; 680g		
191-230-02	plastic discs for mallet; for 191-230-18, 1 pair, price pro pair		
191-230-18	Mallet with plastic discs 140g	18,0cm; 7,2"	
191-232-25	Ø 30mm, 215g	25,0cm; 10"	
191-238-19	LUCAE Mallet; Ø 25mm, 260 G., 19.5cm	19,5cm; 7,8"	
191-240-02	ferrozell faces; for Mallet		
191-240-17	MEAD Mallet; 320g, with discs	17,0cm; 6,8"	
191-246-32	Mallet Ø 32mm, 390g	24,0cm; 9,6"	
191-246-35	Ø 35mm, 540g	24,0cm; 9,6"	
191-246-40	Ø 40mm, 740g	24,0cm; 9,6"	
191-248-45	450g, steel, Ø 30mm	26,5cm; 10,6"	
191-248-90	900g, steel, Ø 50mm	26,5cm; 10,6"	
191-250-24	530g, steel, Ø 42/30mm	24,0cm; 9,6"	
191-252-26	Ø 45mm, 250g	26,0cm; 10,4"	
191-254-35	Ø 35mm	25,0cm; 10"	
191-254-42	Ø 42mm	25,0cm; 10"	
191-254-50	Ø 50mm	25,0cm; 10"	
191-256-02	plastic discs for mallet		
191-256-22	MALLET with plastic discs; 370g		
191-258-18	Mallet ferrozell; 125g		
191-260-24	STEINBACH Mallet; 80x60mm	24,0cm; 9,6"	
191-262-23	Mallet; Ø 45mm, 290g	23,0cm; 9,2"	
191-264-18	HEATH Mallet; copper filled head, Ø 40,0mm	18,5cm; 7,4"	

Weitere Artikel
further items
más artículos

Art.Nr.	Beschreibung Description	Size	Spez.
Other items available but not illustrated			
191-266-01	WAGNER Mallet metal discs only		
191-266-02	plastic discs only		
191-266-10	wrench only		
191-266-24	Ø 35,0mm, with discs	24,5cm; 8,8"	
191-292-25	spare facings made of plastic; pair	Ø 30mm	



hand drills

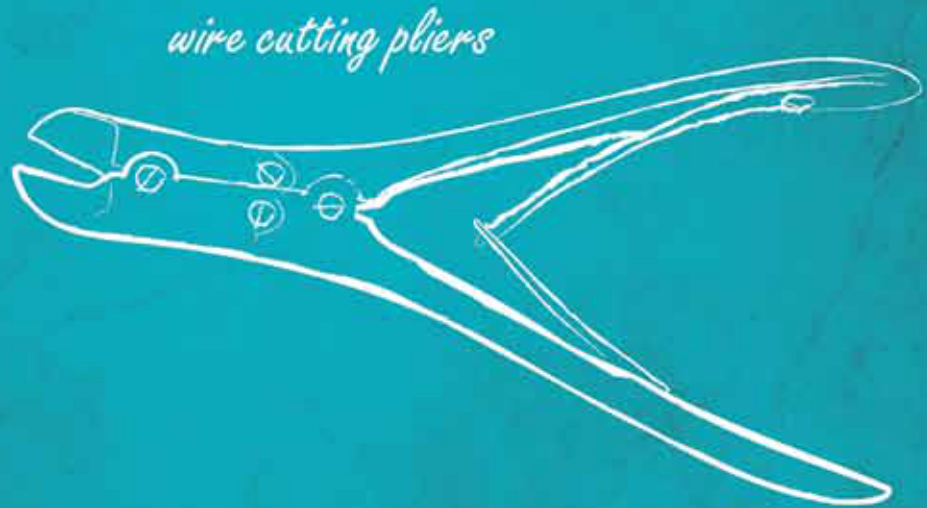

wire cutting pliers

192

Scharfe Löffel
 Bone Curettes
 Cucharillas Cortantes



Art.Nr.	Beschreibung Description	Size	Spez.
---------	----------------------------	------	-------

WILLIGER

14,0cm; 5 4/8"



192-406-00	Fig. 00/0	<input type="radio"/> <input type="radio"/>
192-406-01	Fig. 0/1	<input type="radio"/> <input type="radio"/>
192-406-02	Fig. 1/2	<input type="radio"/> <input type="radio"/>

WILLIGER

16,5cm; 6 4/8"



192-407-00	Fig. 00/0	<input type="radio"/> <input type="radio"/>
192-407-01	Fig. 0/1	<input type="radio"/> <input type="radio"/>
192-407-02	Fig. 1/2	<input type="radio"/> <input type="radio"/>

192-410-16	JANSEN	16,0cm; 6 2/8"
------------	--------	----------------



<input type="radio"/>	<input type="radio"/>
-----------------------	-----------------------

192-411-15	JANSEN	15,0cm; 5 7/8"
------------	--------	----------------



192

Scharfe Löffel
 Bone Curettes
 Cucharillas Cortantes

Art.Nr.	Beschreibung Description	Size	Spez.
---------	----------------------------	------	-------

VOLKMANN



192-414-13	12,5cm; 4 7/8"	
------------	----------------	--

192-414-14	14,5cm; 5 6/8"	
------------	----------------	--

192-414-17	17,0cm; 6 6/8"	
------------	----------------	--

VOLKMANN



192-415-13	13,0cm; 5 1/8"	
------------	----------------	--

192-415-16	16,0cm; 6 2/8"	
------------	----------------	--

192-415-20	20,0cm; 7 7/8"	
------------	----------------	--

192-418-21		21,0cm; 8 2/8"
------------	--	----------------



Scharfe Löffel
Bone Curettes
Cucharillas Cortantes

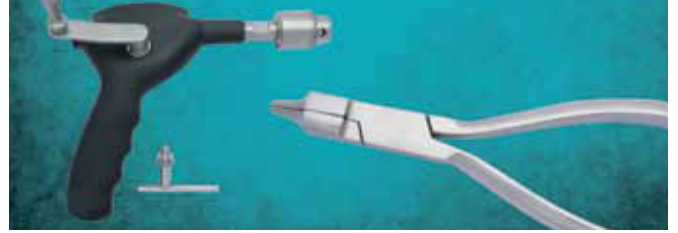

Art.Nr.	Beschreibung Description	Size	Spez.
	MODELL USA	16,0cm; 6 2/8"	



192-435-01	Fig. 1		192-435-04	Fig. 4	
192-435-02	Fig. 2		192-435-05	Fig. 5	
192-435-03	Fig. 3		192-435-06	Fig. 6	

	MODELL USA	16,0cm; 6 2/8"	
--	------------	----------------	--



192-436-01	Fig. 1		192-436-04	Fig. 4	
192-436-02	Fig. 2		192-436-05	Fig. 5	
192-436-03	Fig. 3		192-436-06	Fig. 6	

	MODELL USA	16,0cm; 6 2/8"	
--	------------	----------------	--



192-437-01	Fig. 1		192-437-04	Fig. 4	
192-437-02	Fig. 2		192-437-05	Fig. 5	
192-437-03	Fig. 3		192-437-06	Fig. 6	

192

Scharfe Löffel
 Bone Curettes
 Cucharillas Cortantes

Art.Nr.	Beschreibung Description	Size	Spez.
---------	----------------------------	------	-------

STILLE

19,5cm; 7 3/4"



192-440-02	Ø 2 mm		192-440-07	Ø 7 mm	
192-440-03	Ø 3 mm		192-440-08	Ø 8 mm	
192-440-04	Ø 4 mm		192-440-10	Ø 10 mm	
192-440-05	Ø 5 mm		192-440-12	Ø 12 mm	
192-440-06	Ø 6 mm		192-440-14	Ø 14 mm	

STILLE

19,5cm; 7 3/4"



192-442-02	Ø 2 mm		192-442-07	Ø 7 mm	
192-442-03	Ø 3 mm		192-442-08	Ø 8 mm	
192-442-04	Ø 4 mm		192-442-10	Ø 10 mm	
192-442-05	Ø 5 mm		192-442-12	Ø 12 mm	
192-442-06	Ø 6 mm		192-442-14	Ø 14 mm	

Scharfe Löffel
Bone Curettes
Cucharillas Cortantes

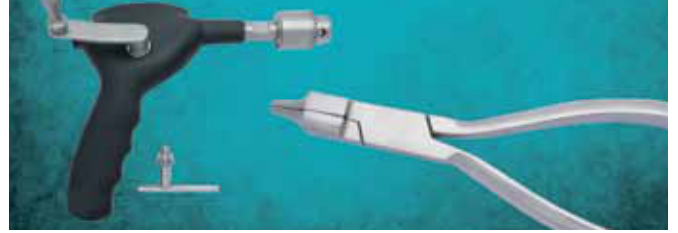

Art.Nr.	Beschreibung Description		Size	Spez.
	SIMON		24,0cm; 9 4/8"	
192-444-01	Fig. 1		192-444-04	Fig. 4
192-444-02	Fig. 2		192-444-05	Fig. 5
192-444-03	Fig. 3		192-444-06	Fig. 6
	LEMPERT		21,5cm; 8 4/8"	
192-448-00	Fig. 0 Ø 3,0 mm		192-448-03	Fig. 0000 Ø 2,2 mm
192-448-01	Fig. 00 Ø 2,7 mm		192-448-04	Fig. 00000 Ø 2,0 mm
192-448-02	Fig. 000 Ø 2,4 mm			
	HALLE biegsam flexible flexible		21,0cm; 8 2/8"	
192-452-02	Fig. 1		192-452-11	Fig. 3
192-452-01	Fig. 2			

192

Art.Nr.	Beschreibung Description	Size	Spez.
---------	----------------------------	------	-------

UFFENORDE

17,0cm; 6 6/8



192-455-01 links gebogen
 curved left
 curva a la izquierda

192-455-02 rechts gebogen
 curved right
 curva a la derecha

SCHEDE

17,0cm; 6 6/8"





192-467-01 Fig. 0 

192-467-12 Fig. 2 

192-467-02 Fig. 00 

192-467-13 Fig. 3 

192-467-03 Fig. 000 

192-467-14 Fig. 4 

192-467-11 Fig. 1 

Scharfe Löffel
 Bone Currettes
 Cucharillas Cortantes



Art.Nr.	Beschreibung Description	Size	Spez.
VOLKMANN		17,0cm; 6 6/8"	



192-469-01	Fig. 0		192-469-12	Fig. 2	
192-469-02	Fig. 00		192-469-13	Fig. 3	
192-469-03	Fig. 000		192-469-14	Fig. 4	
192-469-04	Fig. 0000		192-469-15	Fig. 5	
192-469-11	Fig. 1		192-469-16	Fig. 6	

BRUNS		17,0cm; 6 6/8"
-------	--	----------------



192-472-01	Fig. 0		192-472-12	Fig. 2	
192-472-02	Fig. 00		192-472-13	Fig. 3	
192-472-03	Fig. 000		192-472-14	Fig. 4	
192-472-04	Fig. 0000		192-472-15	Fig. 5	
192-472-11	Fig. 1		192-472-16	Fig. 6	

192

Scharfe Löffel
 Bone Curettes
 Cucharillas Cortantes

Art.Nr.	Beschreibung Description	Size	Spez.
	BRUNS	23,0cm; 9"	



192-473-01	Fig. 0		192-473-13	Fig. 3	
192-473-02	Fig. 00		192-473-14	Fig. 4	
192-473-03	Fig. 000		192-473-15	Fig. 5	
192-473-11	Fig. 1		192-473-16	Fig. 6	
192-473-12	Fig. 2				

SPRATT

17,0cm; 6 6/8"



192-475-01	Fig. 0		192-475-12	Fig. 2	
192-475-02	Fig. 00		192-475-13	Fig. 3	
192-475-03	Fig. 000		192-475-14	Fig. 4	
192-475-04	Fig. 0000		192-475-15	Fig. 5	
192-475-11	Fig. 1				

Scharfe Löffel
 Bone Curettes
 Cucharillas Cortantes



Art.Nr.	Beschreibung Description	Size	Spez.
	SPRATT (BRUNS)	23,0cm; 9"	



192-478-01	Fig. 0		192-478-13	Fig. 3	
192-478-02	Fig. 00		192-478-14	Fig. 4	
192-478-03	Fig. 000		192-478-15	Fig. 5	
192-478-11	Fig. 1		192-478-16	Fig. 6	
192-478-12	Fig. 2				

	SPRATT (BRUNS)	23,0cm; 9"
--	----------------	------------













192-479-01	Fig. 0		192-479-13	Fig. 3	
192-479-02	Fig. 00		192-479-14	Fig. 4	
192-479-03	Fig. 000		192-479-15	Fig. 5	
192-479-11	Fig. 1		192-479-16	Fig. 6	
192-479-12	Fig. 2				

192

Scharfe Löffel
Bone Curettes
Cucharillas Cortantes









Art.Nr.	Beschreibung Description	Size	Spez.
	VOLKMANN	17,0cm; 6 6/8"	FERROZELL

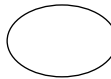

192-480-01	Fig. 1		192-480-06	Fig. 6	
192-480-02	Fig. 2		192-480-10	Fig. 0	
192-480-03	Fig. 3		192-480-20	Fig. 00	
192-480-04	Fig. 4		192-480-30	Fig. 000	
192-480-05	Fig. 5		192-480-40	Fig. 0000	

	VOLKMANN	27,0cm; 10 5/8"	FERROZELL
--	----------	-----------------	-----------



192-482-01	Fig. 1		192-482-06	Fig. 6	
192-482-02	Fig. 2		192-482-10	Fig. 0	
192-482-03	Fig. 3		192-482-20	Fig. 00	
192-482-04	Fig. 4		192-482-30	Fig. 000	
192-482-05	Fig. 5		192-482-40	Fig. 0000	

Scharfe Löffel
 Bone Curettes
 Cucharillas Cortantes

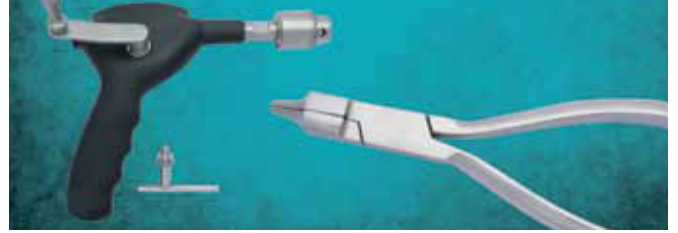

Art.Nr.	Beschreibung Description	Size	Spez.
---------	----------------------------	------	-------

25,0cm; 9 7/8"





192-483-00	3,0 mm 	192-483-02	5,0 mm 
------------	--	------------	--

192-483-01	4,0 mm 	192-483-03	6,0 mm 
------------	--	------------	--

25,0cm; 9 7/8"



192-484-00	Fig. 000 Ø 3,6 mm 	192-484-02	Fig. 0 Ø 5,2 mm 
------------	--	------------	--

192-484-01	Fig. 00 Ø 4,4 mm 	192-484-03	Fig. 1 Ø 6,0 mm 
------------	---	------------	--

25,0cm; 9 7/8"



192-485-00	Fig. 000 Ø 3,6 mm 	192-485-02	Fig. 0 Ø 5,2 mm 
------------	--	------------	--

192-485-01	Fig. 00 Ø 4,4 mm 	192-485-03	Fig. 1 Ø 6,0 mm 
------------	---	------------	--

192

Scharfe Löffel
 Bone Currettes
 Cucharillas Cortantes

Art.Nr.	Beschreibung Description	Size	Spez.
---------	----------------------------	------	-------

DAUBENSPECK

20,0cm; 7 7/8"



192-487-01	Fig. 0		192-487-11	Fig. 1	
------------	--------	---	------------	--------	---

192-487-02	Fig. 00		192-487-12	Fig. 2	
------------	---------	---	------------	--------	---

Löffel
Curettes
Cucharillas

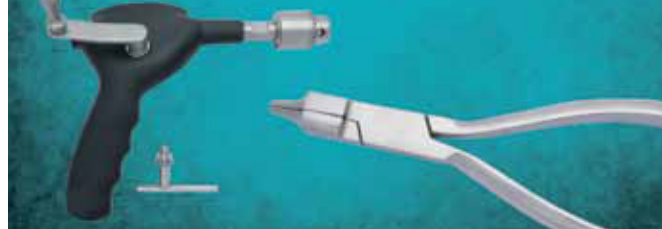

Art.Nr. Beschreibung | Description Size Spez.

Cervical Bayonet Curettes

21,5cm; 8 1/2"

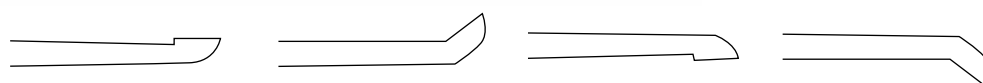

Shape	FS	FA	BS	BA
Cup 0	192-610-10	192-611-10	192-612-10	192-613-10
Cup 00	192-610-20	192-611-20	192-612-20	192-613-20
Cup 000	192-610-30	192-611-30	192-612-30	192-613-30
Cup 0000	192-610-40	192-611-40	192-612-40	192-613-40

Cervical Bayonet Bone Cutter

21,5cm; 8 1/2"



Shape	FS	FA	BS	BA
Cup 00	192-610-92	192-611-92	192-612-92	192-613-92

192-614-01 Cervical Bayonet Nerve Hook  21,5cm; 8 1/2"

192-614-02 Cervical Bayonet Ultra Nerve Hook  21,5cm; 8 1/2"

192-614-03 Cervical Bayonet Bone Waxer  21,5cm; 8 1/2"

192-614-99 Cervical Bayonet Knife Handle 21,5cm; 8 1/2"

	0	0	0	0	0	0
Cup Size	2	1	0	00	000	0000
mm	4.5 x 7.5	3.5 x 6.0	3.0 x 5.0	2.5 x 4.0	2.0 x 3.3	1.7 x 2.7





Art.Nr.	Beschreibung Description	Size	Spez.
	Large Cervical Bayonet Curettes	24,0cm; 9 1/2"	

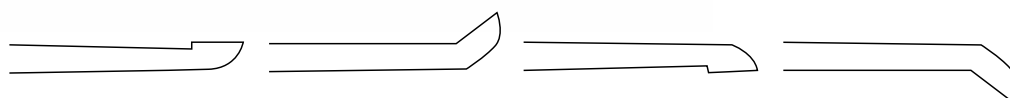

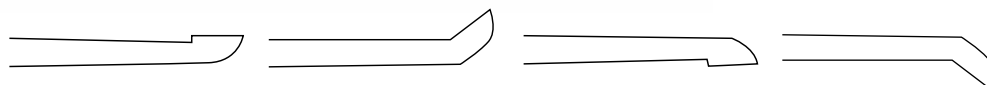

Shape	FS	FA	BS	BA
Cup 0	192-620-10	192-621-10	192-622-10	192-623-10
Cup 00	192-620-20	192-621-20	192-622-20	192-623-20
Cup 000	192-620-30	192-621-30	192-622-30	192-623-30
Cup 0000	192-620-40	192-621-40	192-622-40	192-623-40

	Large Cervical Bayonet Bone Cutter	24,0cm; 9 1/2"
--	------------------------------------	----------------

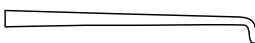
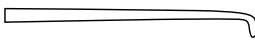

Shape	FS	FA	BS	BA
Cup 00	192-620-92	192-621-92	192-622-92	192-623-92

192-624-01	Large Cervical Bayonet Nerve Hook		24,0cm; 9 1/2"
192-624-02	Large Cervical Bayonet Ultra Nerve Hook		24,0cm; 9 1/2"
192-624-03	Large Cervical Bayonet Bone Waxer		24,0cm; 9 1/2"

Art.Nr.	Beschreibung Description	Size	Spez.
	Lumbar Bayonet Curettes	24,0cm; 9 1/2"	

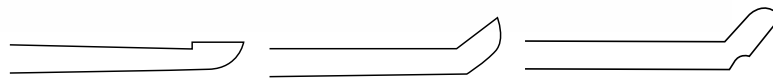

Shape	FS	FA	FD
Cup 0	192-600-00	192-601-00	192-602-00
Cup 1	192-600-01	192-601-01	192-602-01
Cup 2	192-600-02	192-601-02	192-602-02



Shape	BS	BA	BD
Cup 0	192-603-00	192-604-00	192-605-00
Cup 1	192-603-01	192-604-01	192-605-01
Cup 2	192-603-02	192-604-02	192-605-02

192-606-01	Lumbar Bayonet Penfield Dissector; #1		24,0cm; 9 1/2"
192-606-02	Lumbar Bayonet Penfield Dissector; #2		24,0cm; 9 1/2"
192-607-01	Lumbar Bayonet Nerve Hook		24,0cm; 9 1/2"
192-606-03	Lumbar Bayonet Penfield Dissector; #4		24,0cm; 9 1/2"
192-607-02	Lumbar Bayonet Cone Waxer		24,0cm; 9 1/2"
192-607-03	Lumbar Bayonet Spine Probe		24,0cm; 9 1/2"

Weitere Artikel
further items
más artículos

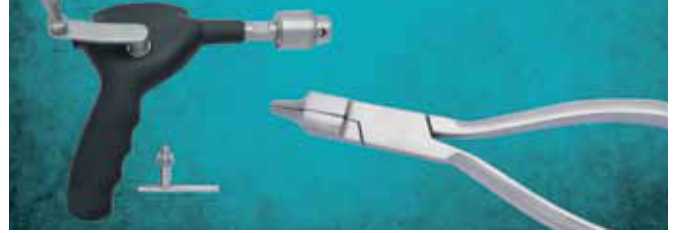

Art.Nr.	Beschreibung Description	Size	Spez.
Other items available but not illustrated			
	MARTINI bone curette		
192-408-00	fig. 00/0	14,0cm; 5,6"	
192-408-01	fig. 0/1	14,0cm; 5,6"	
192-408-12	fig. 1/2	14,0cm; 5,6"	
	WILLIGER bone curette	17,0cm; 6,8"	
192-430-00	fig. 00; oval; hollow handle		
192-430-01	fig. 0; oval; hollow handle		
192-430-11	fig. 01; oval; hollow handle		
192-430-12	fig. 02; oval; hollow handle		
192-432-00	fig. 00; rund; hollow handle		
192-432-01	fig. 0; rund; hollow handle		
192-432-11	fig. 1; rund; hollow handle		
192-432-12	fig. 2; rund; hollow handle		
192-444-00	SIMON bone curette; fig. 0	24,0cm; 9,6"	
192-448-05	LEMPERT bone curette; fig. 1; oval; Ø 3,3mm	21,5cm; 8,6"	
	SPRATT bone curette		
192-475-05	fig. 00000	17,0cm; 6,8"	
192-475-16	fig. 6	17,0cm; 6,8"	
192-476-01	fig. 0; straight	20,0cm; 8,0"	
192-476-02	fig. 00; straight	20,0cm; 8,0"	
192-476-03	fig. 000; straight	20,0cm; 8,0"	
	BRUNS bone curette	20,0cm; 8"	
192-477-01	fig. 0; angled		
192-477-02	fig. 00; angled		
192-477-03	fig. 000; angled		
192-477-04	fig. 0000; angled		
192-477-05	fig. 00000; angled		
192-477-11	fig. 1; angled		
192-477-12	fig. 2; angled		
192-477-13	fig. 3; angled		
192-477-14	fig. 4; angled		
192-477-15	fig. 5; angled		
192-477-16	fig. 6; angled		
192-478-04	fig. 0000; straight	23,0cm; 9,2"	
192-478-05	fig. 00000; straight	23,0cm; 9,2"	
192-479-04	fig. 0000; angled	22,5cm; 9,0"	
192-479-05	fig. 00000; angled	22,5cm; 9,0"	
	HATFIELD bone curette	23,0cm; 9,2"	
192-488-00	3,0 X 5,0mm		
192-488-01	3,5 X 5,5mm		
192-488-02	4,5 X 6,4mm		
192-488-03	5,0 X 8,0mm		

Weitere Artikel
 further items
 más artículos

Art.Nr.	Beschreibung Description	Size	Spez.
Other items available but not illustrated			
	HATFIELD bone curette	23,0cm; 9,2"	
192-488-04	6,0 X9,0mm		
192-488-05	7,0 X11,0mm		
192-488-06	8,5 X12,5mm		
192-488-07	9,5 X14,5mm		
192-488-08	10,5 X16,8mm		
	HATFIELD bone curette	28,0cm; 11,2"	
192-490-00	3,0 X5,0mm		
192-490-01	3,5 X5,5mm		
192-490-02	4,5 X6,4mm		
192-490-03	5,0 X8,04mm		
192-490-04	6,0 X9,0mm		
192-490-05	7,0 X11mm		
192-490-06	8,5 X12,5mm		
192-490-07	9,5 X14,5mm		
192-490-08	10,5 X16,8mm		
	COBB bone curette	28,0cm; 11,2"	
192-494-00	4,06 X5,08mm		
192-494-01	5,08 X 6,35mm		
192-494-02	6,1 X 7,62mm		
192-494-03	7,11 X 8,89mm		
192-494-04	8,13 X 10,16mm		
192-494-05	9,14 X 11,43mm		
192-494-06	10,16 X 12,7mm		
192-494-07	11,18 X 13,97mm		
192-494-08	12,19 X15,24mm		



hand drills



wire cutting pliers

193

Raspatorien
 Periosteal Elevators
 Periostótomos



Art.Nr. Beschreibung | Description Size Spez.

KEY



193-370-06

18,0cm; 7 1/8"
 6,5 mm



193-370-19

20,0cm; 8"
 19,5 mm



193-370-12

19,0cm; 7 4/8"
 12,5 mm

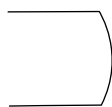

193-370-24

21,0cm; 8 1/4"
 24,5 mm



LANGENBECK

19,0cm; 7 4/8"



193-383-19

16,0 mm

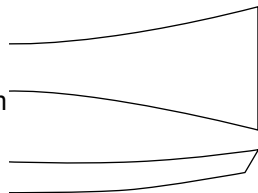

193-387-19

12,0 mm

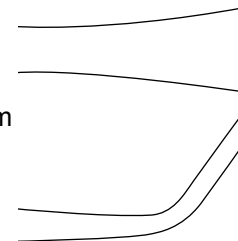

193-385-19

16,0 mm

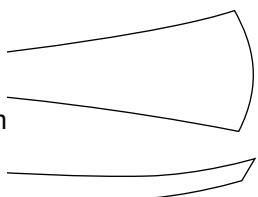

193-389-18

12,0 mm

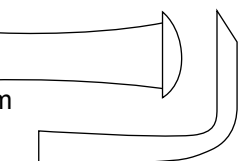

193

Raspatorien
 Periosteal Elevators
 Periostótomos

Art.Nr.	Beschreibung Description	Size	Spez.
---------	----------------------------	------	-------



17,0cm; 6 6/8"

193-399-06 6,0 mm

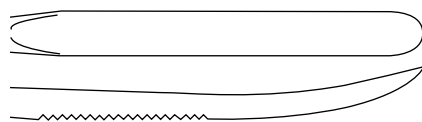

193-399-08 8,0 mm

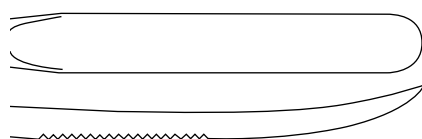





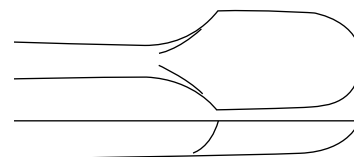

193-404-20

20,0cm; 7 7/8" FERROZELL
 14,0 mm

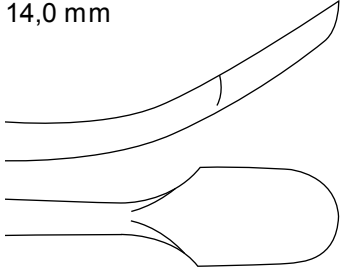

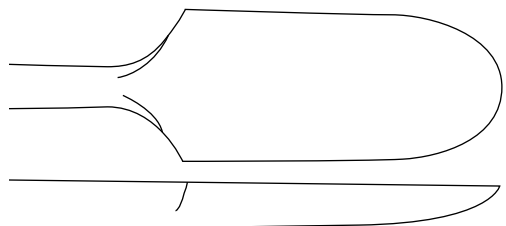

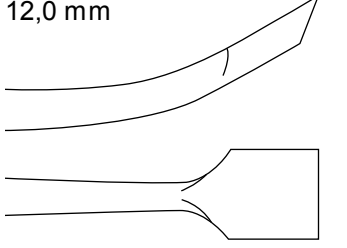

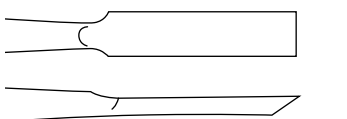

Raspatorien
 Periosteal Elevators
 Periostótomos

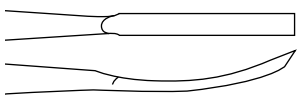

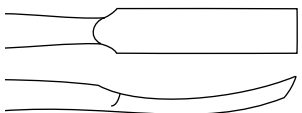
Art.Nr.	Beschreibung Description	Size	Spez.
193-405-20		19,0cm; 7 4/8" FERROZELL 14,0 mm	
193-408-20		20,5cm; 7 1/8" FERROZELL 20,0 mm	
193-411-19		19,0cm; 7 4/8" FERROZELL 12,0 mm	
193-414-18		18,0cm; 7 4/8" FERROZELL 6,0 mm	

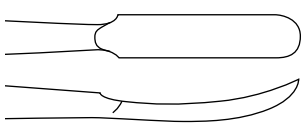
Raspatorien
 Periosteal Elevators
 Periostótomos

Art.Nr.	Beschreibung Description	Size	Spez.
193-415-18		18,0cm; 7 1/8" FERROZELL 3,0 mm	
193-417-18		18,0cm; 7 1/8" FERROZELL 6,0 mm	
193-419-18		18,0cm; 7 1/8" FERROZELL 6,0 mm	
193-437-21	<p data-bbox="263 1500 438 1556">ALDERDYCE</p>  	21,0cm; 8 2/8"	

Raspatorien; Elevatorien
 Periosteal Elevators
 Periostótomos; Elevadores



Art.Nr.	Beschreibung Description	Size	Spez.
193-440-19	MCDONALD	18,5cm; 7 2/8"	

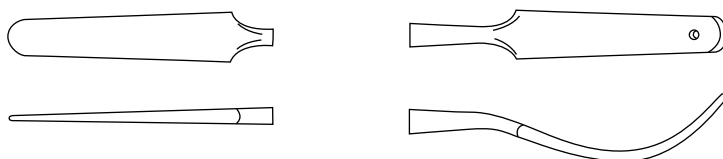

HOEN



193-463-07	16,0cm; 6 2/8" 7,0 mm	
------------	--------------------------	--

193-463-15	19,0cm; 7 4/8" 15,0 mm	
------------	---------------------------	--

193-463-20	19,0cm; 7 4/8" 20,0 mm	
------------	---------------------------	--

193

Raspatorien
 Periosteal Elevators
 Periostótomos

Art.Nr. Beschreibung | Description Size Spez.

CUSHING



193-464-04 4,0 mm 17,5cm; 7"

193-464-05 5,0 mm 17,5cm; 7"

193-464-06 6,0 mm 19,5cm; 7 6/8"

193-464-07 7,0 mm 19,5cm; 7 6/8"

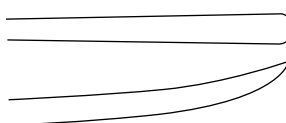

ADSON

17,0cm; 6 6/8"



193-465-01 8,0 mm

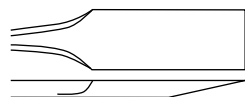

193-465-02 7,0 mm



193-465-03 7,0 mm



193-465-04 7,0 mm

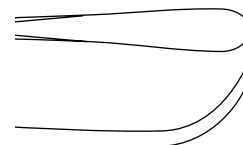

193-466-08 CUSHING

17,0cm; 6 6/8"
8,0 mm





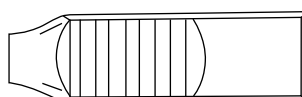
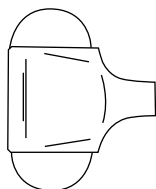

193-469-21 ALEXANDER

21,0cm; 8 2/8"

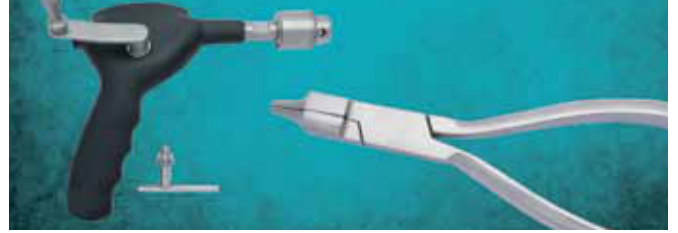

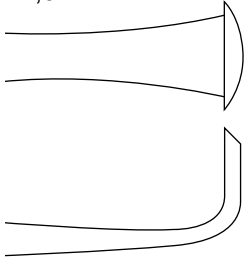
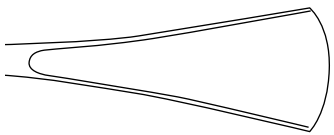

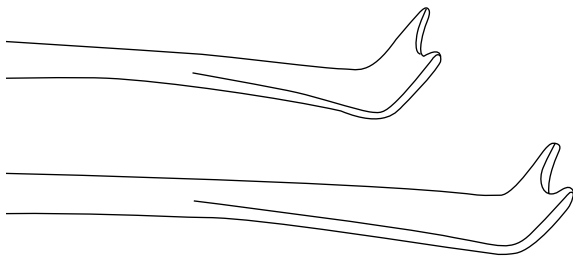
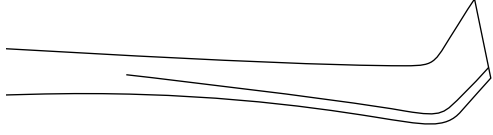
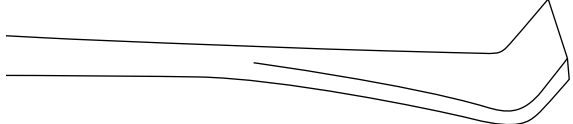





Raspatorien
 Periosteal Elevators
 Periostótomos

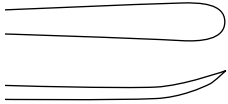

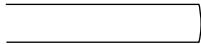
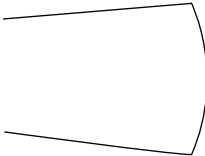
Art.Nr.	Beschreibung Description	Size	Spez.
193-471-18	LANGENBECK	18,0cm; 7 1/8" 14,0 mm	
193-472-19	LANGENBECK	19,0cm; 7 4/8" 16,0 mm	
	SEMB		
193-473-01	Fig. 1 12,0 mm		19,0cm; 7 4/8"
193-473-02	Fig. 2 12,0 mm		22,0cm; 8 5/8"
193-473-03	Fig. 3 14,0 mm		19,0cm; 7 4/8"
193-473-04	Fig. 4 14,0 mm		22,0cm; 8 5/8"
193-473-05	Fig. 5 16,0 mm		23,0cm; 9"

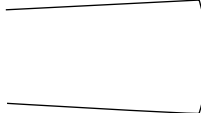
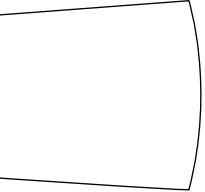

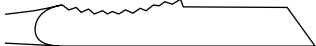

193

Raspatorien
 Periosteal Elevators
 Periostótomos

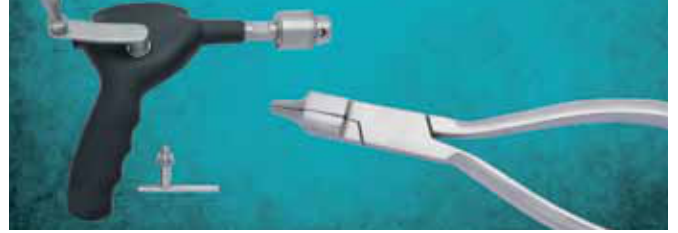
Art.Nr.	Beschreibung Description	Size	Spez.
193-476-15	KÖNIG 	15,5cm; 6 1/8" 5,0 mm 	
	LAMBOTTE 	21,5cm; 8 4/8" 	
193-477-05	5,0 mm 	193-477-20 20,0 mm	
193-477-10	10,0 mm 		
193-477-15	15,0 mm 	193-477-25 25,0 mm	
193-478-15	FARABEUF 	15,5cm; 6 1/8" 12,5 mm 	
193-479-15	FARABEUF 	15,5cm; 6 1/8" 12,5 mm 	

Raspatorien
 Periosteal Elevators
 Periostótomos

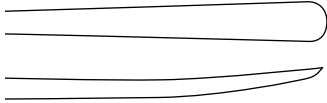

Art.Nr.	Beschreibung Description	Size	Spez.
	WILLIGER	16,0cm; 6 4/8"	
			
193-480-04	4,0 mm		
193-480-06	6,0 mm 		
193-480-08	8,0 mm		
193-480-14	WILLIGER	13,0cm; 5 1/8" 6,0 mm	
			
193-488-21	SEDILLOT	22,0cm; 8 5/8" 15,0 mm	
			

Raspatorien
 Periosteal Elevators
 Periostótomos

Art.Nr. Beschreibung | Description Size Spez.

DOYEN für Erwachsene
 for adults
 para adultos 17,5cm; 7"



193-481-17

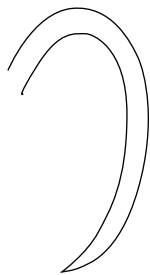

rechts gebogen
 curved right
 curva a la derecha

193-483-17



links gebogen
 curved left
 curva a la izquierda

DOYEN für Kinder
 for children
 para niños 17,5cm; 7"



193-485-17

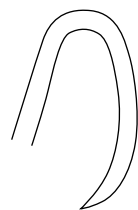

rechts gebogen
 curved right
 curva a la derecha

193-487-17



links gebogen
 curved left
 curva a la izquierda

Raspatorien
 Periosteal Elevators
 Periostótomos

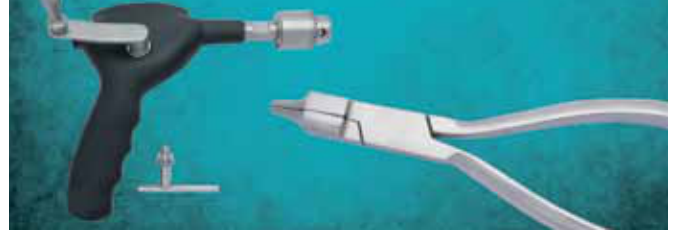

Art.Nr.	Beschreibung Description	Size	Spez.
	COBB	28,0cm; 11"	



193-493-10

10,0 mm

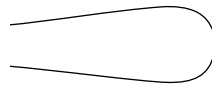

193-493-19

19,0 mm

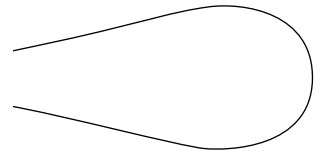

193-493-13

13,0 mm

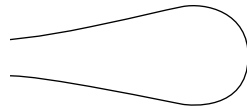

193-493-25

25,0 mm

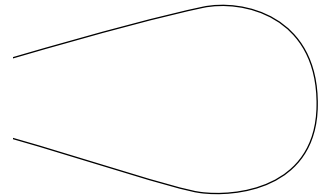

COBB

25,0cm; 9 7/8" FERROZELL



193-495-10

10,0 mm

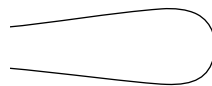

193-495-19

19,0 mm

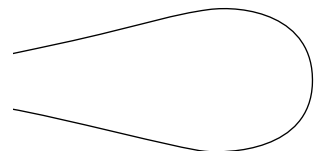

193-495-13

13,0 mm

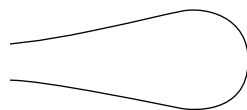

193-495-25

25,0 mm

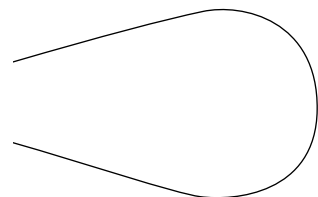

193

Raspatorien
 Periosteal Elevators
 Periostótomos

Art.Nr.	Beschreibung Description	Size	Spez.
	WAGNER	33,0cm; 13"	FERROZELL



193-497-08 8,0 mm



193-497-17 17,0 mm

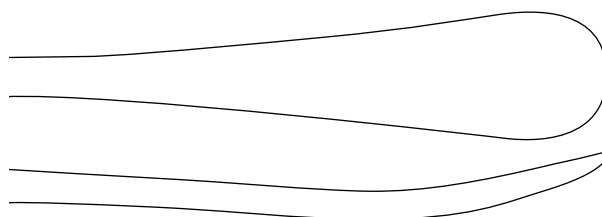

193-499-27

27,5cm; 10 7/8" FERROZELL
 20,0 mm

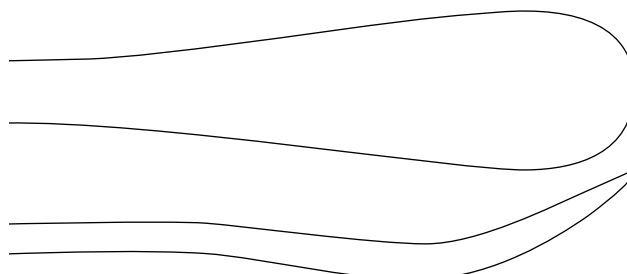

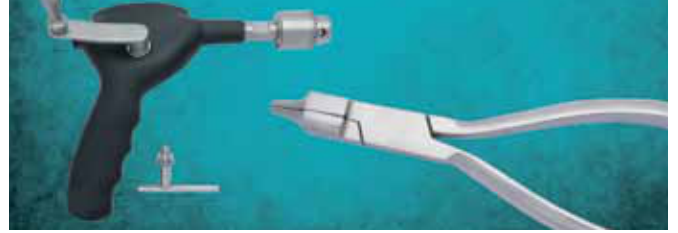

Art.Nr.	Beschreibung Description	Size	Spez.
---------	----------------------------	------	-------

WILLIGER



193-512-16

16,0cm; 6 2/8"
4,0 mm

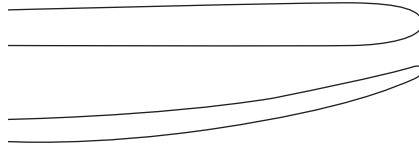

193-512-17

17,0cm; 6 6/8"
7,0 mm

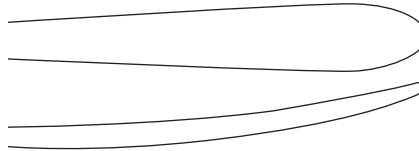

LANGENBECK

19,5cm; 7 5/8"



193-520-08

8,0 mm



193-520-10

10,0 mm

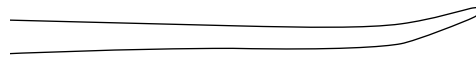



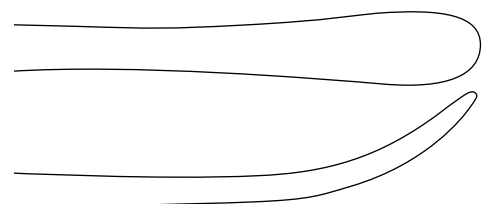

193-521-23

LANGENBECK

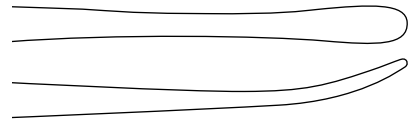
23,0cm; 9"
11,0 mm

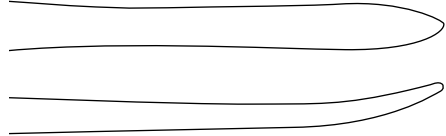

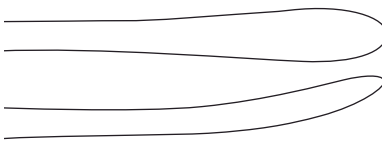
Art.Nr.	Beschreibung Description	Size	Spez.
193-523-17	SEBILEAU	17,0cm; 6 6/8" 5,0 mm	
			
193-525-19	QUERVAIN	20,0cm; 8" 6,0 mm	
			
	LANGENBECK		
			
193-526-05	5,0 mm	17,0cm; 6 6/8"	
193-526-07	7,0 mm	17,0cm; 6 6/8"	
193-526-08	8,0 mm	19,5cm; 7 5/8"	
193-526-10	10,0 mm	19,5cm; 7 5/8"	

Knochenfeilen
 Bone Files
 Limas para huesos

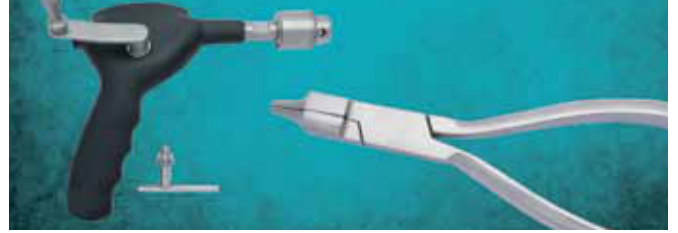

Art.Nr.	Beschreibung Description	Size	Spez.
193-610-22		22,0cm; 8 5/8"	

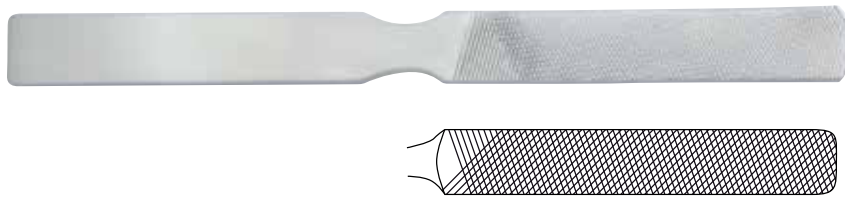

193-611-24		25,0cm; 9 7/8"	
------------	--	----------------	--

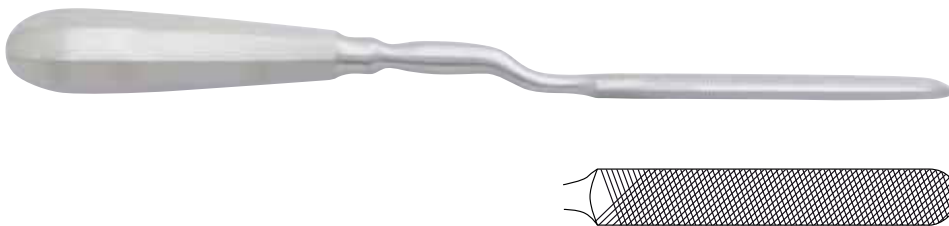

193-612-28		28,0cm; 11"	
------------	--	-------------	--

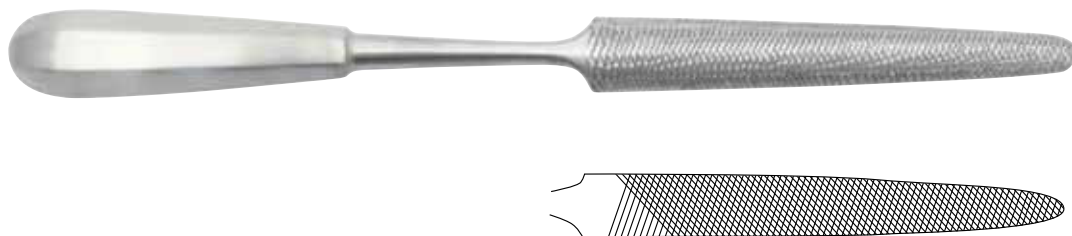

Knochenfeilen
 Bone Files
 Limas para huesos

Art.Nr.	Beschreibung Description	Size	Spez.
	MILLER-COLBURN auf zug schneidend downwards cutting corte abajo	18,0cm; 7 1/8"	

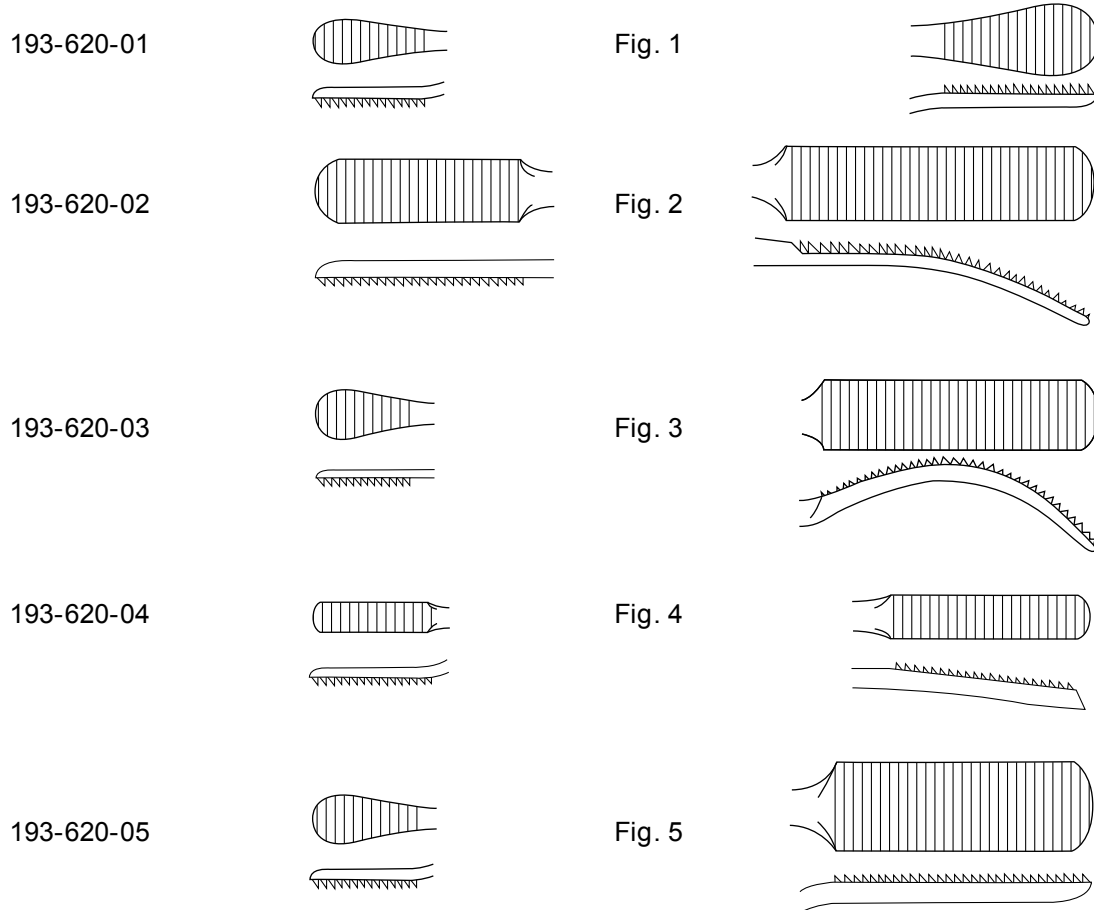

Knochenfeilen
 Bone Files
 Limas para huesos

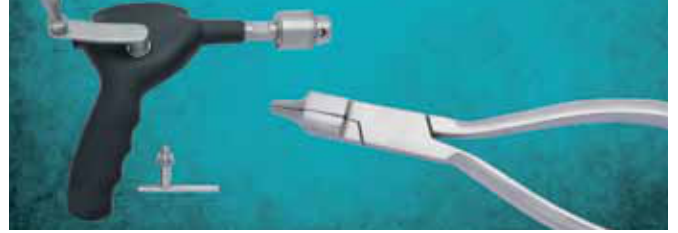

Art.Nr.	Beschreibung Description	Size	Spez.
	MILLER-COLBURN kreuzhieb cross cut picado en cruz	18,0cm; 7 1/8"	



193-621-01

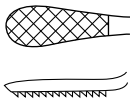
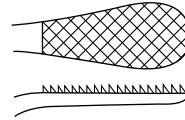

Fig. 1



193-621-02

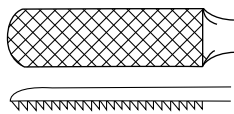
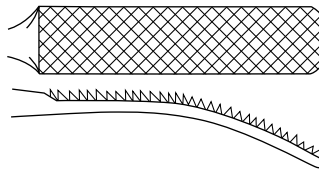

Fig. 2



193-621-03

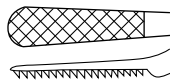
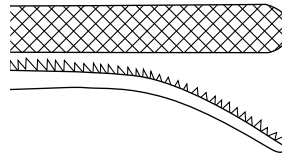

Fig. 3



193-621-04

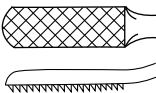
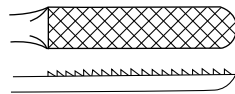

Fig. 4



193

Stößel
Tampers
Punzones metálicos

Art.Nr.	Beschreibung Description	Size	Spez.
		15,5cm; 6 1/8"	



193-640-02	Ø 2,0 mm	
193-640-03	Ø 3,0 mm	
193-640-04	Ø 4,0 mm	
193-640-05	Ø 5,0 mm	
193-640-06	Ø 6,0 mm	
193-640-08	Ø 8,0 mm	
193-640-10	Ø 10,0 mm	

Weitere Artikel
further items
más artículos

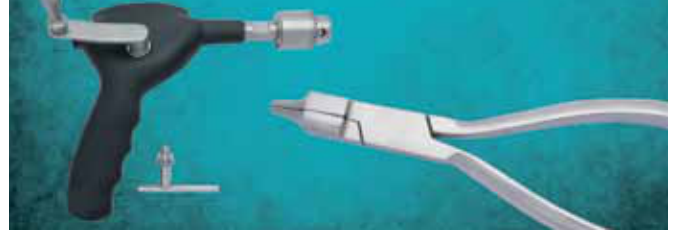

Art.Nr.	Beschreibung Description	Size	Spez.
Other items available but not illustrated			
193-370-03	KEY periosteal elevator 3,0mm; slightly curved	17,5cm; 7"	
193-370-16	16,0mm; slightly curved	20,0cm; 8,0"	
193-377-17	SCHNEIDER raspatory 13,0mm; angled	17,5cm; 7"	
193-379-19	13,0mm; angled	19,0cm; 7,6"	
193-391-01	MÜHLING raspatory fig. 1; 4,0mm; hook curved	17,0cm; 6,8"	
193-391-02	fig. 2; 4,0mm; long curved		
193-391-03	fig. 3; 4,0mm; short curved		
193-391-04	fig. 4; 4,0mm; spoon shaped		
193-393-16	JANSEN raspatory; 12,0mm; light curved	16,5cm; 6,6"	
193-395-15	FARABEU-FOLLIN periosteal raspatory 11,0mm; straight	15,5cm; 6,2"	
193-397-15	11,0mm; curved		
193-431-17	elevator; extremely light weight	17,5cm; 7"	
193-433-16	micro-elevator	16,0cm; 6,4"	
193-451-19	FREER septum elevator sharp	19,0cm; 7,6"	
193-453-19	blunt	19,0cm; 7,6"	
193-455-19	sharp/blunt	18,0cm; 7,2"	
193-457-19	6,5mm; sharp/blunt; double ended	18,0cm; 7,2"	
193-461-05	raspatory 5,0mm	16,0cm; 6,4"	
193-461-06	6,0mm		
193-461-07	7,0mm		
193-467-22	MATSON raspatory	22,0cm; 8,8"	
193-469-15	ALEXANDER periosteal elevator; 10/14mm; double ended	15,0cm; 6"	
193-475-01	SEMB costal periosteotome fig. 1	17,5cm; 7"	
193-475-02	fig. 2	21,0cm; 8,4"	
193-475-03	fig. 3	17,5cm; 7"	
193-475-04	fig. 4	21,0cm; 8,4"	
193-475-05	fig. 5		
193-480-13	WILLIGER periosteal elevator	13,0cm; 5,2"	

Weitere Artikel
 further items
 más artículos

Art.Nr.	Beschreibung Description	Size	Spez.
Other items available but not illustrated			
193-485-15 193-487-15	DOYEN-BABY periosteal elevator left hand; straight shaft right hand; straight shaft	15,0cm; 6"	
193-489-19	SEDILLOT periosteal elevator; 18,0mm; solid handle	19,0cm; 7,6"	
193-501-17	WATSON-CHEYNE periosteal elevator	17,0cm; 6,8"	
193-621-05	MILLER-COLBURN bone file; fig. 5; cross-serrated; double ended	19,0cm; 7,6"	
193-624-01	TC MILLER-COLBURN bone file; fig. 1; 8,0mm/ 5,0mm	19,0cm; 7,6"	
193-625-27 193-625-30	PUTTI raspatorium	27,0cm; 10,8" 30,0cm; 12"	
193-642-03 193-642-05 193-642-08 193-642-12 193-642-14 193-642-16	tamper Ø 3,0mm; with wooden handle Ø 5,0mm; with wooden handle Ø 8,0mm; with wooden handle Ø 12,0mm; with wooden handle Ø 14,0mm; with wooden handle Ø 16,0mm; with wooden handle	20,0cm; 8"	



hand drills

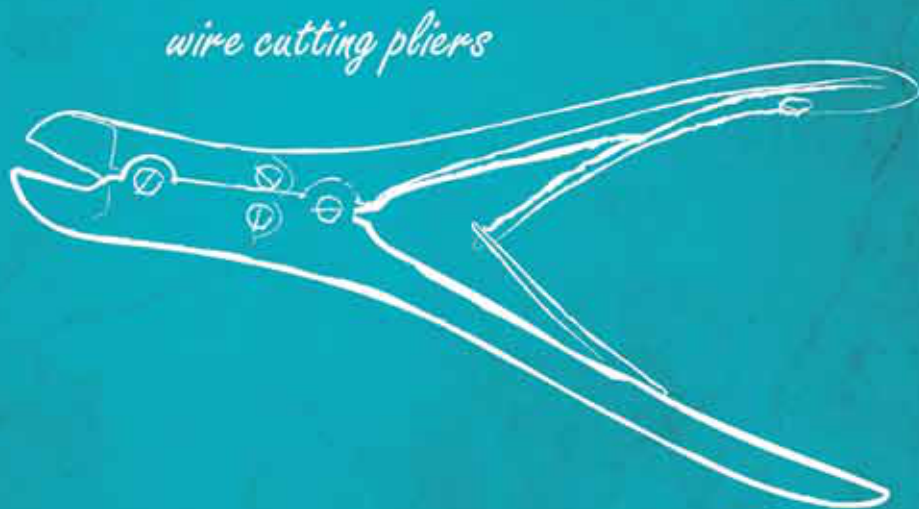

wire cutting pliers

Osteotome
Osteotomes

194



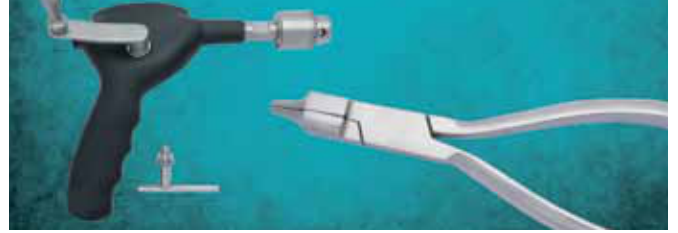









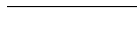
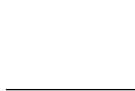







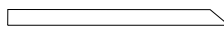
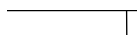

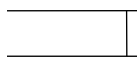

Schädelspalter
Skull Breaker
Cinzel rompe-cráneo



Art.Nr.	Beschreibung Description	Size	Spez.
194-280-12	VIRCHOW	7,5cm; 3"	

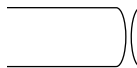

Osteotome; Flachmeißel; Hohlmeißel
 Osteotomes; Chisels; Gouges
 Osteótomos; Cinceles; Gubias

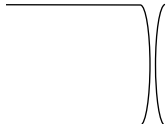
Art.Nr.	Beschreibung Description	Size	Spez.
 		13,5cm; 5 3/8"	
194-300-04	4,0 mm 	194-300-12	12,0 mm 
194-300-06	6,0 mm 	194-300-14	14,0 mm 
194-300-08	8,0 mm 		
194-300-10	10,0 mm 	194-300-16	16,0 mm 
 		13,5cm; 5 3/8"	
194-301-04	4,0 mm 	194-301-12	12,0 mm 
194-301-06	6,0 mm 		
194-301-08	8,0 mm 	194-301-14	14,0 mm 
194-301-10	10,0 mm 	194-301-16	16,0 mm 
		13,5cm; 5 3/8"	
194-302-04	4,0 mm 	194-302-12	12,0 mm 
194-302-06	6,0 mm 	194-302-14	14,0 mm 
194-302-08	8,0 mm 		
194-302-10	10,0 mm 	194-302-16	16,0 mm 

Osteotome; Flachmeißel; Hohlmeißel
 Osteotomes; Chisels; Gouges
 Osteótomos; Cinceles; Gubias

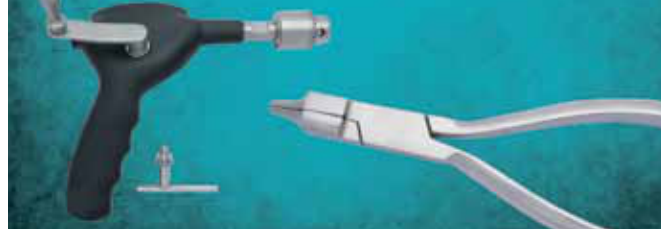

Art.Nr. Beschreibung | Description Size Spez.

HOKE

14,0cm; 5 4/8"



194-306-02	2,0 mm	<input type="checkbox"/>	194-306-06	6,0 mm	<input type="checkbox"/>
194-306-03	3,0 mm	<input type="checkbox"/>	194-306-07	7,0 mm	<input type="checkbox"/>
194-306-04	4,0 mm	<input type="checkbox"/>	194-306-08	8,0 mm	<input type="checkbox"/>
194-306-05	5,0 mm	<input type="checkbox"/>	194-306-09	9,0 mm	<input type="checkbox"/>

HOKE

14,0cm; 5 4/8"



194-307-02	2,0 mm	<input type="checkbox"/>	194-307-06	6,0 mm	<input type="checkbox"/>
194-307-03	3,0 mm	<input type="checkbox"/>	194-307-07	7,0 mm	<input type="checkbox"/>
194-307-04	4,0 mm	<input type="checkbox"/>	194-307-08	8,0 mm	<input type="checkbox"/>
194-307-05	5,0 mm	<input type="checkbox"/>			

194

Osteotome; Flachmeißel; Hohlmeißel
 Osteotomes; Chisels; Gouges
 Osteótomos; Cinceles; Gubias

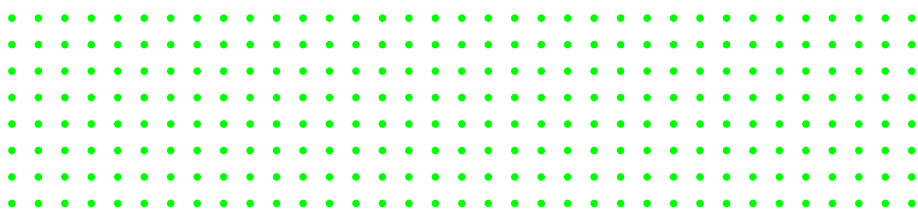

Art.Nr.	Beschreibung Description	Size	Spez.
ALEXANDER		17,5cm; 6 7/8"	



194-316-04	4,0 mm		194-316-10	10,0 mm	
194-316-06	6,0 mm		194-316-12	12,0 mm	
194-316-08	8,0 mm		194-316-14	14,0 mm	

ALEXANDER		17,5cm; 6 7/8"
-----------	--	----------------



194-318-04	4,0 mm		194-318-10	10,0 mm	
194-318-06	6,0 mm		194-318-12	12,0 mm	
194-318-08	8,0 mm		194-318-14	14,0 mm	

ALEXANDER		17,5cm; 6 7/8"
-----------	--	----------------



194-319-04	4,0 mm		194-319-10	10,0 mm	
194-319-06	6,0 mm		194-319-12	12,0 mm	
194-319-08	8,0 mm		194-319-14	14,0 mm	

Osteotome; Flachmeißel; Hohlmeißel
 Osteotomes; Chisels; Gouges
 Osteótomos; Cinceles; Gubias

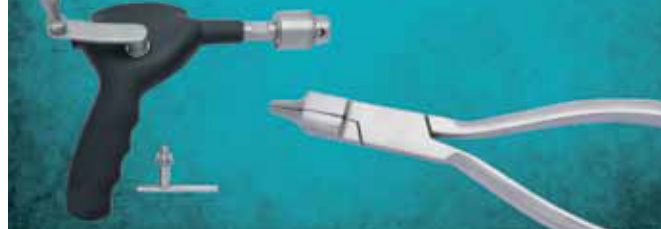

Art.Nr. Beschreibung | Description Size Spez.

PARTSCH

13,5cm; 5 3/8"



194-334-02	2,0 mm		194-334-05	5,0 mm	
194-334-03	3,0 mm		194-334-06	6,0 mm	
194-334-04	4,0 mm				

PARTSCH

13,5cm; 5 3/8"



194-336-02	2,0 mm		194-336-05	5,0 mm	
194-336-03	3,0 mm		194-336-06	6,0 mm	
194-336-04	4,0 mm				

PARTSCH

17,0cm; 6 6/8"



194-338-02	2,0 mm		194-338-05	5,0 mm	
194-338-03	3,0 mm		194-338-06	6,0 mm	
194-338-04	4,0 mm				

194

Osteotome; Flachmeißel; Hohlmeißel
 Osteotomes; Chisels; Gouges
 Osteótomos; Cinceles; Gubias

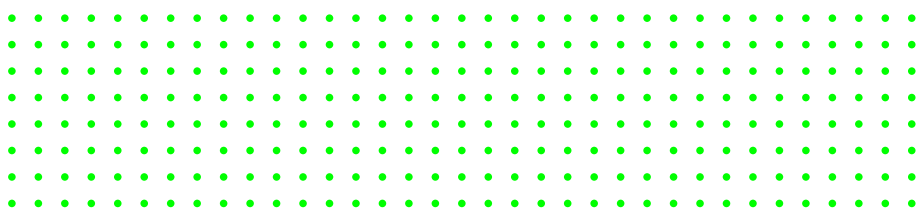

Art.Nr.	Beschreibung Description	Size	Spez.
---------	----------------------------	------	-------

PARTSCH

17,0cm; 6 6/8"



194-340-02	2,0 mm		194-340-05	5,0 mm	
194-340-03	3,0 mm		194-340-06	6,0 mm	
194-340-04	4,0 mm				

HIBBS

24,5cm; 9 5/8"



194-342-06	6,0 mm		194-342-22	22,0 mm	
194-342-09	9,0 mm				
194-342-13	13,0 mm		194-342-25	25,0 mm	
194-342-16	16,0 mm				
194-342-19	19,0 mm		194-342-32	32,0 mm	

Osteotome; Flachmeißel; Hohlmeißel
 Osteotomes; Chisels; Gouges
 Osteótomos; Cinceles; Gubias



Art.Nr.	Beschreibung Description	Size	Spez.
---------	----------------------------	------	-------

HIBBS

24,5cm; 9 5/8"

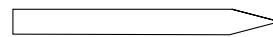

194-344-06

6,0 mm



194-344-25

25,0 mm

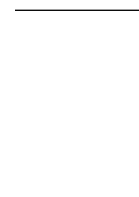

194-344-09

9,0 mm



194-344-13

13,0 mm



194-344-28

28,0 mm



194-344-16

16,0 mm



194-344-19

19,0 mm

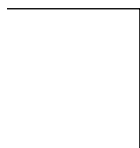

194-344-32

32,0 mm



194-344-22

22,0 mm



194

Osteotome; Flachmeißel; Hohlmeißel
 Osteotomes; Chisels; Gouges
 Osteótomos; Cinceles; Gubias

Art.Nr.	Beschreibung Description	Size	Spez.
---------	----------------------------	------	-------

HIBBS

24,5cm; 9 5/8"



194-345-06

6,0 mm

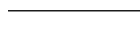

194-345-25

25,0 mm



194-345-09

9,0 mm



194-345-13

13,0 mm



194-345-28

28,0 mm



194-345-16

16,0 mm



194-345-19

19,0 mm



194-345-32

32,0 mm



194-345-22

22,0 mm



Osteotome; Flachmeißel; Hohlmeißel
 Osteotomes; Chisels; Gouges
 Osteótomos; Cinceles; Gubias



Art.Nr.	Beschreibung Description	Size	Spez.
---------	----------------------------	------	-------

HIBBS

24,5cm; 9 5/8"



194-346-06

6,0 mm



194-346-25

25,0 mm

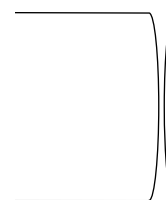

194-346-09

9,0 mm



194-346-13

13,0 mm



194-346-28

28,0 mm

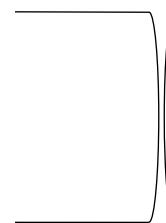

194-346-16

16,0 mm

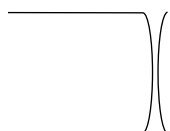

194-346-19

19,0 mm

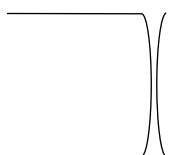

194-346-32

32,0 mm

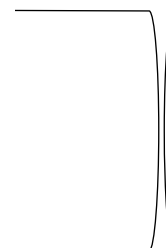

194-346-22

22,0 mm

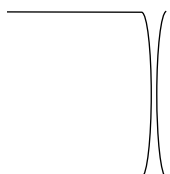

194

Osteotome; Flachmeißel; Hohlmeißel
 Osteotomes; Chisels; Gouges
 Osteótomos; Cinceles; Gubias

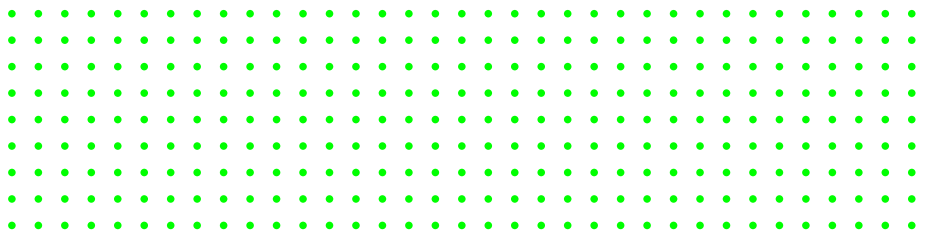

Art.Nr.	Beschreibung Description	Size	Spez.
---------	----------------------------	------	-------

HIBBS

24,5cm; 9 5/8"



194-347-06

6,0 mm

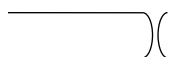

194-347-25

25,0 mm

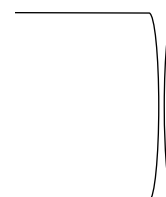

194-347-09

9,0 mm

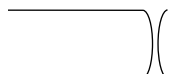

194-347-13

13,0 mm



194-347-28

28,0 mm

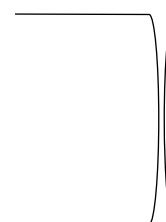

194-347-16

16,0 mm

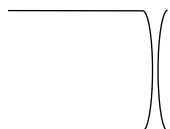

194-347-19

19,0 mm

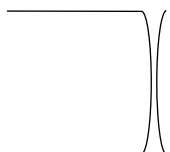

194-347-32

32,0 mm



194-347-22

22,0 mm

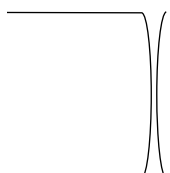

Osteotome; Flachmeißel; Hohlmeißel
 Osteotomes; Chisels; Gouges
 Osteótomos; Cinceles; Gubias

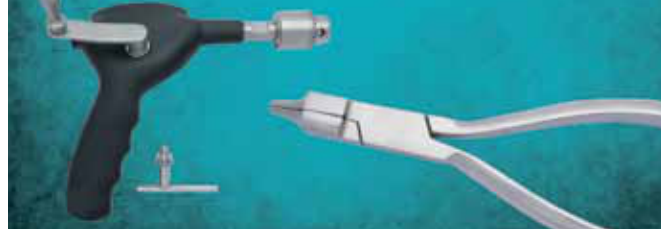

Art.Nr.	Beschreibung Description	Size	Spez.
---------	----------------------------	------	-------

SMITH-PETERSEN

20,5cm; 8 1/8"



194-350-06

6,0 mm

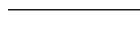

194-350-25

25,0 mm



194-350-09

9,0 mm



194-350-13

13,0 mm

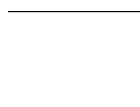

194-350-32

32,0 mm



194-350-16

16,0 mm



194-350-19

19,0 mm

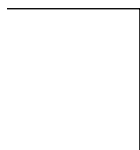

194

Osteotome; Flachmeißel; Hohlmeißel
 Osteotomes; Chisels; Gouges
 Osteótomos; Cinceles; Gubias

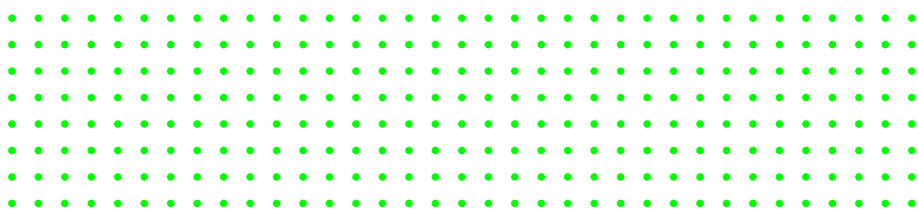

Art.Nr.	Beschreibung Description	Size	Spez.
	SMITH-PETERSEN	20,5cm; 8 1/8"	



194-351-06

6,0 mm



194-351-25

25,0 mm



194-351-09

9,0 mm

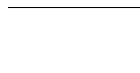

194-351-13

13,0 mm

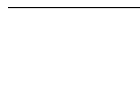

194-351-32

32,0 mm



194-351-16

16,0 mm



194-351-19

19,0 mm



Osteotome; Flachmeißel; Hohlmeißel
 Osteotomes; Chisels; Gouges
 Osteótomos; Cinceles; Gubias

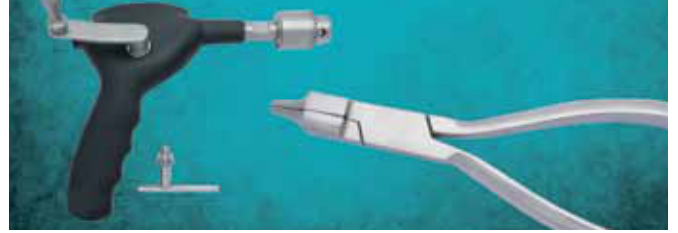

Art.Nr. Beschreibung | Description Size Spez.

SMITH-PETERSEN

20,5cm; 8 1/8"



194-352-09

9,0 mm

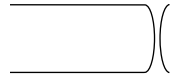

194-352-19

19,0 mm

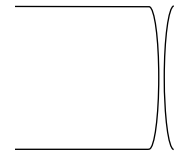

194-352-14

13,0 mm



194-352-16

16,0 mm

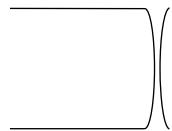

194-352-25

25,0 mm

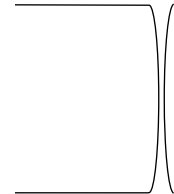

SMITH-PETERSEN

20,5cm; 8 1/8"



194-353-09

9,0 mm

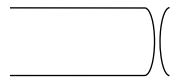

194-353-19

19,0 mm

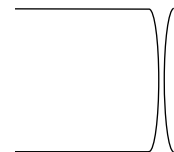

194-353-14

13,0 mm

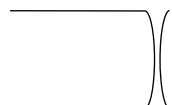

194-353-16

16,0 mm

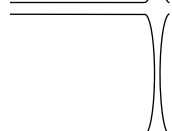

194-353-25

25,0 mm

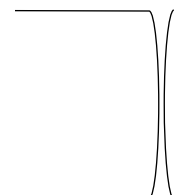

194

Osteotome; Flachmeißel; Hohlmeißel
 Osteotomes; Chisels; Gouges
 Osteótomos; Cinceles; Gubias

Art.Nr. Beschreibung | Description Size Spez.

STILLE

20,5cm; 8 1/8"



194-360-10

10,0 mm



194-360-20

20,0 mm

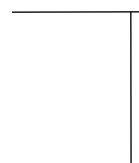

194-360-12

12,0 mm



194-360-15

15,0 mm

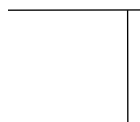

194-360-25

25,0 mm

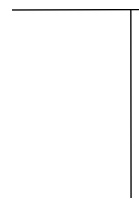

STILLE

20,5cm; 8 1/8"

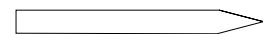

194-361-08

8,0 mm

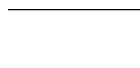

194-361-20

20,0 mm



194-361-10

10,0 mm

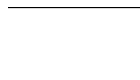

194-361-12

12,0 mm



194-361-25

25,0 mm



194-361-15

15,0 mm



194-361-30

30,0 mm



Osteotome; Flachmeißel; Hohlmeißel
 Osteotomes; Chisels; Gouges
 Osteótomos; Cinceles; Gubias



Art.Nr.	Beschreibung Description	Size	Spez.
---------	----------------------------	------	-------

STILLE

20,5cm; 8 1/8"



194-362-10

10,0 mm



194-362-20

20,0 mm

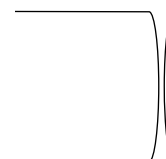

194-362-12

12,0 mm

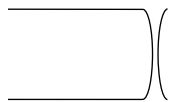

194-362-15

15,0 mm



194-362-25

25,0 mm

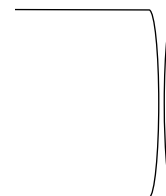

MINI-LEXER

18,0cm; 7 1/8" FERROZELL



194-370-04

4,0 mm

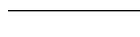

194-370-10

10,0 mm



194-370-06

6,0 mm

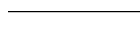

194-370-12

12,0 mm



194-370-08

8,0 mm



194

Osteotome; Flachmeißel; Hohlmeißel
 Osteotomes; Chisels; Gouges
 Osteótomos; Cinceles; Gubias

Art.Nr.	Beschreibung Description	Size	Spez.
	MINI-LEXER	18,0cm; 7 1/8"	FERROZELL



194-372-04	4,0 mm		194-372-10	10,0 mm	
194-372-06	6,0 mm		194-372-12	12,0 mm	
194-372-08	8,0 mm				

	LEXER	22,0cm; 8 5/8"	FERROZELL
--	-------	----------------	-----------



194-374-05	5,0 mm		194-374-20	20,0 mm	
194-374-07	7,0 mm				
194-374-10	10,0 mm		194-374-25	25,0 mm	
194-374-15	15,0 mm				
			194-374-30	30,0 mm	

Osteotome; Flachmeißel; Hohlmeißel
 Osteotomes; Chisels; Gouges
 Osteótomos; Cinceles; Gubias

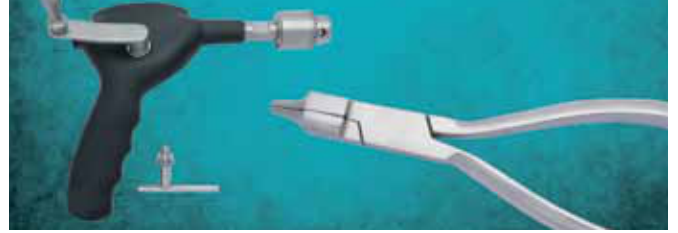

Art.Nr.	Beschreibung Description	Size	Spez.
	LEXER	22,0cm; 8 5/8"	FERROZELL



194-376-05	5,0 mm		194-376-20	20,0 mm	
194-376-07	7,0 mm				
194-376-10	10,0 mm		194-376-25	25,0 mm	
194-376-15	15,0 mm				
			194-376-30	30,0 mm	

	LEXER	27,5cm; 10 7/8"	FERROZELL
--	-------	-----------------	-----------



194-381-10	10,0 mm	
194-381-15	15,0 mm	

194

Osteotome; Flachmeißel; Hohlmeißel
 Osteotomes; Chisels; Gouges
 Osteótomos; Cinceles; Gubias

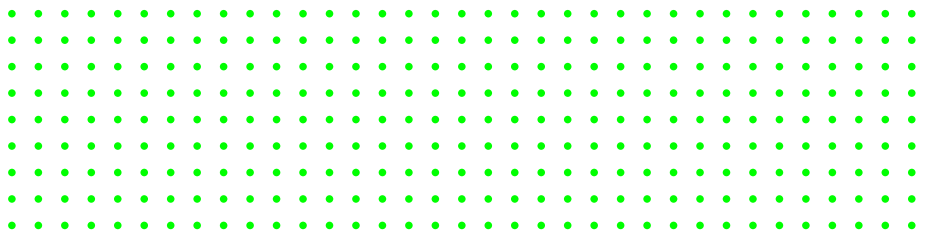

Art.Nr.	Beschreibung Description	Size	Spez.
	LEXER	27,5cm; 10 7/8"	FERROZELL



194-383-10	5,0 mm	
------------	--------	--

194-383-15	7,0 mm	
------------	--------	--

	LEXER	24,5cm; 9 5/8"	FERROZELL
--	-------	----------------	-----------



194-386-05	5,0 mm	
------------	--------	--

194-386-10	10,0 mm	
------------	---------	--

194-386-15	15,0 mm	
------------	---------	--

Osteotome; Flachmeißel; Hohlmeißel
 Osteotomes; Chisels; Gouges
 Osteótomos; Cinceles; Gubias

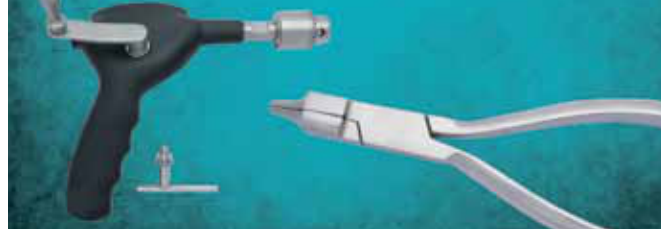

Art.Nr.	Beschreibung Description	Size	Spez.
	LEXER	24,5cm; 9 5/8"	FERROZELL



194-387-05 5,0 mm  (

194-387-10 10,0 mm  (

194-387-15 15,0 mm  (

	LEXER	28,5cm; 11 2/8"	FERROZELL
--	-------	-----------------	-----------

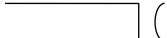

194-388-07 5,0 mm  (

194-388-10 10,0 mm  (

Osteotome; Flachmeißel; Hohlmeißel
 Osteotomes; Chisels; Gouges
 Osteótomos; Cinceles; Gubias

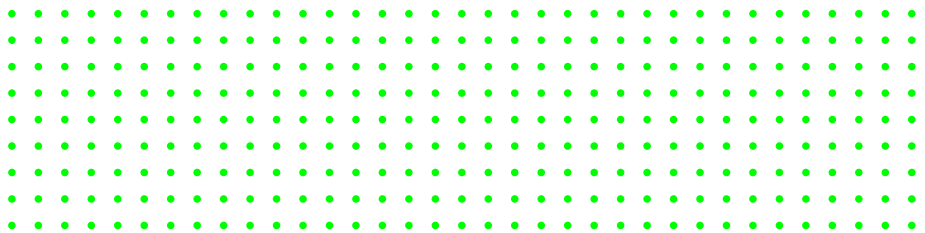

Art.Nr.	Beschreibung Description	Size	Spez.
194-390-28	COBB	27,5cm; 10 7/8" 8,0 mm	FERROZELL

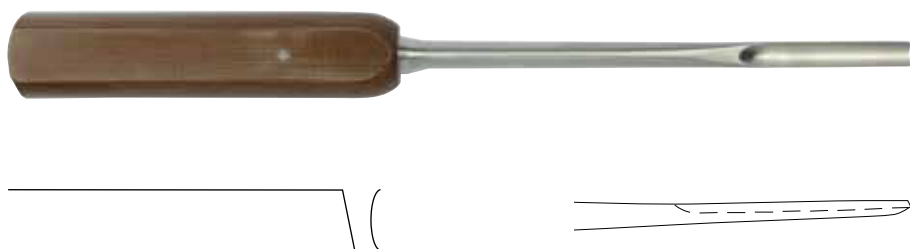

194-391-27	COBB	27,5cm; 10 7/8" 8,0 mm	FERROZELL
------------	------	---------------------------	-----------



194-393-27	COBB	27,5cm; 10 7/8" 8,0 mm	FERROZELL
------------	------	---------------------------	-----------

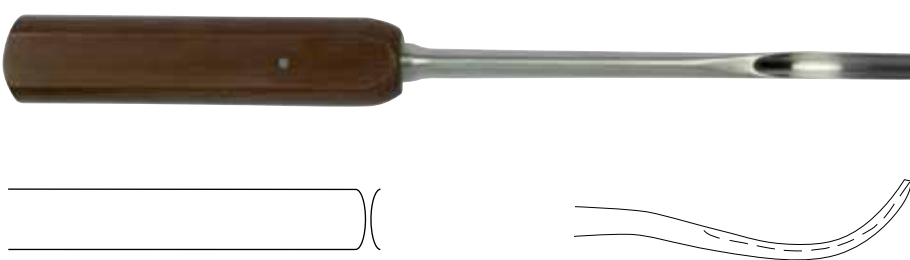

194-395-27	COBB	27,5cm; 10 7/8" 8,0 mm	FERROZELL
------------	------	---------------------------	-----------



Osteotome; Flachmeißel; Hohlmeißel
 Osteotomes; Chisels; Gouges
 Osteótomos; Cinceles; Gubias

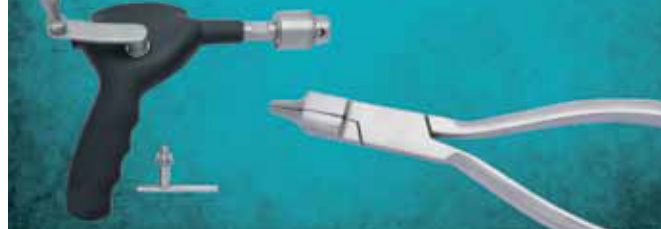

Art.Nr.	Beschreibung Description	Size	Spez.
	DAHMEN	30,0cm; 11 6/8"	FERROZELL



	Osteotom Osteotome Osteótomos	Hohlmeißel Gouge Gubias	Osteotom Osteotome Osteótomos	Hohlmeißel Gouge Gubias
4,0 mm	194-402-04	194-406-04	194-403-04	194-407-04
5,0 mm	194-402-05	194-406-05	194-403-05	194-407-05
6,0 mm	194-402-06	194-406-06	194-403-06	194-407-06
8,0 mm	194-402-08	194-406-08	194-403-08	194-407-08
10,0 mm	194-402-10	194-406-10	194-403-10	194-407-10
12,0 mm	194-402-12	194-406-12	194-403-12	194-407-12
15,0 mm	194-402-15	194-406-15	194-403-15	194-407-15
20,0 mm	194-402-20	194-406-20	194-403-20	194-407-20
22,0 mm	194-402-22	194-406-22	194-403-22	194-407-22
25,0 mm	194-402-25	194-406-25	194-403-25	194-407-25

Osteotome; Flachmeißel; Hohlmeißel
 Osteotomes; Chisels; Gouges
 Osteótomos; Cinceles; Gubias

Art.Nr.	Beschreibung Description	Size	Spez.
194-430-18	Meißelgriff mit Schlüssel für auswechselbare Klingen Chisel handle with key for interchangeable blades Mango para hojas de cincel para hojas intercambiables	18,5cm; 7 2/8"	FERROZELL

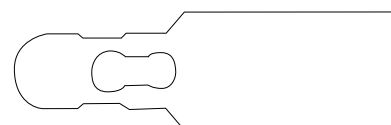

194-430-01	Spannschlüssel Key llave
------------	--------------------------------



Osteotomklinge
 Osteotome blade
 Hojas de osteótomo

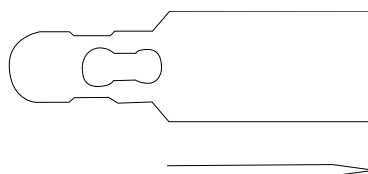

194-431-05	5,0 mm	
------------	--------	--

194-431-10	10,0 mm	
------------	---------	--

194-431-16	16,0 mm	
------------	---------	--

194-431-25	25,0 mm	
------------	---------	--

Osteotome; Flachmeißel; Hohlmeißel
 Osteotomes; Chisels; Gouges
 Osteótomos; Cinceles; Gubias



Art.Nr. Beschreibung | Description Size Spez.

Flachmeißelklinge
 Chisel blade
 Hojas de cincel

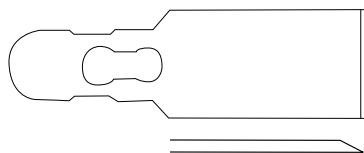

194-432-05

5,0 mm



194-432-16

16,0 mm



194-432-10

10,0 mm



194-432-25

25,0 mm

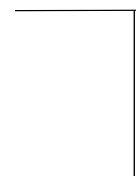

Hohlmeißelklinge
 Gouge blades
 Hojas de gubia



194-433-50

25,0 mm

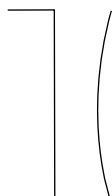

r= 50,0 mm

194-433-60

25,0 mm



r= 60,0 mm

194-433-70

25,0 mm

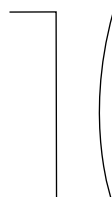

r= 70,0 mm

194

Osteotome; Flachmeißel; Hohlmeißel
 Osteotomes; Chisels; Gouges
 Osteótomos; Cinceles; Gubias

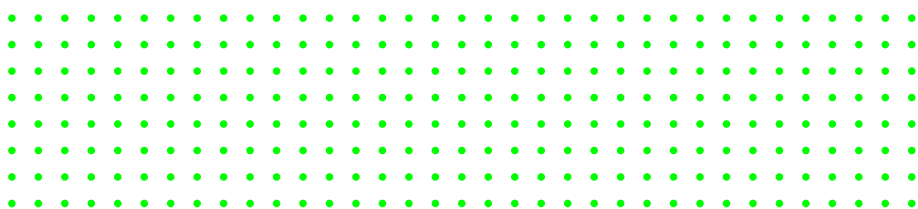

Art.Nr.	Beschreibung Description	Size	Spez.
---------	----------------------------	------	-------

MINI-LAMBOTTE

12,5cm; 4 7/8"

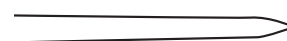

194-446-02	2,0 mm		194-446-08	8,0 mm	
194-446-03	3,0 mm		194-446-10	10,0 mm	
194-446-04	4,0 mm		194-446-12	12,0 mm	
194-446-06	6,0 mm		194-446-15	15,0 mm	

MINI-LAMBOTTE

17,0cm; 6 6/8"

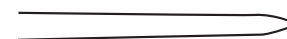

194-448-03	3,0 mm		194-448-10	10,0 mm	
194-448-04	4,0 mm		194-448-12	12,0 mm	
194-448-06	6,0 mm		194-448-15	15,0 mm	
194-448-08	8,0 mm				

Osteotome; Flachmeißel; Hohlmeißel
 Osteotomes; Chisels; Gouges
 Osteótomos; Cinceles; Gubias



Art.Nr.	Beschreibung Description	Size	Spez.
---------	----------------------------	------	-------

LAMBOTTE

24,0cm; 9 4/8"

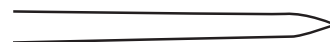

194-450-04	4,0 mm	
------------	--------	--

194-450-06	6,0 mm	
------------	--------	--

194-450-15	15,0 mm	
------------	---------	--

194-450-44 44,0 mm

194-450-20	20,0 mm	
------------	---------	--

194-450-25	25,0 mm	
------------	---------	--

194-450-30	30,0 mm	
------------	---------	--

194-450-50 50,0 mm

194-450-38	38,0 mm	
------------	---------	--

194

Osteotome; Flachmeißel; Hohlmeißel
 Osteotomes; Chisels; Gouges
 Osteótomos; Cinceles; Gubias

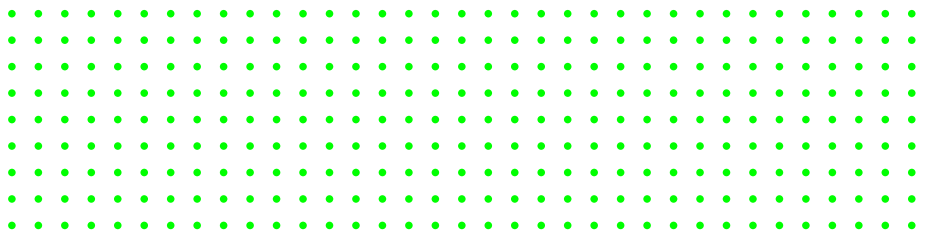

Art.Nr.	Beschreibung Description	Size	Spez.
	LAMBOTTE	24,0cm; 9 4/8"	



194-451-04	4,0 mm	
------------	--------	--

194-451-06	6,0 mm	
------------	--------	--

194-451-15	15,0 mm	
------------	---------	--

194-451-44 44,0 mm

194-451-20	20,0 mm	
------------	---------	--

194-451-25	25,0 mm	
------------	---------	--

194-451-30	30,0 mm	
------------	---------	--

194-451-50 50,0 mm

194-451-38	38,0 mm	
------------	---------	--

Weitere Artikel
further items
más artículos

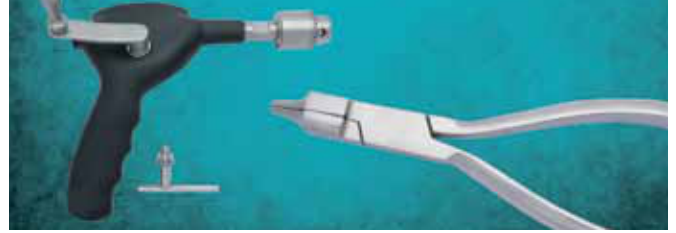

Art.Nr.	Beschreibung Description	Size	Spez.
Other items available but not illustrated			
194-306-00/SET	HOKE Osteotome Set/ 6 pieces; straight; sizes 3,4,5,6,8,10,12mm	14,0cm; 5,6"	
194-306-10	HOKE Osteotome straight; 10,0mm; hexagonal handle	14,0cm; 5,6"	
194-306-12	HOKE Osteotome straight; 12,0mm; hexagonal handle		
194-307-00/SET	HOKE Osteotomee Set/ 6 pieces; curved; sizes 3,4,5,6,8,10,12mm	14,0cm; 5,6"	
194-307-10	HOKE Osteotome curved; 10,0mm; hexagonal handle	14,0cm; 5,6"	
194-307-12	HOKE Osteotome curved; 12,0mm; hexagonal handle		
194-310-04	LUCAS Chisel straight; 4mm	16,0cm; 6,4"	
194-310-06	LUCAS Chisel straight; 6mm		
194-312-03	LUCAS Chisel straight; 3mm		
194-312-05	LUCAS Chisel straight; 5mm		
194-334-07	PARTSCH Chisel straight; 7,0mm	13,5cm; 5,4"	
194-334-08	PARTSCH Chisel straight; 8,0mm		
194-336-07	PARTSCH Gouge straight; 7,0mm	13,5cm; 5,4"	
194-336-08	PARTSCH Gouge straight; 8,0mm		
194-338-07	PARTSCH Chisel straight; 7,0mm	17,0cm; 6,8"	
194-338-08	PARTSCH Chisel straight; 8,0mm		
194-340-07	PARTSCH Gouge straight; 7,0mm	17,0cm; 6,8"	
194-340-08	PARTSCH Gouge straight; 8,0mm		
194-342-28	HIBBS Chisel; straight; 28,0mm; hexagonal handle	24,0cm; 9,6"	
194-351-06	SMITH-PETERSEN osteotome; curved; 6,0mm	20,0cm; 8"	
194-352-06	SMITH-PETERSEN gouge; straight; 6,0mm	20,0cm; 8"	
194-360-08	STILLE Chisel; straight; 8,0mm	20,0cm; 8"	
194-361-04	STILLE Osteotome straight; 4,0mm	20,0cm; 8"	
194-361-06	STILLE Osteotome straight; 6,0mm		
194-362-08	STILLE Gouge straight; 8,0mm	20,0cm; 8"	
194-363-08	STILLE Gouge curved; 8,0mm		

Weitere Artikel
further items
más artículos

Art.Nr.	Beschreibung Description	Size	Spez.
Other items available but not illustrated			
194-363-10	STILLE Gouge curved; 10,0mm	20,0cm; 8"	
194-363-15	curved; 15,0mm		
194-363-20	curved; 20,0mm		
194-363-25	curved; 25,0mm		
194-370-15	MINI-LEXER Osteotome straight; 15,0mm; wooden handle	18,0cm; 7,2"	
194-370-20	straight; 20,0mm; wooden handle		
194-372-15	MINI-LEXER Gouge straight; 15,0mm; wooden handle	18,0cm; 7,2"	
194-372-20	straight; 20,0mm; wooden handle		
194-374-12	LEXER osteotome; straight; 12,0mm; wooden handle	22,0cm; 8,8"	
194-402-30	DAHMEN osteotome; straight; 30,0mm; wooden handle	30,0cm; 12"	
194-404-04	DAHMEN Chisel straight; 4,0mm; wooden handle	30,0cm; 12"	
194-404-05	straight; 5,0mm; wooden handle		
194-404-06	straight; 6,0mm; wooden handle		
194-404-08	straight; 8,0mm; wooden handle		
194-404-10	straight; 10,0mm; wooden handle		
194-404-12	straight; 12,0mm; wooden handle		
194-404-15	straight; 15,0mm; wooden handle		
194-404-20	straight; 20,0mm; wooden handle		
194-404-22	straight; 22,0mm; wooden handle		
194-404-25	straight; 25,0mm; wooden handle		
194-404-30	straight; 30,0mm; wooden handle		
194-405-04	curved; 4,0mm; wooden handle		
194-405-05	curved; 5,0mm; wooden handle		
194-405-06	curved; 6,0mm; wooden handle		
194-405-08	curved; 8,0mm; wooden handle		
194-405-10	curved; 10,0mm; wooden handle		
194-405-12	curved; 12,0mm; wooden handle		
194-405-15	curved; 15,0mm; wooden handle		
194-405-20	curved; 20,0mm; wooden handle		
194-405-22	curved; 22,0mm; wooden handle		
194-405-25	curved; 25,0mm; wooden handle		
194-405-30	curved; 30,0mm; wooden handle		
194-410-10	Chisel straight; 10,0mm; wooden handle	16,0cm; 6,4"	
194-410-15	straight; 15,0mm; wooden handle		
194-412-10	Chisel straight; 10,0mm; wooden handle	20,0cm (8")	
194-412-15	straight; 15,0mm; wooden handle		
194-412-20	straight; 20,0mm; wooden handle		

Weitere Artikel
further items
más artículos

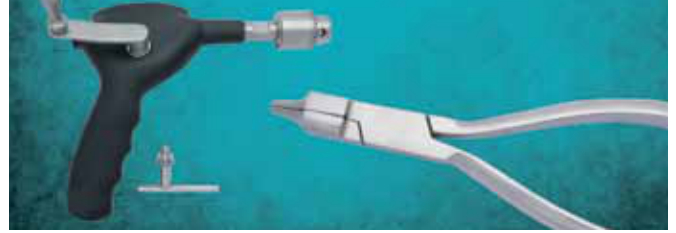

Art.Nr.	Beschreibung Description	Size	Spez.
Other items available but not illustrated			
194-413-10	1 Chisel curved; 10,0mm; wooden handle	20,0cm; 8"	
194-413-15	curved; 15,0mm; wooden handle		
194-413-20	curved; 20,0mm; wooden handle		
194-414-24	Chisel straight; 20,0mm; wooden handle	24,5cm; 8,8"	
194-415-26	curved; 16,0mm; wooden handle	26,5cm; 10,6"	
194-420-22	Gouge for removing broken screws; straight; 22,0mm; wooden handle	22,0cm; 8,8"	
194-423-05	ZIELKE Gouge curved; 5,5mm; wooden handle	23,0cm; 9,2"	
194-423-09	curved; 9,0mm; wooden handle		
194-448-07	MINI-LAMBOTTE osteotome; straight; 7,0mm	17,0cm; 6,8"	
194-450-08	LAMBOTTE Osteotome straight; 8,0mm	24,0cm; 9,6	
194-450-10	straight; 10,0mm		
194-450-13	straight; 13,0mm		
194-450-18	straight; 18,0mm		
194-451-08	curved; 8,0mm		
194-451-10	curved; 10,0mm		
194-451-13	curved; 13,0mm		
194-451-18	curved; 18,0mm		
194-500-05	CHAMPY bone biopsy instrument; Ø 5,0mm; complete with trocar sleeve trephine and plunger		
194-501-01	CHAMPY, trocar sleeve only; Ø 5,0mm		
194-501-02	CHAMPY, biopsy threphine only; Ø 5,0mm		
194-501-03	CHAMPY, obturator only, blunt; Ø 5,0mm		
194-510-08	CHAMPY bone biopsy instrument; Ø 8,0mm; complete with trocar sleeve trephine and plunger		
194-511-01	CHAMPY, trocar sleeve only; Ø 8,0mm		
194-511-02	CHAMPY, biopsy threphine only; Ø 8,0mm		
194-511-03	CHAMPY, obturator only, blunt; Ø 8,0mm		



hand drills

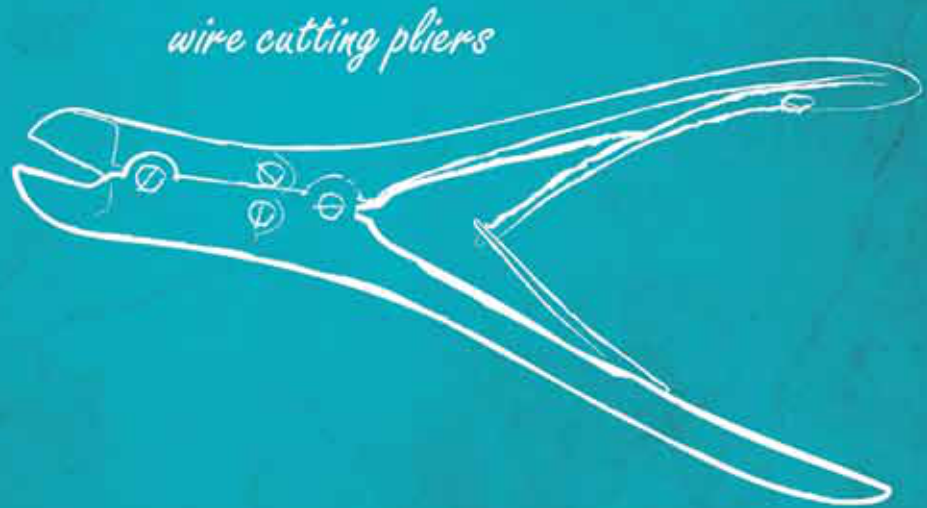

wire cutting pliers

195

Knochenhalteklammern; Repositionszangen
 Bone Holding Clamps; Reposition Forceps
 Grapas porta-huesos; Pinzas para reposición

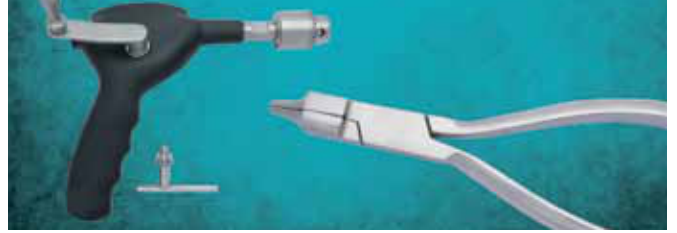

Art.Nr.	Beschreibung Description	Size	Spez.
---------	----------------------------	------	-------

GERSTER-LOWMAN



- 195-102-12 18,0cm; 7"
- 195-102-18 20,0cm; 8"
- 195-102-21 22,0cm; 8 6/8"

195-110-00	GERSTER Distractionsklammer traction bar barra de tracción	15,0cm; 5 7/8"	
------------	--	----------------	--



195-128-13		13,5cm; 5,4"	
------------	--	--------------	--



195-130-14		14,0cm; 5 4/8"	
------------	--	----------------	--

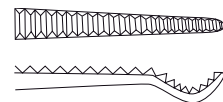

195

Knochenhaltezangen
 Bone holding forceps
 Pinzas para hueso

Art.Nr. Beschreibung | Description Size Spez.

195-132-14



14,5cm; 5 6/8"

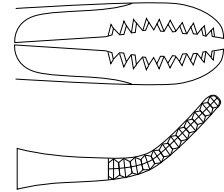

195-140-13

lange Sperre
 long catch
 cremallera larga



13,5cm; 5 3/8"



195-141-23

VAN BUREN





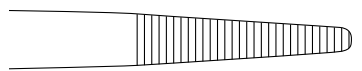

23,0cm; 9"

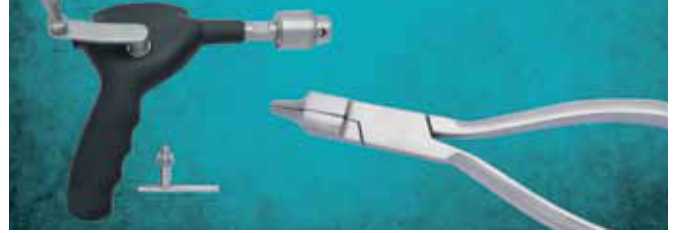

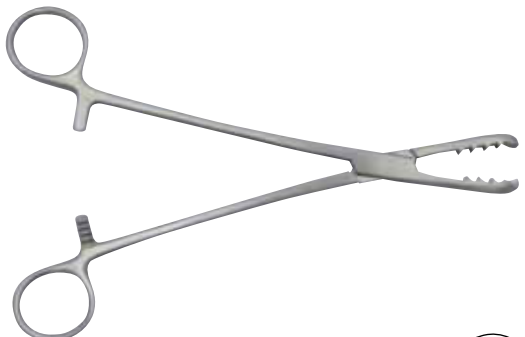
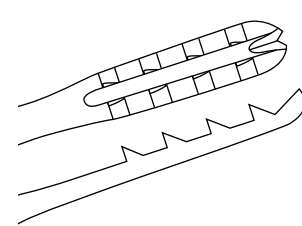
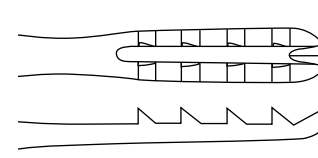
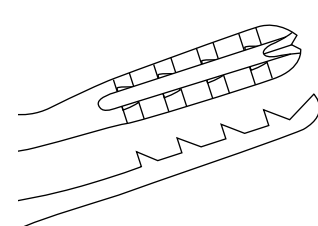
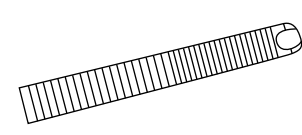
Knorpelfasszangen
 Cartilage seizing forceps
 Pinzas para cartilago

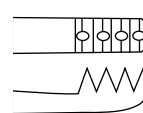

Art.Nr.	Beschreibung Description	Size	Spez.
	BIRCHER-GANSKE	20,0cm; 7 7/8"	
			
195-143-20	seitwärts gebogen curved sideways curva lateralmente 		
195-144-20	gerade straight recta 		
195-145-20	aufgebogen curved upwards curva por arriba 		
195-147-19	DINGMANN	18,5cm; 7 2/8"	
			
195-154-19	MARTIN	18,5cm; 7 2/8"	
			

195

Knochenhaltezangen
 Bone holding forceps
 Pinzas para hueso

Art.Nr.	Beschreibung Description	Size	Spez.
---------	----------------------------	------	-------

195-161-17

LEWIN

18,0cm; 7 1/8"

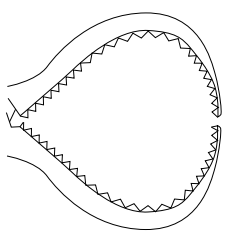
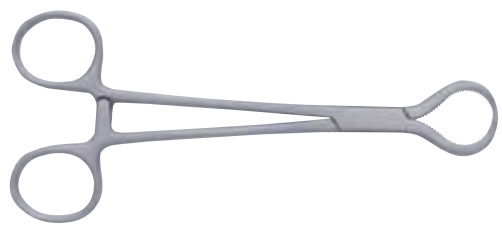

195-163-17

mit Gewindesperre
 with thread fixation
 con cremallera de ros

17,5cm; 6 7/8"

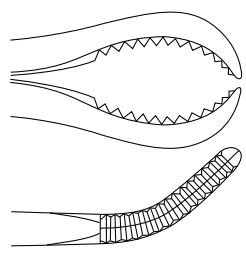

195-163-24

mit Gewindesperre
 with thread fixation
 con cremallera de ros

24,0cm; 9 4/8"

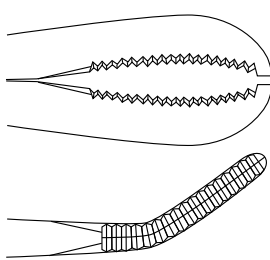

Knochenhaltezangen
 Bone holding forceps
 Pinzas para hueso

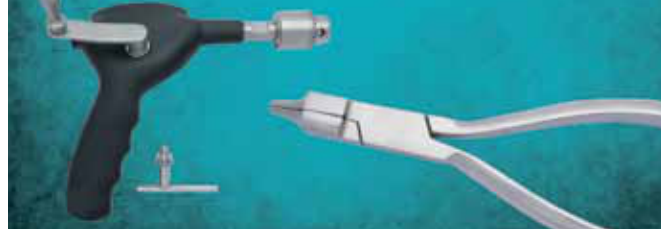

Art.Nr.	Beschreibung Description	Size	Spez.
---------	----------------------------	------	-------

195-174-21	FERGUSSON	21,0cm; 8 2/8"	
------------	-----------	----------------	--



195-176-21	LANGENBECK	21,0cm; 8 2/8"	
------------	------------	----------------	--



195-178-20		20,0cm; 7 7/8"	
------------	--	----------------	--

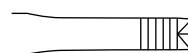

195-182-17	KERN	17,0cm; 6 6/8"	
------------	------	----------------	--

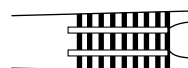

195-182-21	KERN	21,0cm; 8 1/4"	
------------	------	----------------	--

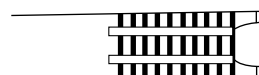

195

Knochenhaltezangen
 Bone holding forceps
 Pinzas para hueso

Art.Nr.	Beschreibung Description	Size	Spez.
---------	----------------------------	------	-------

195-187-19

SEMB

19,5cm; 7 5/8"

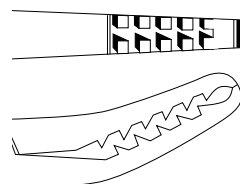

195-190-33

LANE mit Sperre
 with catch
 con cremallera

33,0cm; 13"

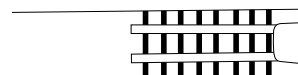

195-192-33

LANE ohne Sperre
 without catch
 sin cremallera

33,0cm; 13"

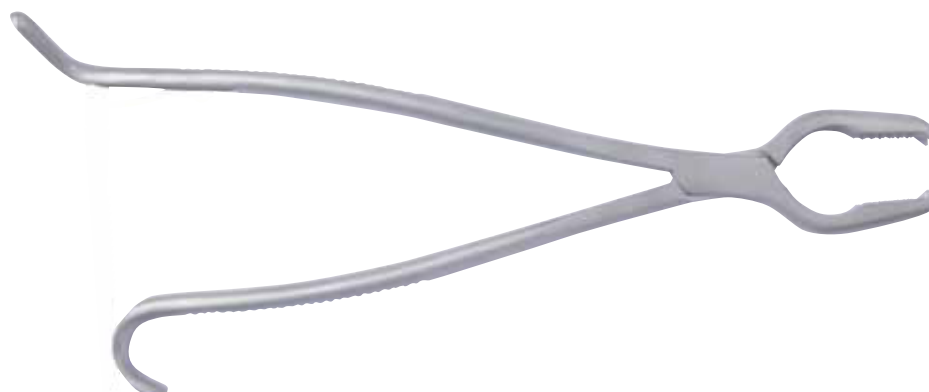

Knochenhalte­zangen
 Bone holding forceps
 Pinzas para hueso

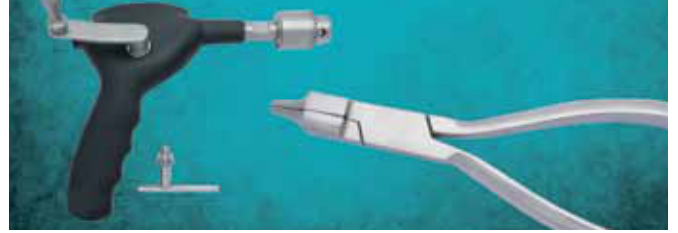

Art.Nr.	Beschreibung Description	Size	Spez.
195-202-26	FARABEUF	26,0cm; 10 2/8"	

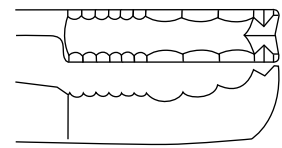

195-206-23	FARABEUF	23,0cm; 9"	
------------	----------	------------	--

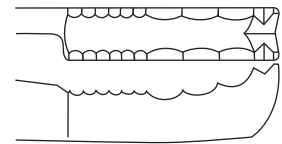

195-206-26	FARABEUF	26,0cm; 10 2/8"	
------------	----------	-----------------	--

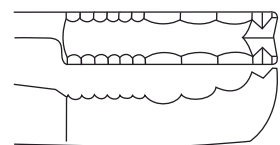

195

Knochenhalte­zangen
 Bone holding forceps
 Pinzas para hueso

Art.Nr. Beschreibung | Description Size Spez.

VERBRUGGE

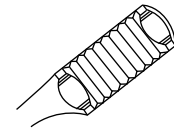

195-211-17 17,5cm; 6 7/8"

195-211-25 25,0cm; 9 7/8"

195-211-26 26,0cm; 10 2/8"

195-211-27 27,0cm; 10 7/8"

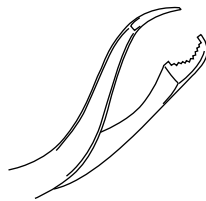

195-217-19 LAMBOTTE

19,0cm; 7 4/8"

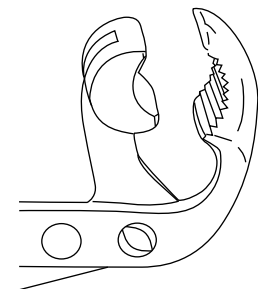

Knochenhaltezangen
 Bone holding forceps
 Pinzas para hueso



Art.Nr.	Beschreibung Description	Size	Spez.
---------	----------------------------	------	-------

LAMBOTTE



195-218-22 22,0cm; 8 5/8"

195-218-27 27,0cm; 10 5/8"

195-218-30 30,0cm; 11 6/8"

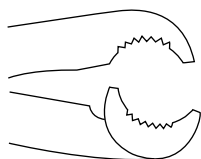

mit Gewindesperre
 with thread fixation
 con cremallera de ros

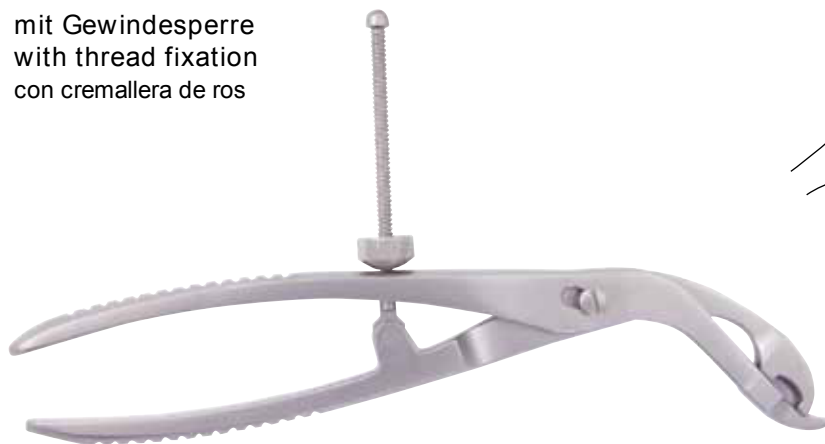
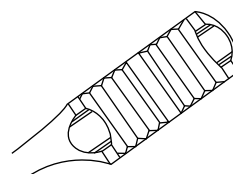

195-221-15 15,0cm; 5 7/8"

195-221-19 20,0cm; 7 7/8"

195-221-24 24,0cm; 9 4/8"

195-221-26 26,0cm; 10 2/8"

195-221-28 28,0cm; 11"

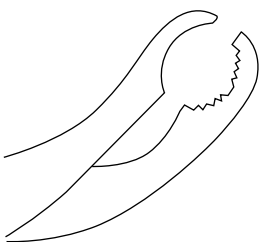

195

Knochenhalte­zangen
 Bone holding forceps
 Pinzas para hueso

Art.Nr.	Beschreibung Description	Size	Spez.
---------	----------------------------	------	-------

ULRICH mit Gewindesperre
 with thread fixation
 con cremallera de ros



195-225-23	23,0cm; 9"		
------------	------------	--	--

195-225-25	25,0cm; 9 7/8"		
------------	----------------	--	--

195-225-28	28,0cm; 11"		
------------	-------------	--	--

gebogen | curved | curva

195-226-23	23,0cm; 9"		
------------	------------	--	--

195-226-25	25,0cm; 9 7/8"		
------------	----------------	--	--

195-226-28	28,0cm; 11"		
------------	-------------	--	--

gerade | straight | recta

Sehneneinf echt klemmen; Sehnendurchziehzangen
 Tendon interlacing forceps; Tendon holding forceps
 Pinza para entrelazar tendones; Pinzas para coger tendones

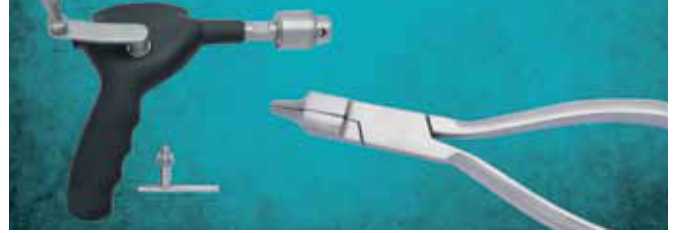

Art.Nr.	Beschreibung Description	Size	Spez.
---------	----------------------------	------	-------

15,0cm; 5 7/8"



195-234-15



195-235-15

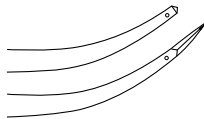

20,5cm; 8 1/8"

 2x3



195-238-20











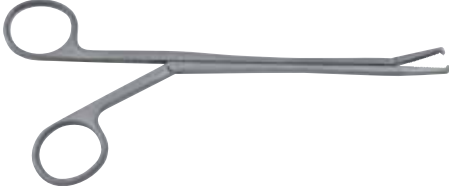

195-239-20

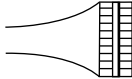

195

Sehnenfazzangen
Tendon holding forrceps
Pinzas para coger tendones

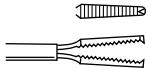
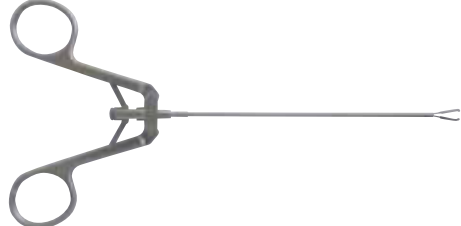
Art.Nr.	Beschreibung Description	Size	Spez.
	BRAND		
			
195-241-15	15,0cm; 5 7/8"  2x3		
195-241-19	19,0cm; 7 4/8"  2x3		
195-241-24	24,5cm; 9 5/8"  2x3		
195-245-11	CARROLL	11,5cm; 4 4/8"	
			
195-246-16	STEINMANN	16,0cm; 6 2/8"	
			
195-248-20	KLEINERT-KUTZ	21,0cm; 8 2/8" 2,0 mm  1x2	
			

Sehnenfazzangen; Sehnenstripper
 Tendon holding forrceps; tendon strippers
 Pinzas para coger tendones; enucleadores de tendones

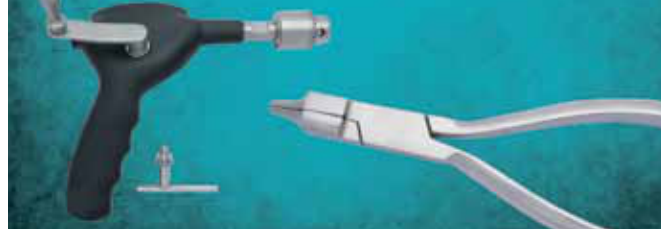

Art.Nr.	Beschreibung Description	Size	Spez.
195-252-11	mit Stellschraube with fixation screw con cremallera de rosca	11,5cm; 4 4/8"	



195-260-23	BUNNELL	23,0cm; 9" Ø 5,0 mm	
------------	---------	------------------------	--



195-262-31	FISCHER	31,0cm; 12 2/8" Ø 4,0 mm	
------------	---------	-----------------------------	--



Sehnenstripper
Tendon strippers
Enucleadores de tendones

Art.Nr.	Beschreibung Description	Size	Spez.
195-264-33	biegsam flexible flexible	33,5cm; 13 2/8" Ø 5,5 mm	

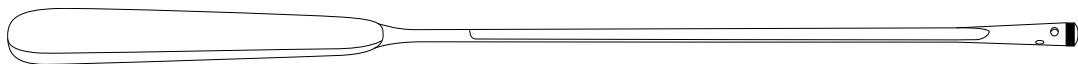

195-264-01	Schraube allein srew only tornillo solo	Ø 5,5 mm	
------------	---	----------	--



	biegsam flexible flexible	23,0cm; 9"	
--	---------------------------------	------------	--



195-265-04	Ø 4,0 mm	○
195-265-05	Ø 5,0 mm	○
195-265-06	Ø 6,0 mm	○

	BUNNELL	15,0cm; 5 7/8"	
--	---------	----------------	--



195-268-01	Fig. 1	Ø 3,0 mm	○
195-268-02	Fig. 2	Ø 4,0 mm	○
195-268-03	Fig. 3	Ø 5,0 mm	○
195-268-04	Fig. 4	Ø 6,0 mm	○
195-268-05	Fig. 5	Ø 7,0 mm	○

Kniehaken; Meniskusmesser
 Knee retractor; Meniscus knife
 Separadores para rodilla; Cuchillos para menisco

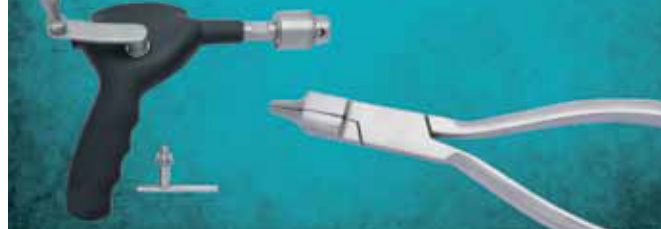

Art.Nr.	Beschreibung Description	Size	Spez.
---------	----------------------------	------	-------

195-274-17	BLOUNT spitz sharp agudo	17,5cm; 6 7/8"	
------------	--------------------------	----------------	--



SMILLIE

17,5cm; 6 7/8"



195-278-01

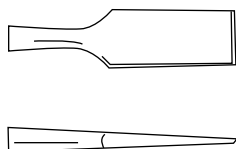

195-278-02

Schutz links
 protection left
 protección a la izquierda

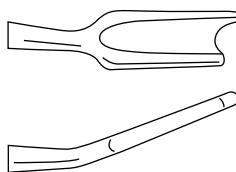

195-278-03

Schutz rechts
 protection right
 protección a la derecha

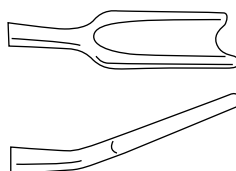

195

Meniskusmesser
 Meniscus knife
 Cuchillos para menisco

Art.Nr.	Beschreibung Description	Size	Spez.
	SALENIUS	21,5cm; 8 4/8"	



195-280-01 Fig. 1



195-280-02 Fig. 2

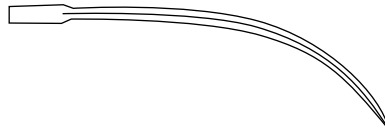

NEFF

22,0cm; 8 5/8"



195-282-01 Fig. 1



195-282-02 Fig. 2



195-284-17 NEFF

17,5cm; 6 7/8"



Weitere Artikel
further items
más artículos

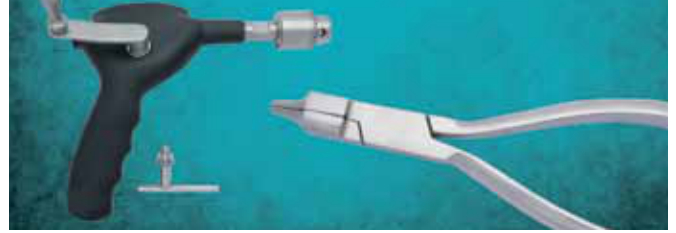

Art.Nr.	Beschreibung Description	Size	Spez.
Other items available but not illustrated			
	LOWMANN bone holding forceps		
195-101-12		12,0cm; 4,8"	
195-101-18		18,0cm; 7,2"	
195-101-21		21,0cm; 8,4"	
	LOWMAN-LAMBERT bone holding clamp		
195-104-21		21,0cm; 8,4"	
195-105-18	1 jaw swiveld	18,0cm; 7,2"	
195-129-13	reposition forceps; for small fragments	13,5cm; 5,4"	
	bone holding forceps		
195-131-13		13,5cm; 5,4"	
195-134-12		12,0cm; 4,8"	
195-136-20	reposition forceps; long ratchet, 20,5cm	20,5cm; 8,2"	
195-138-20	bone holding forceps; straight	20,0cm; 8"	
195-139-20	bone holding forceps; curved	20,0cm; 8"	
195-149-19	DINGMANN cartilage forceps	19,0cm; 7,6"	
195-152-16	MARTIN meniscus forceps	16,5cm; 6,6"	
195-154-21	MARTIN cartilage forceps	20,5cm; 8,2"	
195-157-13	cartilage forceps	13,5cm; 5,4"	
195-158-21	bone holding forceps	21,0cm; 8,4"	
195-160-17	CHANDLER bone holding forceps; straight	17,5cm; 7"	
195-165-16	bone holding forceps	16,0cm; 6,4"	
195-165-24	bone holding forceps	24,0cm; 9,6"	
195-168-18	patella forceps	18,5cm; 7,4"	
	KERN bone holding forceps		
195-180-17	without ratchet	17,0cm; 6,8"	
195-180-21	without ratchet	21,0cm; 8,4"	
195-182-15	with ratchet	15,5cm; 6,2"	
195-185-19	SEMB bone holding forceps; with ratchet, 19,0cm	19,0cm; 7,6"	
195-192-45	LANE bone holding forceps; without ratchet	45,0cm; 18"	

195

Weitere Artikel
further items
más artículos

Art.Nr.	Beschreibung Description	Size	Spez.
Other items available but not illustrated			
195-216-22	LAMBOTTE bone holding forceps straight	22,0cm; 8,8"	
195-216-26	straight	26,0cm; 10,4"	
195-216-33	straight	33,0cm; 13,2"	
195-217-23	curved	23,0cm; 9,2"	
195-217-26	curved	26,0cm; 10,4"	
195-226-18	ULRICH bone holding forceps; straight	18,0cm; 7,2"	
195-243-15	BRAND tendon seizing forceps curved	15,5cm; 6,2"	
195-243-19	curved	19,0cm; 7,6"	
195-243-24	curved	24,0cm; 9,6"	
195-248-25	KLEINERT-KUTZ tendon seizing forceps; 2,5mm, jaw 9mm	20,0cm; 8"	
195-250-15	JACKSON tendon seizing forceps; 4x5 teeth	15,5cm; 6,2"	
195-252-13	STEINMANN tendon seizing forceps; straight	13,0cm; 5,2"	
195-256-20	ANDERSON-BRAND tendon holding forceps straight	20,5cm; 8,2"	
195-257-15	curved	15,0cm; 6"	
195-257-20	curved	20,5cm; 8,2"	
195-257-25	curved	25,0cm; 10"	
195-258-01	HERZ tendon holding forceps small ring	15,5cm; 6,2"	
195-258-02	big ring		
195-263-50	BRAND tendon stripper	50,0cm; 20"	
195-263-51		30,0cm; 12"	
195-271-01	SMILLIE knee retractor 32x19mm		
195-271-02	48x19mm		
195-271-03	60x19mm		
195-271-04	55x13mm		
195-271-05	55x13mm		
195-272-17	knee retractor 56 X 10mm	17,0cm; 6,8"	
195-276-21	38 X 9mm	21,0cm; 8,4"	
195-286-01	BIRCHER meniscotomy figur 1		
195-286-02	figur 2		

Weitere Artikel
 further items
 más artículos

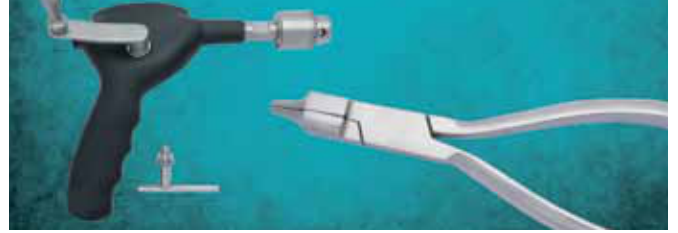

Art.Nr.	Beschreibung Description	Size	Spez.
Other items available but not illustrated			
195-288-01	CANAD. MODEL meniscus knife figur 1	20,5cm; 8,2"	
195-288-02	figur 2		
195-302-19	MENISCAL grasping forceps; 1x2 teeth, curved right	19,0cm; 7,6"	
195-608-15	WALTON-LISTON bone cutting forceps; straight, double action	14,5cm; 5,8"	



hand drills

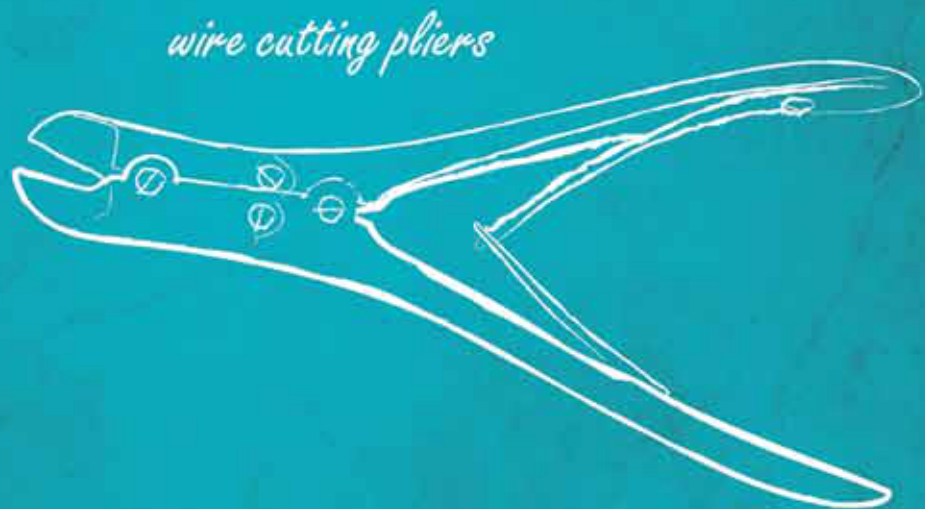

wire cutting pliers

Hohlmeißelzangen
Bone rongeurs

196

Hohlmeißelzangen
 Bone rongeurs
 Pinzas gubias

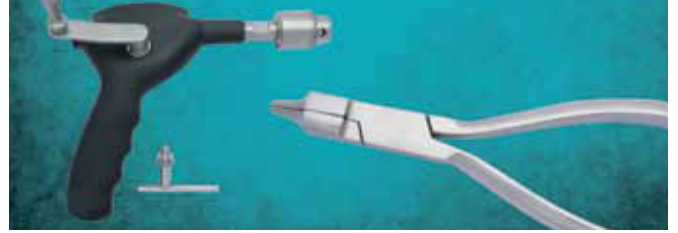

Art.Nr.	Beschreibung Description	Size	Spez.
196-201-12	FRIEDMANN	12,5cm; 4 7/8"	
196-201-14	FRIEDMANN	13,5cm; 5 3/8"	
196-203-14	FIEDMANN	13,5cm; 5 3/8"	
	STELLBRINK	17,0cm; 6 6/8"	
196-205-01			
		196-205-02	

196

Hohlmeißelzangen
 Bone rongeurs
 Pinzas gubias

Art.Nr.	Beschreibung Description	Size	Spez.
196-207-14	CLEVELAND	13,5cm; 5 3/8"	
196-207-17	CLEVELAND	16,5cm; 6 4/8"	
	JANSEN	18,0cm; 7 1/8"	

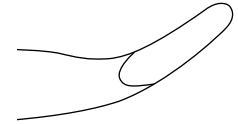

196-207-17 CLEVELAND

16,5cm; 6 4/8"

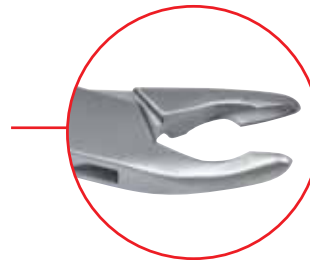

JANSEN

18,0cm; 7 1/8"

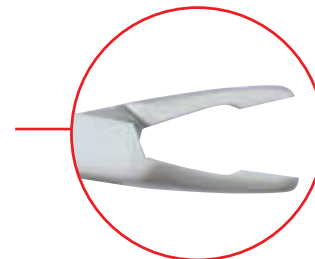
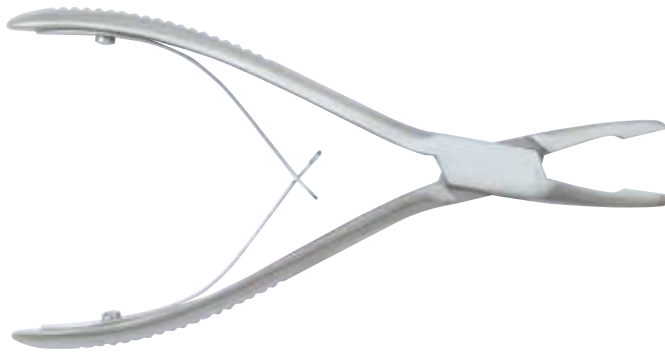

196-208-17

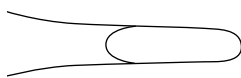

196-209-17

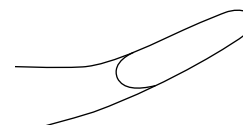

Hohlmeißelzangen
 Bone rongeurs
 Pinzas gubias

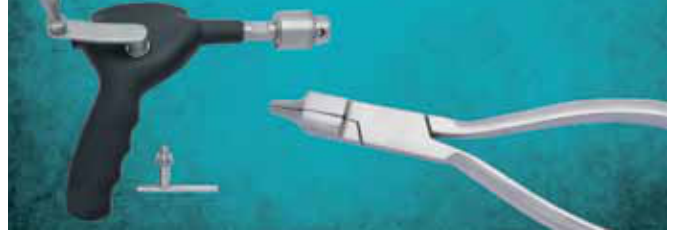

Art.Nr. Beschreibung | Description Size Spez.

15,5cm; 6 1/8"

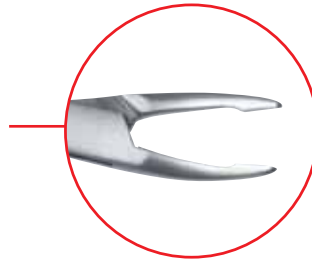
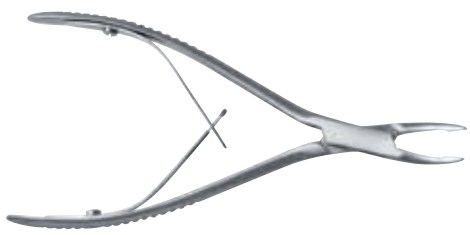

196-210-00



196-210-30

30°



196-210-90

90°

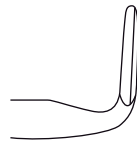

MEAD

16,5cm; 6 4/8"

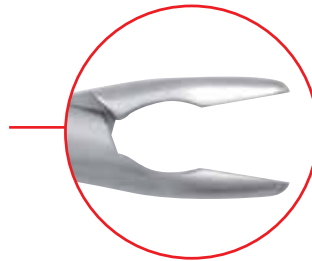

196-215-01

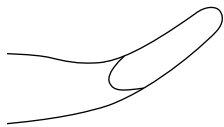

196-215-02



196-219-19

JANSEN

17,0cm; 6 6/8"

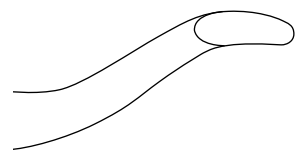

196

Hohlmeißelzangen
 Bone rongeurs
 Pinzas gubias

Art.Nr. Beschreibung | Description Size Spez.

196-221-18 HARTMANN 17,5cm; 6 7/8"

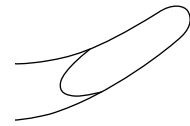

BLUMENTHAL

15,5cm; 6 1/8"

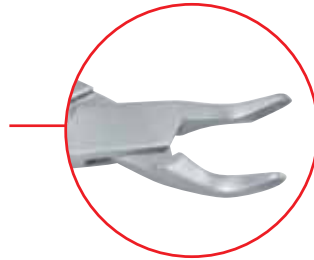

196-225-30

30°



196-225-45

45°

196-225-90

90°



LUER

18,0cm; 7 1/8"

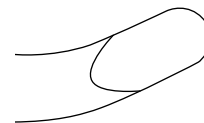
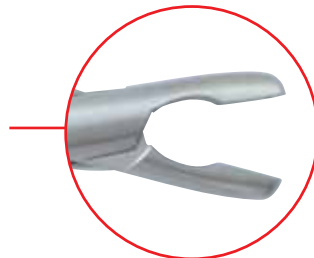

196-230-17

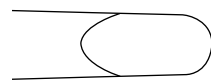

196-231-17

Hohlmeißelzangen
 Bone rongeurs
 Pinzas gubias



Art.Nr. Beschreibung | Description Size Spez.

LUER

14,5cm; 5 6/8"

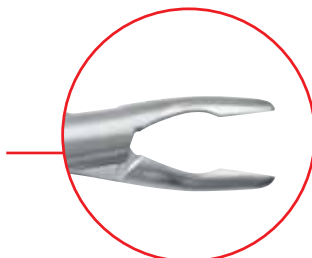
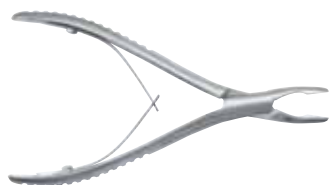

196-233-01

Fig.1



196-233-03

Fig.3

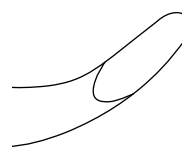

196-233-02

Fig.2



LEMPERT

19,0cm; 7 4/8"

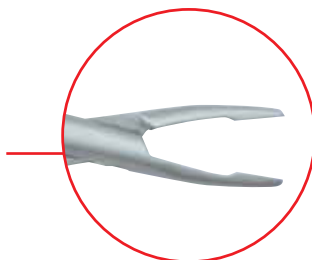
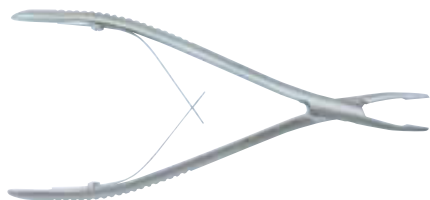

196-236-19

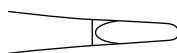

196-237-19

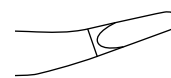

196-301-20

MARQUARDT

20,5cm; 8 1/8"

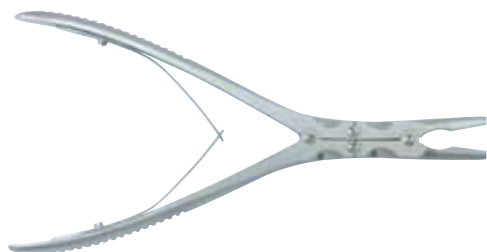

196-303-17

MAYFIELD

18,0cm; 7 1/8"

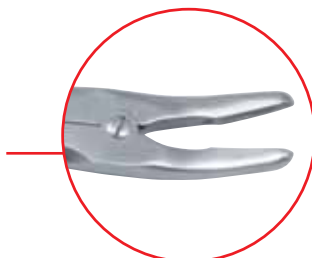
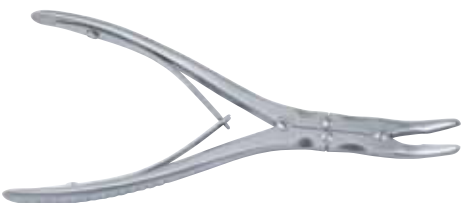

Hohlmeißelzangen
 Bone rongeurs
 Pinzas gubias

Art.Nr. Beschreibung | Description Size Spez.

BÖHLER

15,0cm; 5 7/8"



196-307-01



196-307-02



BEYER

18,0cm; 7 1/8"

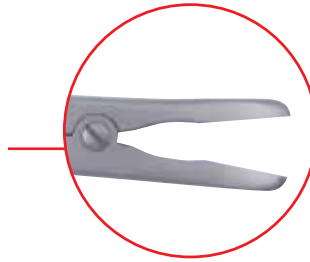

196-317-18



196-319-18



196-321-18

ZAUFAL-JANSEN

18,0cm; 7 1/8"

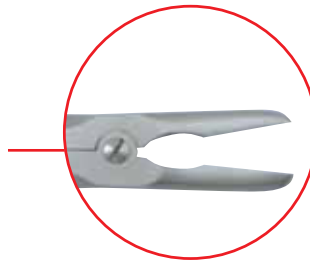

Hohlmeißelzangen
 Bone rongeurs
 Pinzas gubias



Art.Nr. Beschreibung | Description Size Spez.

RUSKIN

18,0cm; 7 1/8"

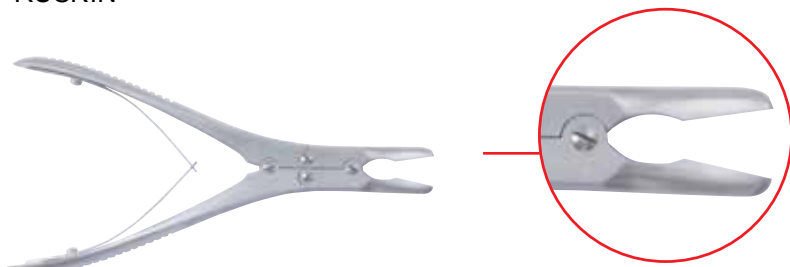

196-323-18

6 mm



196-324-18

6 mm



196-325-18

4 mm



196-326-18

4 mm



196-327-18

RUSKIN

18,0cm; 7 1/8"

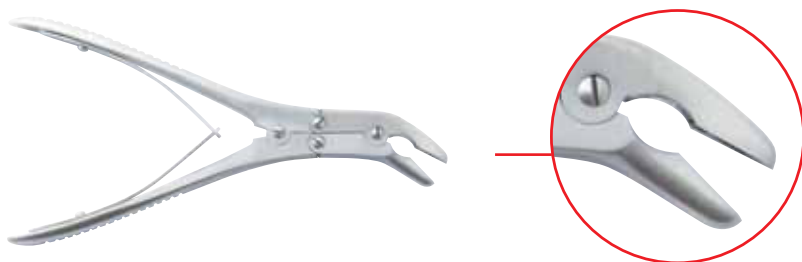

196

RUSKIN

20,5cm; 8 1/8"

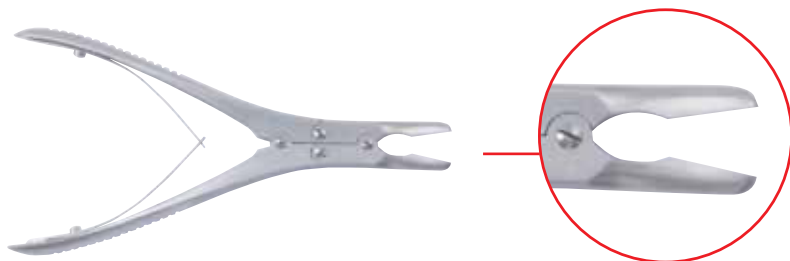

196-330-20

6 mm

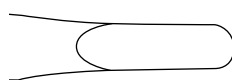

196-331-20

6 mm



Hohlmeißelzangen
 Bone rongeurs
 Pinzas gubias

Art.Nr.	Beschreibung Description	Size	Spez.
---------	----------------------------	------	-------

196-341-22

SEMB

22,5cm; 8 7/8"

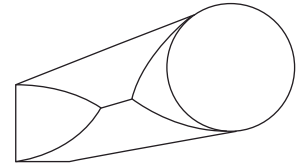

196-343-23

STILLE

22,5cm; 8 7/8"

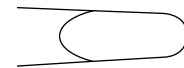

196-345-23

STILLE-RUSKIN

23,5cm; 9 2/8"

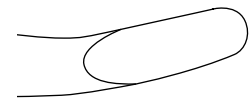
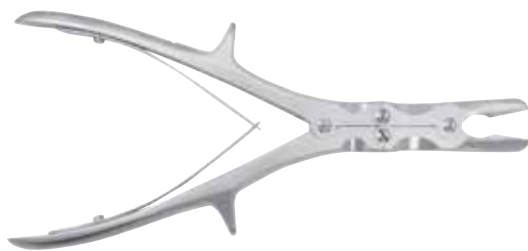

196-347-24

RUSKIN

24,0cm; 9 4/8"

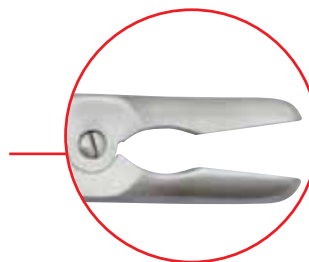

Hohlmeißelzangen
 Bone rongeurs
 Pinzas gubias

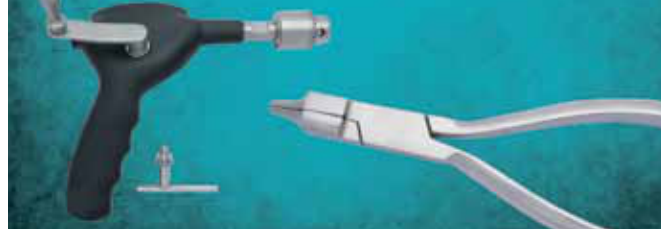

Art.Nr. Beschreibung | Description Size Spez.

LEKSELL-STILLE

24,5cm; 9 5/8"



196-349-04

4 mm



196-349-08

8 mm



STILLE-LUER



196-352-22

22,0cm; 8 5/8"

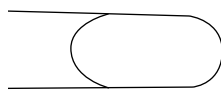

196-353-22

22,0cm; 8 5/8"

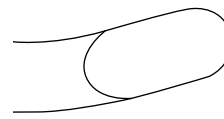

196-352-25

25,0cm; 9 7/8"



196-353-25

25,0cm; 9 7/8"



STILLE-LUER



196-354-22

23,0cm; 9"

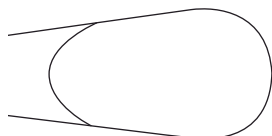

196-355-22

23,0cm; 9"



196-354-27

27,0cm; 10 5/8"



196-355-27

27,0cm; 10 5/8"



Art.Nr. Beschreibung | Description Size Spez.

SAUERBRUCH

31,0cm; 12 2/8"

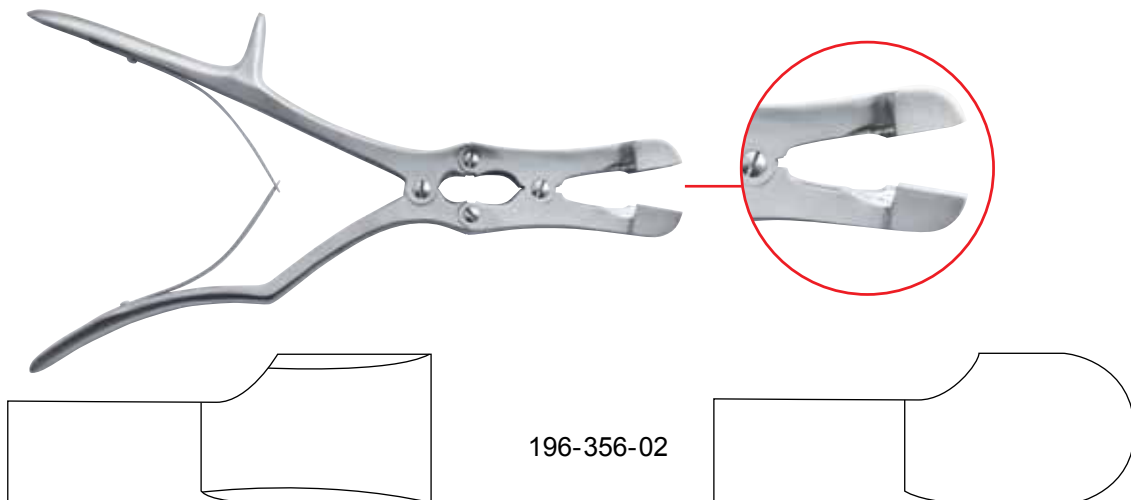

196-356-01

196-356-02

FRYKHOLM

24,0cm; 9 4/8"



196-357-04

4 mm



196-357-08

8 mm



ECHLIN

23,0cm; 9"



196-361-01

2 x 10 mm

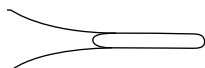

196-361-03

4 x 10 mm



196-361-02

3 x 10 mm



Knochensplitterzangen
 Bone Cutting Forceps
 Pinzas cortantes para hueso

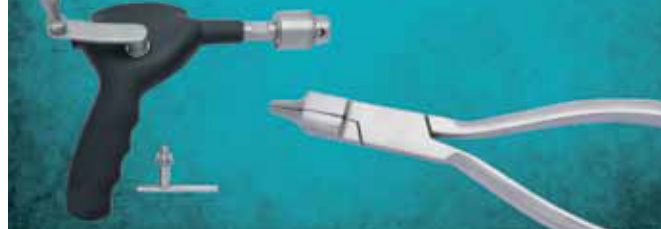

	Beschreibung Description	Size	Spez.
--	----------------------------	------	-------

196-500-19

KAZANJIAN

19,0cm; 7 4/8"

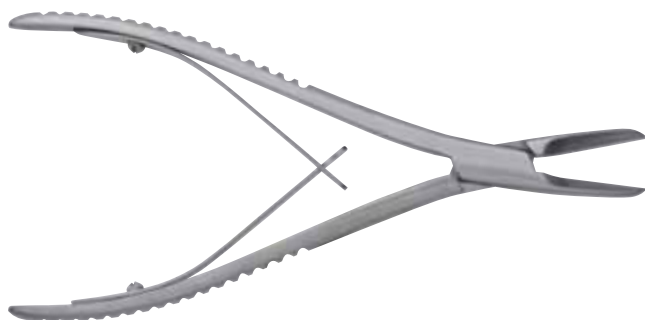

LISTON

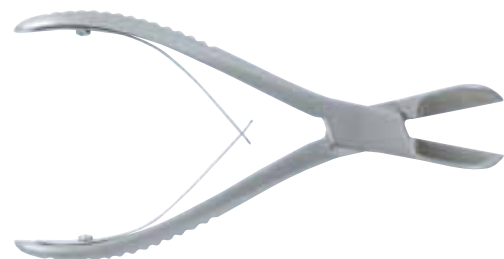

196-520-14

14,0cm; 5 4/8"

196-520-17

17,0cm; 6 6/8"

196-520-19

20,0cm; 7 7/8"

196-520-22

22,0cm; 8 5/8"



LISTON

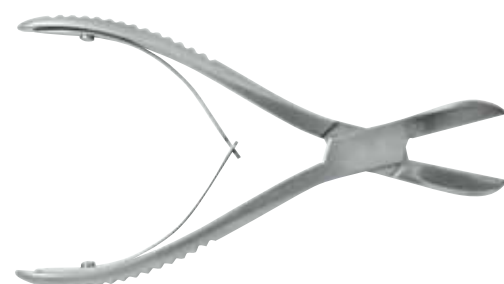

196-521-14

14,0cm; 5 4/8"

196-521-17

17,0cm; 6 6/8"

196-521-19







20,0cm; 7 7/8"

196-521-22

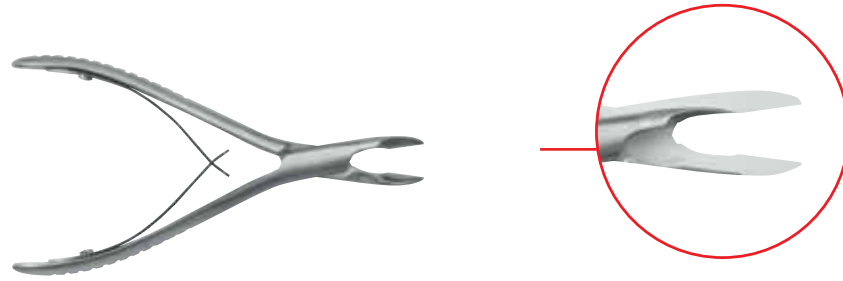
22,0cm; 8 5/8"

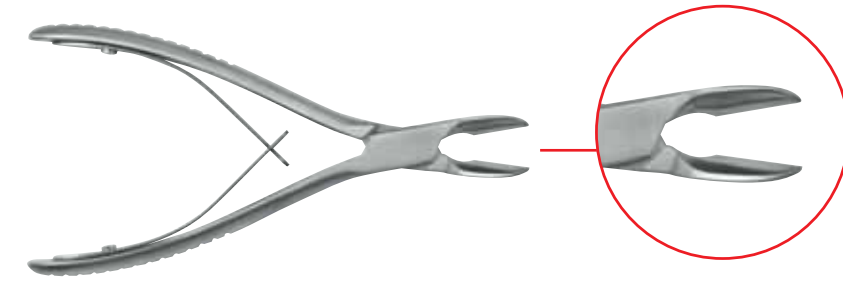

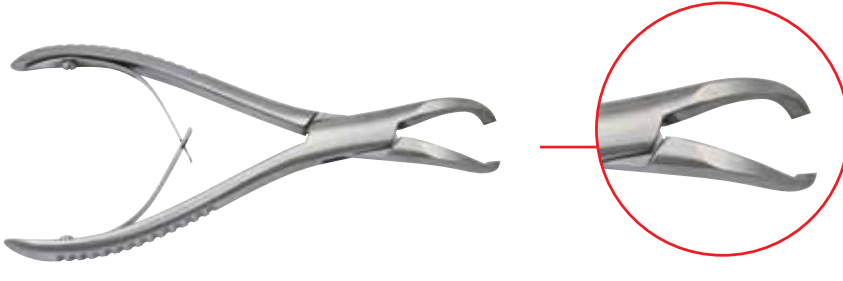
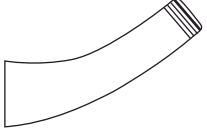
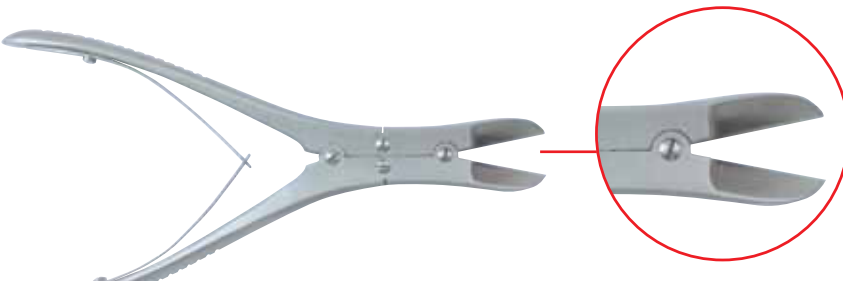

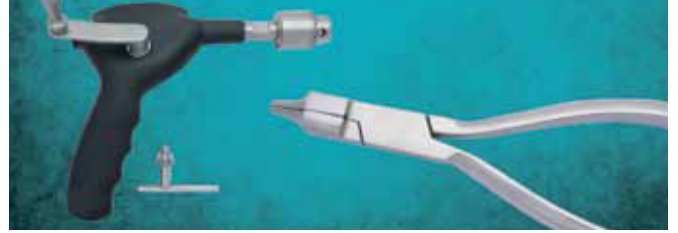

Knochensplitterzangen
 Bone Cutting Forceps
 Pinzas cortantes para hueso

Art.Nr.	Beschreibung Description	Size	Spez.
196-527-15	CLEVELAND	14,5cm; 5 6/8"	
			
196-527-17	CLEVELAND	17,0cm; 6 6/8"	
			
196-528-17	CLEVELAND	17,0cm; 6 6/8"	
			
196-602-18	RUSKIN-LISTON	18,5cm; 7 2/8"	
			

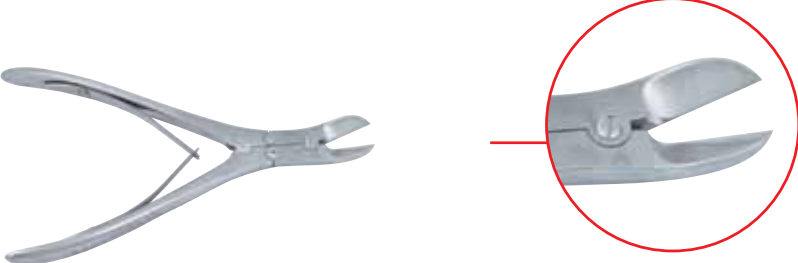
Knochensplitterzangen
 Bone Cutting Forceps
 Pinzas cortantes para hueso

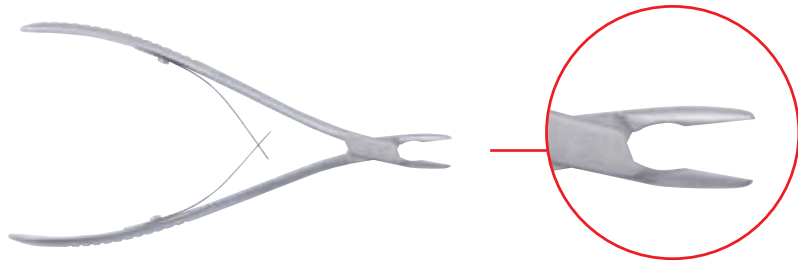

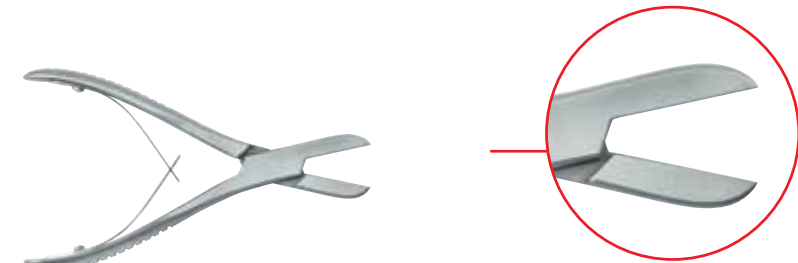
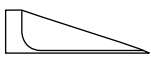
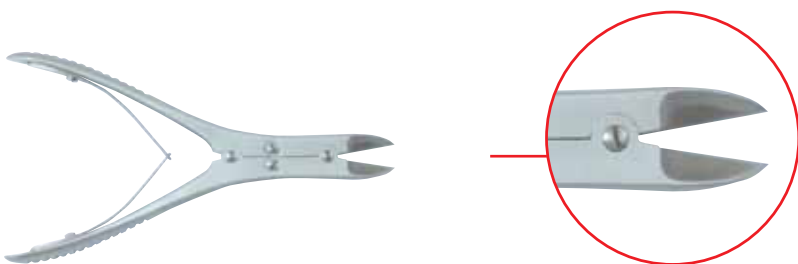
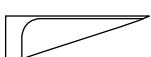
Art.Nr.	Beschreibung Description	Size	Spez.
196-603-18	RUSKIN-LISTON	18,5cm; 7 2/8"	
			
196-607-17	MC INDOE	17,5cm; 7"	
			
196-608-14	BÖHLER	14,5cm; 5 6/8" Fig. 1	
			
196-609-14	BÖHLER	14,5cm; 5 6/8" Fig.	
			

Knochensplitterzangen
 Bone Cutting Forceps
 Pinzas cortantes para hueso

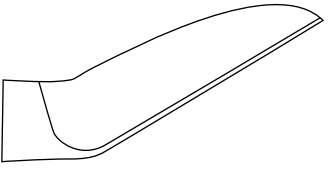
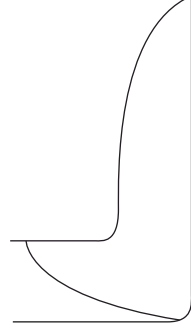
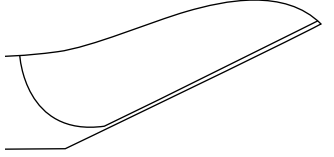
Art.Nr.	Beschreibung Description	Size	Spez.
196-620-27	LISTON-STILLE	28,0cm; 11"	
196-621-27	LISTON-STILLE	28,0cm; 11"	
196-623-27	LISTON-STILLE	26,0cm; 10 2/8"	
196-638-23	LISTON	23,5cm; 10 2/8"	

Knochensplitterzangen
 Bone Cutting Forceps
 Pinzas cortantes para hueso

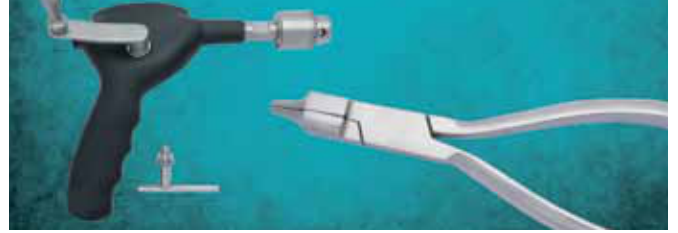

Art.Nr.	Beschreibung Description	Size	Spez.
196-633-24	SEMB	24,5cm; 9 5/8"	



196-627-27	LISTON-KEY	26,0cm; 10 2/8"	
------------	------------	-----------------	--

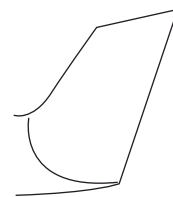

Bleihände
Lead Hands
Manoplas de plomo

Art.Nr.	Beschreibung Description	Size	Spez.
---------	----------------------------	------	-------



196-986-01 für Kinder
for children
para niños

196-986-02 für Erwachsene
for adults
para adultos

Silikonring; autoklavierbar
silicon ring; autoclavable
arandela de silicona; autoclavable

196-988-24 24x3 mm

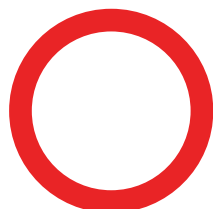

196-988-34 34x3 mm

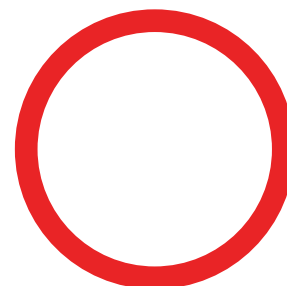

196-988-27 27x3 mm

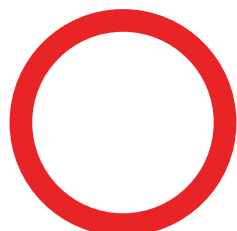

Weitere Artikel
further items
más artículos

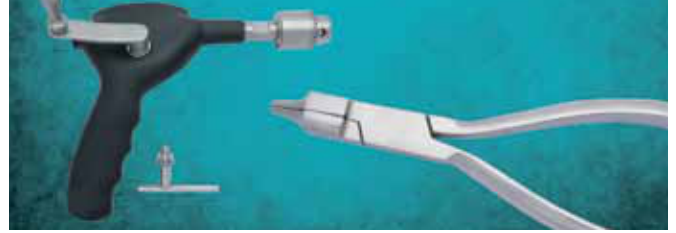

Art.Nr.	Beschreibung Description	Size	Spez.
Other items available but not illustrated			
196-203-20	ADSON bone rongeur; straight, 8mm	20,0cm; 8"	
196-204-15	MICRO-FRIEDMANN bone rongeur jaw 1,3mm, straight	14,0cm; 5,6"	
196-205-15	jaw 1,3mm, curved	14,0cm; 5,6"	
196-206-15	jaw 1,3mm, 90°	13,5cm; 5,4"	
196-211-13	UNIVERSAL bone rongeur	13,5cm; 5,4"	
196-217-17	BEYER bone rongeur; curved	17,5cm; 7"	
196-236-16	LEMPERT bone rongeur straight	16,0cm; 6,4"	
196-237-16	curved		
196-241-20	BACON bone rongeur	20,0cm; 8"	
196-260-19	DEFOURMENTEL bone rongeur	19,0cm; 7,6"	
196-307-03	BÖHLER bone rongeur curved	15,0cm; 6"	
196-307-04	curved		
196-311-02	KLEINERT-KUTZ bone rongeur 2x13mm	15,0cm; 6"	
196-311-03	3x18mm		
196-315-15	RUSKIN-MINI bone rongeur	15,0cm; 6"	
196-350-04	LEKSELL-STILLE bone rongeur jaw 4mm; double convertible; fully cvd.	24,0cm; 9,6"	
196-350-08	jaw 8mm; double convertible; fully cvd.		
196-359-08	SYPERT bone rongeur; laterally curved, jaw 8mm; 35,0cm		
196-361-02	ECHLIN bone rongeur; sideways curved; jaw 3x10mm	23,0cm; 9,2"	
196-364-23	RUSKIN bone rongeur	23,0cm; 9,2"	
196-366-03	SMITH-PETERSON bone rongeur 3mm	24,0cm; 9,6"	
196-366-04	4mm		
196-366-05	5mm		
196-367-03	3mm		
196-367-04	4mm		
196-367-05	5mm		
196-369-03	3mm		
196-369-04	4mm		
196-369-05	5mm		

Weitere Artikel
further items
más artículos

Art.Nr.	Beschreibung Description	Size	Spez.
Other items available but not illustrated			
196-493-10	COBB elevator; 10mm	27,0cm; 10,8"	
196-505-16	CLEVELAND-GARDNER bone cutting forcps		
196-507-20	MARKWALDER bone cutting forcps	20,0cm; 8"	
196-524-15	LITTAUER-LISTON bone cutting forcps		
196-529-12	bone cutting forceps	12,0cm; 4,8"	
196-604-18 196-605-18	RUSKIN bone cutting forceps straight, curved	8,0cm; 7,2"	
196-986-03	lead hand for adutls; thick model		
196-986-10	BRUECKMANN lead hand		

Alphabetisches Verzeichnis

A	
ADSON, Bohrerführungsinstrument	190.13
ADSON, Raspatorium	193.7
ADSON, Spiralbohrer	190.17
ALDERDYCE, Raspatorium	193.5
ALEXANDER, Flachmeißel	194.5
ALEXANDER, Osteotom	194.5
ALEXANDER, Raspatorium	193.7
ALEXANDER, Hohlmeißel	194.5
Amputationssäge, BIER	190.11
Amputationssäge, CHARRIÈRE	190.10, 190.12
Amputationssäge, LANGENBECK	190.12
Amputationssäge, SATTERLEE	190.13
Amputationsschild, PERCY	190.13
B	
Bajonettkürette, cervical	192.14, 192.16
Bajonettkürette, lumbar	192.17
BENNET, Knochenheber	190.30
BERGMANN, Gipsäge	190.2
BEYER, Hohlmeißelzange	196.7
BIER, Amputationssäge	190.11
BIER, Ersatzsägeblatt	190.11
BIRCHER-GANSKE, Knorpelfasszange	195.4
Bleihand	196.17
BLOUNT, Kniehaken	190.29, 195.16
BLUMENTHAL, Hohlmeißelzange	196.5
BÖHLER, Extensionsbügel	190.31
BÖHLER, Hohlmeißelzange	196.7
BÖHLER, Knochensplitterzange	196.14
Bohrapparat, Hand-, BUNNELL	190.21
Bohrapparat, Hand-, HUDSON	190.16
Bohrapparat, Hand-, MOORE	190.17
Bohrapparat, Hand-, RALK	190.21
Bohrapparat, Hand-, STILLE	190.15
Bohrdrahtspender, VICKERS	190.39
Bohrer, Flach-, CUSHING	190.17
Bohrer, Spiral-	190.15, 190.19
Bohrer, Spiral-, ADSON	190.17
Bohrer, Spiral-, BORCHARDT	190.18
Bohrerführungsinstrument, ADSON	190.13
Bohrhandgriff	190.22
BORCHARDT, Flachbohrer	190.18
BORCHARDT, Spiralbohrer	190.18
BRAND, Sehnenfasszange	195.13
BRUNS, scharfer Löffel	192.8, 192.9
Bügel, Extensions-, BÖHLER	190.31
Bügel, Extensions-, KIRSCHNER	190.32- 190.34
BUNNELL, Handbohrapparat	190.21
BUNNELL, Sehnenstripper	195.14, 195.15
C	
CARROLL, Sehnenfasszange	195.13
cervical, Bajonettkürette	192.14, 192.16
CHARRIÈRE, Amputationssäge	190.10, 190.12
CHARRIÈRE, Ersatzsägeblatt	190.10
CLEVELAND, Hohlmeißelzange	196.3
CLEVELAND, Knochensplitterzange	196.13
COBB, Hohlmeißel	194.21
COBB, Raspatorium	193.12
COLLIN, Hammer	191.4
COTTLE, Hammer	191.3
CUSHING, Flachbohrer	190.17
CUSHING, Raspatorium	193.7
D	
DAHMEN, Hohlmeißel	194.22
DAHMEN, Osteotom	194.22
DAUBENSPECK, scharfer Löffel	192.13
DEMEL, Drahtumführungsnadel	190.47
DINGMANN, Knorpelfasszange	195.4
Distractionsklammer, GERSTER	195.2
DOYEN, Hammer	191.3
DOYEN, Kugelfräser	190.20
DOYEN, Raspatorium	193.11
Draht, Stahl-	190.48
Drahtgef echt	190.34
Drahtkneifzange	190.44
Drahtspanner, LOUTE	190.47
Drahtumführungsnadel, DEMEL	190.47
Dreibackenspannfutter	190.22
E	
ECHLIN, Hohlmeißelzange	196.11
Elevator, HOEN	193.6
Elevator, LANGENBECK	193.14, 193.15
Elevator, QUERVAIN	193.15
Elevator, SEBILEAU	193.15
Elevator, WILLIGER	193.14
ENGEL, Gipsäge	190.2
ERRICO, Fräser	190.17
Ersatzbacken, Hammer	191.9
Ersatzsägeblatt, BIER	190.11
Ersatzsägeblatt, CHARRIÈRE	190.10
Ersatzsägeblatt, SATTERLEE	190.13
ESMARCH, Gipsmesser	190.2
Extensionsbügel, BÖHLER	190.31, 190.32
Extensionsbügel, KIRSCHNER	190.32- 190.35
Extensionsnagel, STEINMANN	190.35
F	
FARABEUF, Knochenhaltezange	195.8
FARABEUF, Raspatorium	193.9
Fasszange, Parallel-	190.43
Feile, Knochen-	193.16
Feile, Knochen-, MILLER-COLBURN	193.17, 193.18
FERGUSSON, Knochenhaltezange	195.6
FISCHER, Sehnenstripper	195.14
Flachbohrer, BORCHARDT	190.18
Flachbohrer, CUSHING	190.17
Flachmeißel	194.3

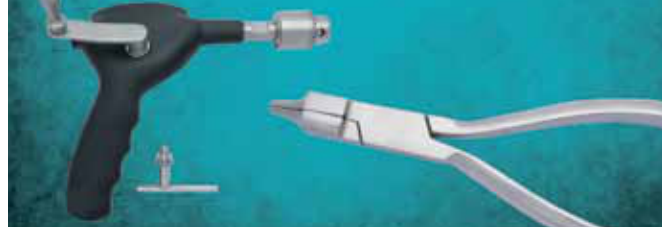

Alphabetisches Verzeichnis

Flachmeißel, ALEXANDER	194.5
Flachmeißel, HIBBS	194.7
Flachmeißel, PARTSCH	194.6
Flachmeißel, STILLE	194.15
Flachmeißelklinge	194.24
Flachzange	190.40- 190.42
Flachzange, HACKSTOCK	190.40
Fräser, ERRICO	190.17
Fräser, Kegel-, HUDSON	190.16
Fräser, Kugel-	190.19
Fräser, Kugel-, DOYEN	190.20
Fräser, MC KENZIE	190.17
Fräser, Oval-	190.19
FRIEDMANN, Hohlmeißelzange	196.2
FRYKHOLM, Hohlmeißelzange	196.11
Führungsinstrument, Bohrer-, ADSON	190.13

G

Gabelschlüssel, KIRSCHNER	190.33
Geflecht, Draht-	190.34
GERSTER, Distractionsklammer	195.2
GERSTER-LOWMAN, Knochenhalteklammer	195.2
Gipsabreißzange, WOLFF	190.3
Gipsmesser, ESMARCH	190.2
Gipsmesser, HOPKINS	190.2
Gipsmesser, REINER	190.2
Gipssäge, BERGMANN	190.2

Gipssäge, ENGEL	190.2
Gipsschere, STILLE	190.4
Gipsspreizer, HENNING	190.3
Gipsspreizer, MODELL USA	190.3
Griff, Meißel	194.23

H

HACKSTOCK, Flachzange	190.40
Haken, Knie-, BLOUNT	190.29, 195.16
Haken, Zug-, KIRSCHNER	190.33
HALLE, scharfer Löffel	192.6
Hammer	191.5- 191.8
Hammer, COTTLE	191.3
Hammer, DOYEN	191.3
Hammer, Ersatzbacken	191.9
Hammer, HERBERT	191.9
Hammer, LUCAE	191.5
Hammer, PARTSCH	191.2
Hammer, WILLIGER	191.2, 191.4
Hammer, COLLIN	191.4
Hand, Blei-	196.17
Handbohrapparat, BUNNELL	190.21
Handbohrapparat, HUDSON	190.16
Handbohrapparat, MOORE	190.17
Handbohrapparat, RALK	190.21
Handbohrapparat, STILLE	190.15
HARTMANN, Hohlmeißelzange	196.5
Hebel, Knochen-	190.25

Hebel, Knochen-, BENNETT	190.30
Hebel, Knochen-, HOHMANN	190.26- 190.28
Hebel, Knochen-, LANGE-HOHMANN	190.28
Hebel, Knochen-, MINI-HOHMANN	190.25
Hebel, Knochen-, TAYLOR	190.30
Hebel, Knochen-, VERBRUGGE-MÜLLER	190.25
HENNING, Gipsspreizer	190.3
HERBERT, Hammer	191.9
HIBBS, Flachmeißel	194.7
HIBBS, Hohlmeißel	194.10, 194.11
HIBBS, Osteotom	194.8, 194.9
HOEN, Elevator	193.6
Hohlmeißel	194.3
Hohlmeißel, ALEXANDER	194.5
Hohlmeißel, COBB	194.21
Hohlmeißel, DAHMEN	194.22
Hohlmeißel, HIBBS	194.10, 194.11
Hohlmeißel, LEXER	194.18- 194.20
Hohlmeißel, MINI-LEXER	194.17
Hohlmeißel, PARTSCH	194.6, 194.7
Hohlmeißel, SMITH-PETERSEN	194.14
Hohlmeißel, STILLE	194.16
Hohlmeißelklinge	194.24
Hohlmeißelzange	196.4
Hohlmeißelzange, BEYER	196.7
Hohlmeißelzange, BLUMENTHAL	196.5
Hohlmeißelzange, BÖHLER	196.7
Hohlmeißelzange, CLEVELAND	196.3
Hohlmeißelzange, ECHLIN	196.11
Hohlmeißelzange, FRIEDMANN	196.2
Hohlmeißelzange, FRYKHOLM	196.11
Hohlmeißelzange, HARTMANN	196.5
Hohlmeißelzange, JANSEN	196.3, 196.4
Hohlmeißelzange, LEKSELL-STILLE	196.10
Hohlmeißelzange, LEMPERS	196.6
Hohlmeißelzange, LUER	196.6
Hohlmeißelzange, MARQUARDT	196.6
Hohlmeißelzange, MAYFIELD	196.6
Hohlmeißelzange, MEAD	196.4
Hohlmeißelzange, RUSKIN	196.8, 196.9
Hohlmeißelzange, SAUERBRUCH	196.11
Hohlmeißelzange, SEMB	196.9
Hohlmeißelzange, STELLBRINK	196.2
Hohlmeißelzange, STILLE	196.9
Hohlmeißelzange, STILLE-LUER	196.10
Hohlmeißelzange, STILLE-RUSKIN	196.9
Hohlmeißelzange, ZAUFAL-JANSEN	196.7
HOHMANN, Knochenhebel	190.26- 190.28
HOKE, Osteotom	194.4
HOPKINS, Gipsmesser	190.2
HUDSON, Handbohrapparat	190.16
HUDSON, Kegelfräser	190.16
HUDSON, Verlängerungsstück	190.16

J

JANSEN, Hohlmeißelzange	196.3, 196.4
-------------------------------	--------------

Alphabetisches Verzeichnis

JANSEN, scharfer Löffel..... 192.2

K

KAZANJIAN, Knochensplitterzange..... 196.12
 Kegelfräser, HUDSON..... 190.16
 KERN, Knochenhalte-zange..... 195.6
 KEY, Raspatorium..... 193.2
 KIRSCHNER, Extensionsbügel..... 190.32- 190.34
 KIRSCHNER, Gabelschlüssel..... 190.33
 KIRSCHNER, Knochennagel..... 190.36- 190.38
 KIRSCHNER, Spannschlüssel..... 190.32
 KIRSCHNER, Zughaken..... 190.33
 Klammer, Distraktions-, GERSTER..... 195.2
 Klammer, Knochenhalte-, GERSTER-LOWMAN..... 195.2
 KLEINERT-KUTZ, Sehnenfazzzange..... 195.13
 Klemme, Sehneneinf echt-..... 195.12
 Klinge, Flachmeißel-..... 194.24
 Klinge, Hohlmeißel-..... 194.24
 Klinge, Osteotom-..... 194.23
 Kniehaken, BLOUNT..... 190.29, 195.16
 Knochenfeile..... 193.16
 Knochenfeile, MILLER-COLBURN..... 193.17, 193.18
 Knochenhalteklammer, GERSTER-LOWMAN..... 195.2
 Knochenhalte-zange..... 195.3, 195.10
 Knochenhalte-zange, FARABEUf..... 195.8
 Knochenhalte-zange, FERGUSSON..... 195.6
 Knochenhalte-zange, KERN..... 195.6
 Knochenhalte-zange, LAMBOTTE..... 195.9, 195.10
 Knochenhalte-zange, LANE..... 195.7
 Knochenhalte-zange, LANGENBECK..... 195.6
 Knochenhalte-zange, LEWIN..... 195.5
 Knochenhalte-zange, SEMB..... 195.7
 Knochenhalte-zange, ULRICH..... 195.11
 Knochenhalte-zange, VAN BUREN..... 195.3
 Knochenhalte-zange, VERBRUGGE..... 195.9
 Knochenhebel..... 190.25
 Knochenhebel, BENNET..... 190.30
 Knochenhebel, HOHMANN..... 190.26- 190.28
 Knochenhebel, LANGE-HOHMANN..... 190.28
 Knochenhebel, MINI-HOHMANN..... 190.25
 Knochenhebel, TAYLOR..... 190.30
 Knochenhebel, VERBRUGGE-MÜLLER..... 190.25
 Knochennagel, KIRSCHNER..... 190.36- 190.38
 Knochensplitterzange, BÖHLER..... 196.14
 Knochensplitterzange, CLEVELAND..... 196.13
 Knochensplitterzange, KAZANJIAN..... 196.12
 Knochensplitterzange, LISTON..... 196.12, 196.15
 Knochensplitterzange, LISTON-KEY..... 196.16
 Knochensplitterzange, LISTON-STILLE..... 196.15
 Knochensplitterzange, MC INDOE..... 196.14
 Knochensplitterzange, RUSKIN-LISTON..... 196.13, 196.14
 Knochensplitterzange, SEMB..... 196.16
 Knorpelfazzzange, BIRCHER-GANSKE..... 195.4
 Knorpelfazzzange, MARTIN..... 195.4
 Kombinationszange..... 190.41
 KÖNIG, Raspatorium..... 193.9

Kopfschneider..... 190.46
 Korpelfazzzange, DINGMANN..... 195.4
 Kugelfräser..... 190.15, 190.19
 Kugelfräser, DOYEN..... 190.20
 Kürette, bajonett, cervical..... 192.14, 192.16
 Kürette, bajonett, lumbar..... 192.17

L

LAMBOTTE, Knochenhalte-zange..... 195.9, 195.10
 LAMBOTTE, Osteotom..... 194.26, 194.27
 LAMBOTTE, Raspatorium..... 193.9
 LANE, Knochenhalte-zange..... 195.7
 LANGEBECK, Raspatorium..... 193.2
 LANGE-HOHMANN, Knochenhebel..... 190.28
 LANGENBECK, Amputationssäge..... 190.12
 LANGENBECK, Elevator..... 193.14, 193.15
 LANGENBECK, Knochenhalte-zange..... 195.6
 LANGENBECK, Raspatorium..... 193.8
 LEKSELL-STILLE, Hohlmeißelzange..... 196.10
 LEMPert, Hohlmeißelzange..... 196.6
 LEMPert, scharfer Löffel..... 192.6
 LEWIN, Knochenhalte-zange..... 195.5
 LEXER, Hohlmeißel..... 194.18- 194.20
 LEXER, Osteotom..... 194.17, 194.19
 LISTON, Knochensplitterzange..... 196.12, 196.15
 LISTON-KEY, Knochensplitterzange..... 196.16
 LISTON-STILLE, Knochensplitterzange..... 196.15
 Löffel, scharf-, BRUNS..... 192.8, 192.9
 Löffel, scharf-, DAUBENSPECK..... 192.13
 Löffel, scharf-, HALLE..... 192.6
 Löffel, scharf-, JANSEN..... 192.2
 Löffel, scharf-, LEMPert..... 192.6
 Löffel, scharf-, MODELL USA..... 192.4
 Löffel, scharf-, SCHEDE..... 192.7
 Löffel, scharf-, SIMON..... 192.6
 Löffel, scharf-, SPRATT..... 192.9
 Löffel, scharf-, SPRATT (BRUNS)..... 192.10
 Löffel, scharf-, STILLE..... 192.5
 Löffel, scharf-, UFFENORDE..... 192.7
 Löffel, scharf-, VOLKMANN..... 192.3, 192.8, 192.11
 Löffel, scharf-, WILLIGER..... 192.2
 LOUTE, Drahtspanner..... 190.47
 LUCAE, Hammer..... 191.5
 LUER, Hohlmeißelzange..... 196.5, 196.6
 lumbar, Bajonettkürette..... 192.17

M

MARQUARDT, Hohlmeißelzange..... 196.6
 MARTIN, Knorpelfazzzange..... 195.4
 MAYFIELD, Hohlmeißelzange..... 196.6
 MC INDOE, Knochensplitterzange..... 196.14
 MC KENZIE, Fräser..... 190.17
 MCDONALD, Raspatorium..... 193.6
 MEAD, Hohlmeißelzange..... 196.4
 Meißel, Flach-..... 194.3
 Meißel, Flach-, ALEXANDER..... 194.5



Alphabetisches Verzeichnis

Meißel, Flach-, HIBBS	194.7
Meißel, Flach-, PARTSCH	194.6
Meißel, Flach-, STILLE	194.15
Meißel, Hohl-	194.3
Meißel, Hohl-, ALEXANDER	194.5
Meißel, Hohl-, COBB	194.21
Meißel, Hohl-, DAHMEN	194.22
Meißel, Hohl-, HIBBS	194.10, 194.11
Meißel, Hohl-, LEXER	194.18- 194.20
Meißel, Hohl-, MINI-LEXER	194.17
Meißel, Hohl-, PARTSCH	194.6, 194.7
Meißel, Hohl-, SMITH-PETERSEN	194.14
Meißel, Hohl-, STILLE	194.16
Meißelgriff	194.23
Meniskussmesser	195.17
Meniskussmesser, SALENIUS	195.17
Meniskussmesser, SMILLIE	195.16
Meniskussmesser, NEFF	195.17
Messer, Gips-, ESMARCH	190.2
Messer, Gips-, HOPKINS	190.2
Messer, Gips-, REINER	190.2
Messer, Meniskus-	195.17
Messer, Meniskus-, NEFF	195.17
Messer, Meniskus-, SALENIUS	195.17
Messer, Meniskus-, SMILLIE	195.16
MILLER-COLBURN, Knochenfeile	193.17, 193.18
MINI-HOHMANN, Knochenhebel	190.25
MINI-LAMBOTTE, Osteotom	194.25
MINI-LEXER, Hohlmeißel	194.17
MINI-LEXER, Osteotom	194.16
MODELL USA, Gipsspreizer	190.3
MODELL USA, scharfer Löffel	192.4
MOORE, Handbohrapparat	190.17

N

Nadel, Drahtumführungs-, DEMEL	190.47
Nagel, Extensions-, STEINMANN	190.35
Nagel, Knochen-, KIRSCHNER	190.36- 190.38
NEFF, Meniskussmesser	195.17

O

Osteotom	194.3
Osteotom, ALEXANDER	194.5
Osteotom, DAHMEN	194.22
Osteotom, HIBBS	194.9
Osteotom, HOKE	194.4
Osteotom, LAMBOTTE	194.26, 194.27
Osteotom, LEXER	194.17, 194.19
Osteotom, MINI-LAMBOTTE	194.25
Osteotom, MINI-LEXER	194.16
Osteotom, SMITH-PETERSEN	194.12, 194.13
Osteotom, STILLE	194.15
Osteotomklinge	194.23
Ovalfräser	190.19

P

Parallelfasszange	190.43
PARTSCH, Flachmeißel	194.6
PARTSCH, Hammer	191.2
PARTSCH, Hohlmeißel	194.6, 194.7
PERCY, Amputationsschild	190.13
PERTHES, Reibahle	190.14

Q

QUERVAIN, Elevator	193.15
--------------------------	--------

R

RALK, Handbohrapparat	190.21
Raspatorium	193.3- 193.5, 193.13
Raspatorium ADSON	193.7
Raspatorium ALDERDYCE	193.5
Raspatorium LANGENBECK	193.2
Raspatorium MCDONALD	193.6
Raspatorium, ALEXANDER	193.7
Raspatorium, COBB	193.12
Raspatorium, CUSHING	193.7
Raspatorium, DOYEN	193.11
Raspatorium, FARABEUF	193.9
Raspatorium, KEY	193.2
Raspatorium, KÖNIG	193.9
Raspatorium, LAMBOTTE	193.9
Raspatorium, LANGENBECK	193.8
Raspatorium, SEDILLOT	193.10
Raspatorium, SEMB	193.8
Raspatorium, WAGNER	193.13
Reibahle	190.14
Reibahle, PERTHES	190.14
REINER, Gipsmesser	190.2
Repositionszange	195.2
Ring, Silikon-, Bleihand	196.17
RIPPENRASPATORIUM, DOYEN	193.11
RUSKIN, Hohlmeißelzange	196.8, 196.9
RUSKIN-LISTON, Knochensplitterzange	196.13, 196.14

S

Säge, Amputations-, BIER	190.11
Säge, Amputations-, CHARRIÈRE	190.10, 190.12
Säge, Amputations-, LANGENBECK	190.12
Säge, Amputations-, SATTERLEE	190.13
Säge, Gips-, BERGMANN	190.2
Säge, Gips-, ENGEL	190.2
Sägeblatt, Ersatz-, BIER	190.11
Sägeblatt, Ersatz-, CHARRIÈRE	190.10
Sägeblatt, Ersatz-, SATTERLEE	190.13
SALENIUS, Meniskussmesser	195.17
SATTERLEE, Amputationssäge	190.13
SATTERLEE, Ersatzsägeblatt	190.13
SAUERBRUCH, Hohlmeißelzange	196.11
Schädelspalter, VIRCHOW	194.2
scharfer Löffel, BRUNS	192.8, 192.9

Alphabetisches Verzeichnis

scharfer Löffel, DAUBENSPECK	192.13	STILLE, Handbohrapparat	190.15
scharfer Löffel, HALLE	192.6	STILLE, Hohlmeißel	194.16
scharfer Löffel, JANSEN	192.2	STILLE, Hohlmeißelzange	196.9
scharfer Löffel, LEMPERS	192.6	STILLE, Osteotom	194.15
scharfer Löffel, MODELL USA	192.4	STILLE, scharfer Löffel	192.5
scharfer Löffel, SCHEDE	192.7	STILLE-LUER, Hohlmeißelzange	196.10
scharfer Löffel, SIMON	192.6	STILLE-RUSKIN, Hohlmeißelzange	196.9
scharfer Löffel, SPRATT	192.9	Stößel	193.19
scharfer Löffel, SPRATT (BRUNS)	192.10	T	
scharfer Löffel, STILLE	192.5	TAYLOR, Knochenheber	190.30
scharfer Löffel, UFFENORDE	192.7	Tonnenzange	190.43
scharfer Löffel, VOLKMANN	192.3, 192.8, 192.11	U	
scharfer Löffel, WILLIGER	192.2	UFFENORDE, scharfer Löffel	192.7
SCHEDE, scharfer Löffel	192.7	ULRICH, Knochenhaltezange	195.11
Schere, Gips-, STILLE	190.4	V	
Schild, Amputations-, PERCY	190.13	VAN BUREN, Knochenhaltezange	195.3
Schraubendreher	190.23, 190.24	VERBRUGGE, Knochenhaltezange	195.9
SEBILEAU, Elevator	193.15	VERBRUGGE-MÜLLER, Knochenheber	190.25
SEDILLOT, Raspatorium	193.10	Verlängerungsstück, HUDSON	190.16
Sehndurchziehzange	195.12	VICKERS, Bohrdrahtspender	190.39
Sehneneinflecktlemme	195.12	VIRCHOW, Schädelspalter	194.2
Sehnenfasszange	195.14	VOLKMANN, scharfer Löffel	192.3, 192.8, 192.11
Sehnenfasszange, BRAND	195.13	W	
Sehnenfasszange, CARROLL	195.13	WAGNER, Raspatorium	193.13
Sehnenfasszange, KLEINERT-KUTZ	195.13	WILLIGER, Elevator	193.14
Sehnenfasszange, STEINMANN	195.13	WILLIGER, Hammer	191.2, 191.4
Sehnenstripper	195.15	WILLIGER, Raspatorium	193.10
Sehnenstripper, BUNNELL	195.14, 195.15	WILLIGER, scharfer Löffel	192.2
Sehnenstripper, FISCHER	195.14	WOLFF, Gipsabreißzange	190.3
Seitenschneider	190.45, 190.46	Z	
SEMB, Hohlmeißelzange	196.9	Zange, Drahtkneif-	190.44
SEMB, Knochensplitterzange	196.16	Zange, Flach-	190.40- 190.42
SEMB, Raspatorium	193.8	Zange, Flach-, HACKSTOCK	190.40
SEMB, Knochenhaltezange	195.7	Zange, Gipsabreiß-, WOLFF	190.3
Silikonring, Bleihand	196.17	Zange, Hohlmeißel-	196.4
SIMON, scharfer Löffel	192.6	Zange, Hohlmeißel-, BEYER	196.7
SMILLIE, Meniskusmesser	195.16	Zange, Hohlmeißel-, BLUMENTHAL	196.5
SMITH-PETERSEN, Hohlmeißel	194.14	Zange, Hohlmeißel-, BÖHLER	196.7
SMITH-PETERSEN, Osteotom	194.12, 194.13	Zange, Hohlmeißel-, CLEVELAND	196.3
Spanner, Draht-, LOUTE	190.47	Zange, Hohlmeißel-, ECHLIN	196.11
Spannschlüssel	190.22, 194.23	Zange, Hohlmeißel-, FRIEDMANN	196.2
Spannschlüssel, KIRSCHNER	190.32	Zange, Hohlmeißel-, FRYKHOLM	196.11
Spender, Bohrdraht-, VICKERS	190.39	Zange, Hohlmeißel-, HARTMANN	196.5
Spiralbohrer	190.15, 190.19	Zange, Hohlmeißel-, JANSEN	196.3
Spiralbohrer, ADSON	190.17	Zange, Hohlmeißel-, JANSEN	196.3, 196.4
Spiralbohrer, BORCHARDT	190.18	Zange, Hohlmeißel-, LEKSELL-STILLE	196.10
SPRATT (BRUNS), scharfer Löffel	192.10	Zange, Hohlmeißel-, LEMPERS	196.6
SPRATT, scharfer Löffel	192.9	Zange, Hohlmeißel-, LUER	196.5, 196.6
Spreizer, Gips-, HENNING	190.3	Zange, Hohlmeißel-, MARQUARDT	196.6
Spreizer, Gips-, MODELL USA	190.3	Zange, Hohlmeißel-, MAYFIELD	196.6
Stahldraht	190.48	Zange, Hohlmeißel-, MEAD	196.4
STEINMANN, Extensionsnagel	190.35		
STEINMANN, Sehnenfasszange	195.13		
STELLBRINK, Hohlmeißelzange	196.2		
STILLE Gipschere	190.4		
STILLE, Flachmeißel	194.15		

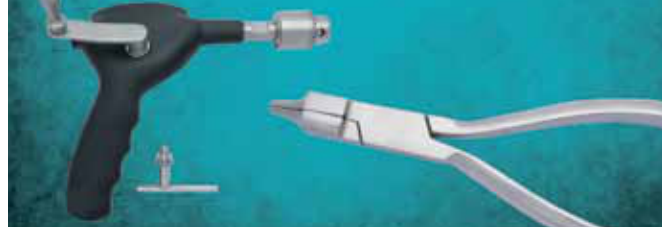

Alphabetisches Verzeichnis

Zange, Hohlmeißel-, RUSKIN.....	196.8, 196.9
Zange, Hohlmeißel-, SAUERBRUCH	196.11
Zange, Hohlmeißel-, SEMB	196.9
Zange, Hohlmeißel-, STELLBRINK.....	196.2
Zange, Hohlmeißel-, STILLE.....	196.9
Zange, Hohlmeißel-, STILLE-LUER.....	196.10
Zange, Hohlmeißel-, STILLE-RUSKIN.....	196.9
Zange, Hohlmeißel-, ZAUFAL-JANSEN	196.7
Zange, Knochenhalte-	195.3, 195.6, 195.10
Zange, Knochenhalte-, FARABEUFG.....	195.8
Zange, Knochenhalte-, FERGUSSON.....	195.6
Zange, Knochenhalte-, KERN	195.6
Zange, Knochenhalte-, LAMBOTTE.....	195.9, 195.10
Zange, Knochenhalte-, LANE.....	195.7
Zange, Knochenhalte-, LANGENBECK.....	195.6
Zange, Knochenhalte-, LEWIN.....	195.5
Zange, Knochenhalte-, SEMB	195.7
Zange, Knochenhalte-, ULRICH.....	195.11
Zange, Knochenhalte-, VAN BUREN.....	195.3
Zange, Knochenhalte-, VERBRUGGE.....	195.9
Zange, Knochensplitter-, CLEVELAND	196.13
Zange, Knochensplitter-, KAZANJIAN	196.12
Zange, Knochensplitter-, LISTON	196.12, 196.15
Zange, Knochensplitter-, LISTON-KEY	196.16
Zange, Knochensplitter-, LISTON-STILLE	196.15
Zange, Knochensplitter-, MC INDOE	196.14
Zange, Knochensplitter-, RUSKIN-LISTON.....	196.13, 196.14
Zange, Knochensplitter-, SEMB.....	196.16
Zange, Knorpelfass-, BIRCHER-GERSKE	195.4
Zange, Knorpelfass-, DINGMANN	195.4
Zange, Knorpelfass-, MARTIN	195.4
Zange, Kombinations-	190.41
Zange, Repositions-	195.2
Zange, Sehnendurchzieh-	195.12
Zange, Sehnenfass-	195.14
Zange, Sehnenfass-, BRAND.....	195.13
Zange, Sehnenfass-, CARROLL.....	195.13
Zange, Sehnenfass-, KLEINERT-KUTZ	195.13
Zange, Sehnenfass-, STEINMANN	195.13
Zange, Tonnen-	190.43
Zange, Knochensplitter-, BÖHLER.....	196.14
ZAUFAL-JANSEN, Hohlmeißelzange	196.7
Zughaken, KIRSCHNER.....	190.33

Index, alphabetical

A

ADSON, drill guide	190.13
ADSON, periosteal elevator.....	193.7
ADSON, twist drill.....	190.17
ALDERDYCE, periosteal elevator.....	193.5
ALEXANDER, chisel	194.5
ALEXANDER, gouge.....	194.5
ALEXANDER, osteotome.....	194.5
ALEXANDER, periosteal elevator.....	193.7
amputation retractor, PERCY	190.13
amputation saw, BIER.....	190.11
amputation saw, CHARRIÈRE.....	190.10, 190.12
amputation saw, LANGENBECK.....	190.12
amputation saw, SATTERLEE.....	190.13
bayonet curette, cervical.....	192.14, 192.16
bayonet curette, lumbar	192.17

B

BENNETT, bone lever	190.30
BERGMANN, plaster saw.....	190.2
BEYER, bone rongeur	196.7
BIER, amputation saw	190.11
BIER, saw blade	190.11
BIRCHER-GANSKE, cartilage seizing forceps	195.4
blade, chisel	194.24
blade, gouge	194.24
blade, osteotome	194.23
blade, saw, BIER	190.11
blade, saw, CHARRIÈRE.....	190.10
blade, saw, SATTERLEE.....	190.13
BLOUNT, knee retractor	190.29, 195.16

BLUMENTHAL, bone rongeur	196.5
BÖHLER, bone cutting forcps.....	196.14
BÖHLER, bone lever	190.31
BÖHLER, bone rongeur.....	196.7
bone curette, BRUNS.....	192.8, 192.9
bone curette, DAUBENSPECK.....	192.13
bone curette, HALLE.....	192.6
bone curette, JANSEN	192.2
bone curette, LEMPERT.....	192.6
bone curette, MODELL USA	192.4
bone curette, SCHEDE.....	192.7
bone curette, SIMON	192.6
bone curette, SPRATT	192.9
bone curette, SPRATT (BRUNS).....	192.10
bone curette, STILLE.....	192.5
bone curette, UFFENORDE.....	192.7
bone curette, VOLKMANN	192.3, 192.8, 192.11
bone curette, WILLIGER.....	192.2
bone cutting forceps, BÖHLER.....	196.14
bone cutting forceps, CLEVELAND.....	196.13
bone cutting forceps, KAZANJIAN.....	196.12
bone cutting forceps, LISTON.....	196.12, 196.15
bone cutting forceps, LISTON-KEY	196.16

bone cutting forceps, LISTON-STILLE.....	196.15
bone cutting forceps, RUSKIN-LISTON	196.13, 196.14
bone cutting forceps, SEMB	196.16
bone file.....	193.16
bone file, MILLER-COLBURN	193.17, 193.18
bone holding clamps, GERSTER-LOWMAN	195.2
bone holding forceps	195.3, 195.5, 195.6, 195.10
bone holding forceps, FARABEU.....	195.8
bone holding forceps, FERGUSSON	195.6
bone holding forceps, KERN.....	195.6
bone holding forceps, LAMBOTTE.....	195.9, 195.10
bone holding forceps, LANE	195.7
bone holding forceps, LANGENBECK	195.6
bone holding forceps, LEWIN	195.5
bone holding forceps, ULRICH	195.11
bone holding forceps, VAN BUREN	195.3
bone holding forceps, VERBRUGGE	195.9
bone holding forcps, SEMB	195.7
bone lever	190.25
bone lever, BENNETT.....	190.30
bone lever, BÖHLER.....	190.31
bone lever, HOHMANN	190.26- 190.28
bone lever, KIRSCHNER.....	190.32- 190.34
bone lever, LANGE-HOHMANN	190.28
bone lever, MINI-HOHMANN.....	190.25
bone lever, TAYLOR.....	190.30
bone lever, VERBRUGGE-MÜLLER	190.25
bone rongeur	196.4
bone rongeur, BEYER.....	196.7
bone rongeur, BLUMENTHAL	196.5
bone rongeur, BÖHLER.....	196.7
bone rongeur, CLEVELAND.....	196.3
bone rongeur, ECHLIN	196.11
bone rongeur, FRIEDMANN.....	196.2
bone rongeur, FRYKHOLM	196.11
bone rongeur, HARTMANN	196.5
bone rongeur, JANSEN	196.3, 196.4
bone rongeur, LEKSELL-STILLE	196.10
bone rongeur, LEMPERT	196.6
bone rongeur, LUER.....	196.5, 196.6
bone rongeur, MARQUARDT.....	196.6
bone rongeur, MAYFIELD	196.6
bone rongeur, MEAD	196.4
bone rongeur, RUSKIN	196.8, 196.9
bone rongeur, SAUERBRUCH.....	196.11
bone rongeur, SEMB	196.9
bone rongeur, STELLBRINK.....	196.2
bone rongeur, STILLE.....	196.9
bone rongeur, STILLE-LUER	196.10
bone rongeur, STILLE-RUSKIN	196.9
bone rongeur, ZAUFAL-JANSEN.....	196.7
bone wire.....	190.48
BORCHARDT, flat trephine.....	190.18
BORCHARDT, twist drill	190.18
BRAND, tendon holding forceps	195.13
breaker, plaster WOLFF.....	190.3



Index, alphabetical

breaker, skull, VIRCHOW.....	194.2
BRUNS, bone curette.....	192.8, 192.9
BUNNELL, hand drill.....	190.21
BUNNELL, tendon stripper.....	195.14, 195.15
burr, conical, HUDSON.....	190.16
burr, ERRICO.....	190.17
burr, MC KENZIE.....	190.17
burr, spherical.....	190.19
burr, spherical, DOYEN.....	190.20

C

CARROLL, tendon holding forceps.....	195.13
cartilage seizing forceps, BIRCHER-GANSKE.....	195.4
cartilage seizing forceps, DINGMANN.....	195.4
cartilage seizing forceps, MARTIN.....	195.4
cervical, bayonet curette.....	192.16
CHARRIÈRE, amputation saw.....	190.10, 190.12
CHARRIÈRE, saw blade.....	190.10
chisel.....	194.3
chisel blade.....	194.24
chisel handle.....	194.23
chisel, ALEXANDER.....	194.5
chisel, HIBBS.....	194.7
chisel, PARTSCH.....	194.6
chisel, STILLE.....	194.15
clamps, bone holding, GERSTER-LOWMAN.....	195.2
CLEVELAND, bone cutting forceps.....	196.13
CLEVELAND, bone rongeur.....	196.3
COBB, gouge.....	194.21
COBB, periosteal elevator.....	193.12
COLLIN, mallet.....	191.4
combi-flat nose plier.....	190.41
conical burr, HUDSON.....	190.16
COTTLE, mallet.....	191.3
curette, bayonet, cervical.....	192.14, 192.16
curette, bayonet, lumbar.....	192.17
curette, bone VOLKMANN.....	192.3
curette, bone, BRUNS.....	192.8, 192.9
curette, bone, DAUBENSPECK.....	192.13
curette, bone, HALLE.....	192.6
curette, bone, JANSEN.....	192.2
curette, bone, LEMPERT.....	192.6
curette, bone, MODELL USA.....	192.4
curette, bone, SCHEDE.....	192.7
curette, bone, SIMON.....	192.6
curette, bone, SPRATT.....	192.9
curette, bone, SPRATT (BRUNS).....	192.10
curette, bone, STILLE.....	192.5
curette, bone, UFFENORDE.....	192.7
curette, bone, VOLKMANN.....	192.8, 192.11
curette, bone, WILLIGER.....	192.2
CUSHING, flat trephine.....	190.17
CUSHING, periosteal elevator.....	193.7

D

DAHMEN, gouge.....	194.22
--------------------	--------

DAHMEN, osteotome.....	194.22
DAUBENSPECK, bone curette.....	192.13
DEMEL, wire guide.....	190.47
DINGMANN, cartilage seizing forceps.....	195.4
dispenser, K-wire, VICKERS.....	190.39
DOYEN, mallet.....	191.3
DOYEN, periosteal elevator.....	193.11
DOYEN, spherical burr.....	190.20
drill guide, ADSON.....	190.13
drill, hand, BUNNELL.....	190.21
drill, hand, HUDSON.....	190.16
drill, hand, MOORE.....	190.17
drill, hand, RALK.....	190.21
drill, hand, STILLE.....	190.15
drill, twist.....	190.15, 190.19
drill, twist, ADSON.....	190.17
drill, twist, BORCHARDT.....	190.18

E

ECHLIN, bone rongeur.....	196.11
elevator, LANGENBECK.....	193.14, 193.15
elevator, periosteal.....	193.3- 193.5, 193.13
elevator, periosteal, ADSON.....	193.7
elevator, periosteal, ALDERDYCE.....	193.5
elevator, periosteal, ALEXANDER.....	193.7
elevator, periosteal, COBB.....	193.12
elevator, periosteal, CUSHING.....	193.7
elevator, periosteal, DOYEN.....	193.11
elevator, periosteal, FARABEU.....	193.9
elevator, periosteal, HOEN.....	193.6
elevator, periosteal, KEY.....	193.2
elevator, periosteal, KÖNIG.....	193.9
elevator, periosteal, LAMBOTTE.....	193.9
elevator, periosteal, LANGENBECK.....	193.2, 193.8
elevator, periosteal, MCDONALD.....	193.6
elevator, periosteal, SEDILLOT.....	193.10
elevator, periosteal, SEMB.....	193.8
elevator, periosteal, WAGNER.....	193.13
elevator, periosteal, WILLIGER.....	193.10
elevator, QUERVAIN.....	193.15
elevator, SEBILEAU.....	193.15
elevator, WILLIGER.....	193.14
ENGEL, plaster saw.....	190.2
ERRICO, burr.....	190.17
ESMARCH, plaster knife.....	190.2
extension piece, HUDSON.....	190.16
extension pin, KIRSCHNER.....	190.36- 190.38
extension pin, STEINMANN.....	190.35

F

FARABEU, bone holding forceps.....	195.8
FARABEU, periosteal elevator.....	193.9
FERGUSSON, bone holding forceps.....	195.6
file, bone.....	193.16
file, bone, MILLER-COLBURN.....	193.17, 193.18
FISCHER, tendon stripper.....	195.14

Index, alphabetical

flat nose plier	190.40- 190.41
flat nose plier, HACKSTOCK	190.40
flat trephine, BORCHARDT	190.18
flat trephine, CUSHING	190.17
forceps, bone cutting, CLEVELAND	196.13
forceps, bone cutting, KAZANJIAN	196.12
forceps, bone cutting, LISTON	196.12, 195.15
forceps, bone cutting, LISTON-STILLE	196.15
forceps, bone cutting, MC INDOE	196.14
forceps, bone cutting, RUSKIN-LISTON	196.13, 196.14
forceps, bone cutting, SEMB	196.16
forceps, bone holding	195.3, 195.5, 195.6, 195.10
forceps, bone holding, FARABEUUF	195.8
forceps, bone holding, FERGUSSON	195.6
forceps, bone holding, KERN	195.6
forceps, bone holding, LANE	195.7
forceps, bone holding, LANGENBECK	195.6
forceps, bone holding, LEWIN	195.5
forceps, bone holding, SEMB	195.7
forceps, bone holding, ULRICH	195.11
forceps, bone holding, VAN BUREN	195.3
forceps, bone holding, VERBRUGGE	195.9
forceps, cartilage seizing, BIRCHER-GANSKE	195.4
forceps, cartilage seizing, DINGMANN	195.4
forceps, cartilage seizing, MARTIN	195.4
forceps, reposition	195.2
forceps, tendon holding	195.12, 195.14
forceps, tendon holding, BRAND	195.13
forceps, tendon holding, KLEINERT-KUTZ	195.13
forceps, tendon holding, STEINMANN	195.13
forceps, tendon interlacing	195.12
forceps, bone cutting, BÖHLER	196.14
forceps, bone cutting, LISTON-KEY	196.16
forceps, bone holding, LAMBOTTE	195.9, 195.10
forceps, tendon holding, CARROLL	195.13
FRIEDMANN, bone rongeur	196.2
FRYKHOLM, bone rongeur	196.11

G

GERSTER, traction bar	195.2
GERSTER-LOWMAN, bone holding clamps	195.2
gouge	194.3
gouge blade	194.24
gouge, ALEXANDER	194.5
gouge, COBB	194.21
gouge, DAHMEN	194.22
gouge, HIBBS	194.10, 194.11
gouge, LEXER	194.18- 194.20
gouge, MINI-LEXER	194.17
gouge, PARTSCH	194.6, 194.7
gouge, SMITH-PETERSEN	194.14
gouge, STILLE	194.16
guide, drill, ADSON	190.13
guide, wire, DEMEL	190.47

H

HACKSTOCK, flat nose plier	190.40
HALLE, bone curette	192.6
hand drill, BUNNELL	190.21
hand drill, HUDSON	190.16
hand drill, MOORE	190.17
hand drill, RALK	190.21
hand drill, STILLE	190.15
hand, lead	196.17
handle	190.22
handle, chisel	194.23
HARTMANN, bone rongeur	196.5
HENNING, plaster spreader	190.3
HERBERT, mallet	191.9
HIBBS, chisel	194.7
HIBBS, gouge	194.10, 194.11
HIBBS, osteotome	194.8, 194.9
HOEN, periosteal elevator	193.6
HOHMANN, bone lever	190.26- 190.28
HOKE, osteotome	194.4
hook, traction, KIRSCHNER	190.33
HOPKINS, plaster knife	190.2
HUDSON, conical burr	190.16
HUDSON, extension piece	190.16
HUDSON, hand drill	190.16

J

JANSEN, bone curette	192.2
JANSEN, bone rongeur	196.3, 196.4

K

KAZANJIAN, bone cutting forceps	196.12
KERN, bone holding forceps	195.6
KEY, periosteal elevator	193.2
KIRSCHNER, bone lever	190.32- 190.34
KIRSCHNER, extension pin	190.36- 190.38
KIRSCHNER, traction hook	190.33
KIRSCHNER, wire strainer	190.32
KIRSCHNER, wrench	190.33
KLEINERT-KUTZ, tendon holding forceps	195.13
knee retractor, BLOUNT	190.29, 195.16
knife, meniscus	195.17
knife, meniscus, NEFF	195.17
knife, meniscus, SALENIUS	195.17
knife, meniscus, SMILLIE	195.16
knife, plaster REINER	190.2
knife, plaster, ESMARCH	190.2
knife, plaster, HOPKINS	190.2
KÖNIG, periosteal elevator	193.9
K-wire dispenser, VICKERS	190.39

L

LAMBOTTE, bone holding forceps	195.9, 195.10
LAMBOTTE, osteotome	194.26, 194.27
LAMBOTTE, periosteal elevator	193.9
LANE, bone holding forceps	195.7
LANGE-HOHMANN, bone lever	190.28



Index, alphabetical

LANGENBECK, amputation saw.....	190.12
LANGENBECK, bone holding forceps	195.6
LANGENBECK, elevator.....	193.14, 193.15
LANGENBECK, periosteal elevator.....	193.2, 193.8
lead hand.....	196.17
LEKSELL-STILLE, bone rongeur.....	196.10
LEMPERT, bone curette	192.6
LEMPERT, bone rongeur	196.6
lever, bone	190.25
lever, bone, BENNETT.....	190.30
lever, bone, BÖHLER.....	190.31
lever, bone, HOHMANN	190.26- 190.28
lever, bone, KIRSCHNER.....	190.32- 190.34
lever, bone, LANGE-HOHMANN	190.28
lever, bone, MINI-HOHMANN.....	190.25
lever, bone, TAYLOR.....	190.30
lever, bone, VERBRUGGE-MÜLLER.....	190.25
LEWIN, bone holding forceps	195.5
LEXER, gouge	194.18- 194.20
LEXER, osteotome	194.17, 194.19
LISTON, bone cutting forceps.....	196.12, 196.15
LISTON-KEY, bone cutting forceps.....	196.16
LISTON-STILLE, bone cutting forceps.....	196.15
LOUTE, wire tightener	190.47
LUCAE, mallet	191.5
LUER, bone rongeur.....	196.5, 196.6
lumbar, bayonet curette.....	192.17

M

mallet.....	191.5- 191.8
mallet, COLLIN	191.4
mallet, COTTLE	191.3
mallet, DOYEN	191.3
mallet, HERBERT	191.9
mallet, LUCAE.....	191.5
mallet, PARTSCH	191.2
mallet, spare facing	191.9
mallet, WILLIGER.....	191.2, 191.4
MARQUARDT, bone rongeur.....	196.6
MARTIN, cartilage seizing forceps	195.4
MAYFIELD, bone rongeur.....	196.6
MC INDOE, bone cutting forceps.....	196.14
MC KENZIE, burr.....	190.17
MCDONALD, periosteal elevator.....	193.6
MEAD, bone rongeur.....	196.4
meniscus knife.....	195.17
meniscus knife, NEFF.....	195.17
meniscus knife, SALENIUS	195.17
meniscus knife, SMILLIE.....	195.16
mesh, wire	190.34
MILLER-COLBURN, bone file	193.17, 193.18
MINI-HOHMANN, bone lever	190.25
MINI-LAMBOTTE, osteotome	194.25
MINI-LEXER, gouge	194.17
MINI-LEXER, osteotome	194.16
MODELL USA, bone curette	192.4

MODELL USA, plaster spreader.....	190.3
MOORE, hand drill	190.17

N

NEFF, meniscus knife	195.17
----------------------------	--------

O

osteotome	194.3
osteotome blade	194.23
osteotome, ALEXANDER.....	194.5
osteotome, DAHMEN	194.22
osteotome, HIBBS.....	194.8, 194.9
osteotome, HOKE	194.4
osteotome, LAMBOTTE	194.26, 194.27
osteotome, LEXER	194.17, 194.19
osteotome, MINI-LAMBOTTE	194.25
osteotome, MINI-LEXER	194.16
osteotome, SMITH-PETERSEN.....	194.12, 194.13
osteotome, STILLE.....	194.15

P

parallel plier	190.43
PARTSCH, chisel.....	194.6
PARTSCH, gouge.....	194.6, 194.7
PARTSCH, mallet	191.2
PERCY, amputation retractor	190.13
periosteal elevator	193.3- 193.5, 193.13
periosteal elevator, ADERDYCE	193.5
periosteal elevator, ADSON	193.7
periosteal elevator, ALEXANDER.....	193.7
periosteal elevator, COBB	193.12
periosteal elevator, CUSHING.....	193.7
periosteal elevator, DOYEN	193.11
periosteal elevator, FARABEUF	193.9
periosteal elevator, HOEN	193.6
periosteal elevator, KEY	193.2
periosteal elevator, KÖNIG	193.9
periosteal elevator, LAMBOTTE	193.9
periosteal elevator, LANGENBECK	193.2, 193.8
periosteal elevator, MCDONALD.....	193.6
periosteal elevator, SEDILLOT.....	193.10
periosteal elevator, SEMB	193.8
periosteal elevator, WAGNER.....	193.13
periosteal elevator, WILLIGER.....	193.10
PERTHES, reamer	190.14
pin, extension, KIRSCHNER.....	190.36- 190.38
pin, extension, STEINMANN	190.35
plaster breaker, WOLFF.....	190.3
plaster knife, ESMARCH	190.2
plaster knife, HOPKINS	190.2
plaster knife, REINER	190.2
plaster saw, BERGMANN.....	190.2
plaster saw, ENGEL.....	190.2
plaster shears, STILLE	190.4
plaster spreader, HENNING.....	190.3

Index, alphabetical

plaster spreader, MODELL USA.....	190.3
plier, combi-flat nose.....	190.41
plier, flat nose.....	190.40- 190.42
plier, flat note, HACKSTOCK.....	190.40
plier, parallel.....	190.43
plier, wire cutting.....	190.44- 190.46

Q

QUERVAIN, elevator.....	193.15
-------------------------	--------

R

RALK, hand drill.....	190.21
reamer.....	190.14
reamer, PERTHES.....	190.14
REINER, plaster knife.....	190.2
reposition forceps.....	195.2
retractor, amputation, PERCY.....	190.13
retractor, knee, BLOUNT.....	190.29, 195.16
ring, silicon, lead hand.....	196.17
rongeur, bone.....	196.4
rongeur, bone, BEYER.....	196.7
rongeur, bone, BLUMENTHAL.....	196.5
rongeur, bone, BÖHLER.....	196.7
rongeur, bone, CLEVELAND.....	196.3
rongeur, bone, ECHLIN.....	196.11
rongeur, bone, FRIEDMANN.....	196.2
rongeur, bone, FRYKHOLM.....	196.11
rongeur, bone, HARTMANN.....	196.5
rongeur, bone, JANSEN.....	196.3, 196.4
rongeur, bone, LEKSELL-STILLE.....	196.10
rongeur, bone, LEMPERT.....	196.6
rongeur, bone, LUER.....	196.5, 196.6
rongeur, bone, MARQUARDT.....	196.6
rongeur, bone, MAYFIELD.....	196.6
rongeur, bone, MEAD.....	196.4
rongeur, bone, RUSKIN.....	196.8, 196.9
rongeur, bone, SAUERBRUCH.....	196.11
rongeur, bone, SEMB.....	196.9
rongeur, bone, STELLBRINK.....	196.2
rongeur, bone, STILLE.....	196.9
rongeur, bone, STILLE-LUER.....	196.10
rongeur, bone, STILLE-RUSKIN.....	196.9
rongeur, bone, ZAUFAL-JANSEN.....	196.7
RUSKIN, bone rongeur.....	196.8, 196.8
RUSKIN-LISTON, bone cutting forceps.....	196.13, 196.14

S

SALENIUS meniscus knife.....	195.17
SATTERLEE, amputation saw.....	190.13
SATTERLEE, saw blade.....	190.13
SAUERBRUCH, bone rongeur.....	196.11
saw blade, BIER.....	190.11
saw blade, CHARRIÈRE.....	190.10
saw, amputation, BIER.....	190.11
saw, amputation, CHARRIÈRE.....	190.10, 190.12

saw, amputation, LANGENBECK.....	190.12
saw, amputation, SATTERLEE.....	190.13
saw, plaster, BERGMANN.....	190.2

saw, plaster, ENGEL.....	190.2
SCHEDE, bone curette.....	192.7
screwdriver.....	190.23, 190.24
SEBILEAU, elevator.....	193.15
SEDILLOT, periosteal elevator.....	193.10
SEMB, bone cutting forceps.....	196.16
SEMB, bone holding forceps.....	195.7
SEMB, bone rongeur.....	196.9
SEMB, periosteal elevator.....	193.8
shears, plaster, STILLE.....	190.4
silicon ring, lead hand.....	196.17
SIMON, bone curette.....	192.6
skull breaker, VIRCHOW.....	194.2
SMILLIE, meniscus knife.....	195.16
SMITH-PETERSEN, gouge.....	194.14
SMITH-PETERSEN, osteotome.....	194.12, 194.13
spare facing, mallet.....	191.9
spherical burr.....	190.15, 190.19
spherical burr, DOYEN.....	190.20
SPRATT (BRUNS), bone curette.....	192.10
SPRATT, bone curette.....	192.9
spreader, plaster, HENNING.....	190.3
spreader, plaster, MODELL USA.....	190.3
STEINMANN, extension pin.....	190.35
STEINMANN, tendon holding forceps.....	195.13
STELLBRINK, bone rongeur.....	196.2
STILLE, bone curette.....	192.5
STILLE, bone rongeur.....	196.9
STILLE, chisel.....	194.15
STILLE, gouge.....	194.16
STILLE, hand drill.....	190.15
STILLE, osteotome.....	194.15
STILLE, plaster shears.....	190.4
STILLE-LUER, bone rongeur.....	196.10
STILLE-RUSKIN, bone rongeur.....	196.9
stripper, tendon, BUNNELL.....	195.14, 195.15
stripper, tendon, FISCHER.....	195.14

T

tamper.....	193.19
TAYLOR, bone lever.....	190.30
tendon holding forceps.....	195.12, 195.14
tendon holding forceps, BRAND.....	195.13
tendon holding forceps, CARROLL.....	195.13
tendon holding forceps, KLEINERT-KUTZ.....	195.13
tendon holding forceps, STEINMANN.....	195.13
tendon interlacing forceps.....	195.12
tendon stripper.....	195.15
tendon stripper, BUNNELL.....	195.14, 195.15
tendon stripper, FISCHER.....	195.14
three-jaw chuck.....	190.22
traction bar, GERSTER.....	195.2

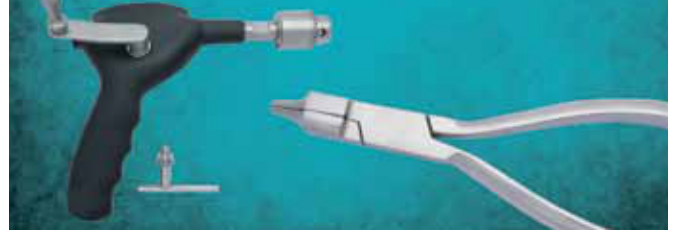

Index, alphabetical

traction hook, KIRSCHNER.....	190.33
trepphine, flat, BORCHARDT	190.18
trepphine, flat, CUSHING	190.17
twist drill	190.15, 190.19
twist drill, ADSON.....	190.17
twist drill, BORCHARDT.....	190.18

U

UFFENORDE, bone curette.....	192.7
ULRICH, bone holding forceps	195.11

V

VAN BUREN, bone holding forceps	195.3
VERBRUGGE, bone holding forceps	195.9
VERBRUGGE-MÜLLER, bone lever.....	190.25
VICKERS, K-wire dispenser	190.39
VIRCHOW, skull breaker.....	194.2
vise grip	190.43
VOLKMANN, bone curette	192.3, 192.8, 192.11

W

WAGNER, periosteal elevator	193.13
WILLIGER, bone curette.....	192.2
WILLIGER, elevator	193.14
WILLIGER, mallet	191.2, 191.4
WILLIGER, periosteal elevator	193.10
wire cutter front action	190.46
wire cutting plier.....	190.44- 190.46
wire guide, DEMEL	190.47
wire mesh	190.34
wire strainer, KIRSCHNER.....	190.32
wire tightener, LOUTE	190.47
wire, bone.....	190.48
WOLFF, plaster breaker.....	190.3
wrench, KIRSCHNER	190.33

Z

ZAUFAL-JANSEN, bone rongeur	196.7
-----------------------------------	-------

Índice, alfabético

A	
ADSON, broca espiral	190.17
ADSON, periostómos	193.7
ADSON, pinza-guia	190.13
alambre para hueso	190.48
ALDERDYCE, periostómos	193.5
ALEXANDER, cinceles	194.5
ALEXANDER, gubias	194.5
ALEXANDER, osteótomos	194.5
ALEXANDER, periostómos	193.7
alicantes de pico plano	190.40- 193.43
alicantes de pico plano, HACKSTOCK	190.40
alicantes para cortar alambre	190.44- 190.46
arandela, para manoplanos de plomo	196.17
B	
barra de tracción, GERSTER	195.2
BENNETT, elevadore para hueso	190.30
BERGMANN, sierra para yeso	190.2
BEYER, pinzas gubias	196.7
BIER, hoja de sierra	190.11
BIER, sierra de amputación	190.11
BIRCHER-GANSKE, pinzas para cartilago	195.4
BLOUNT, separadore para rodilla	190.29, 195.16
BLUMENTHAL, pinzas gubias	196.5
BÖHLER, elevadore para hueso	190.31
BÖHLER, pinzas cortantes para hueso	196.14
BÖHLER, pinzas gubias	196.7
BORCHARDT, broca espiral	190.18
BORCHARDT, taladro plano	190.18
BRAND, pinzas para coger tendones	195.13
broca espiral	190.15, 190.19
broca espiral, ADSON	190.17
broca espiral, BORCHARDT	190.18
BRUNS, cucharillas cortantes	192.8, 192.9
BUNNELL, enucleadores de tendons	195.14, 195.15
BUNNELL, perforatore a mano	190.21
burin pour le crâne, VIRCHOW	194.2
C	
CARROLL, pinzas para coger tendones	195.13
cervical, cucharillas bayoneta	192.14, 192.16
CHARRIÈRE, hoja de sierra	190.10
CHARRIÈRE, sierra de amputación	190.10, 190.12
cinceles	194.3
cinceles hoja	194.24
cinceles, ALEXANDER	194.5
cinceles, HIBBS	194.7
cinceles, PARTSCH	194.6
cinceles, STILLE	194.15
clavo de extensión, KIRSCHNER	190.36- 190.38
clavo de extensión, STEINMANN	190.35
CLEVELAND, pinzas cortantes para hueso	196.13
CLEVELAND, pinzas gubias	196.3
COBB, gubias	194.21
COBB, periostómos	193.12
COLLIN, martillos	191.4
combi-alicantes de pico plano	190.41
COTTLE, martillos	191.3
cucharillas bayoneta, cervical	192.14, 192.16
cucharillas bayoneta, lumbar	192.17
cucharillas cortantes, BRUNS	192.8, 192.9
cucharillas cortantes, DAUBENSPECK	192.13
cucharillas cortantes, HALLE	192.6
cucharillas cortantes, JANSEN	192.2
cucharillas cortantes, LEMPERS	192.6
cucharillas cortantes, MODELL USA	192.4
cucharillas cortantes, SCHEDE	192.7
cucharillas cortantes, SIMON	192.6
cucharillas cortantes, SPRATT	192.9
cucharillas cortantes, SPRATT (BRUNS)	192.10
cucharillas cortantes, STILLE	192.5
cucharillas cortantes, UFFENORDE	192.7
cucharillas cortantes, VOLKMANN	192.3, 192.8, 192.11
cucharillas cortantes, WILLIGER	192.2
cuchillo para yeso, ESMARCH	190.2
cuchillo para yeso, HOPKINS	190.2
cuchillo para yeso, REINER	190.2
cuchillos para menisco	195.17
cuchillos para menisco, NEFF	195.17
cuchillos para menisco, SALENIUS	195.17
cuchillos para menisco, SMILLIE	195.16
CUSHING, periostómos	193.7
CUSHING, taladro plano	190.17
D	
DAHMEN, gubias	194.22
DAHMEN, osteótomos	194.22
DAUBENSPECK, cucharillas cortantes	192.13
DEMEL, wire guide	190.47
destornilladores	190.23, 190.24
DINGMANN, pinzas para cartilago	195.4
dispensador para brocas filiformes, VICKERS	190.39
DOYEN, fresa esférica	190.20
DOYEN, martillos	191.3
DOYEN, periostómos	193.11
E	
ECHLIN, pinzas gubias	196.11
elevadore para hueso	190.25
elevadore para hueso, BENNETT	190.30
elevadore para hueso, BÖHLER	190.31
elevadore para hueso, HOHMANN	190.26, 190.27
elevadore para hueso, KIRSCHNER	190.32, 190.34
elevadore para hueso, LANGE-HOHMANN	190.28
elevadore para hueso, MINI-HOHMANN	190.25
elevadore para hueso, TAYLOR	190.30
elevadore para hueso, VERBRUGGE-MÜLLER	190.25
elevadores, LANGENBECK	193.14, 193.15
elevadores, QUERVAIN	193.15
elevadores, SEBILEAU	193.15

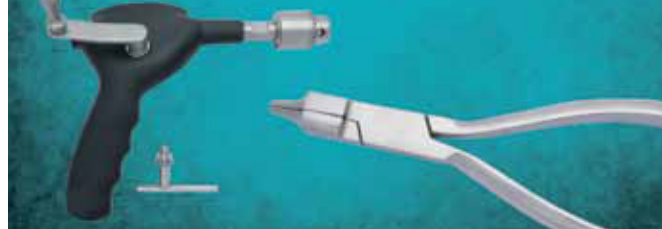

Indice, alfabético

elevadores, WILLIGER.....	193.14
ENGEL, sierra para yeso	190.2
enucleadores de tendons.....	195.15
enucleadores de tendons, BUNNELL	195.14, 195.15
enucleadores de tendons, FISCHER.....	195.14
ERRICO, taladros	190.17
escariadores	190.14
escariadores, PERTHES.....	190.14
ESMARCH, cuchillo para yeso.....	190.2

F

FARABEUF, periostómos.....	193.9
FARABEUF, pinzas para hueso	195.8
FERGUSSON, pinzas para hueso	195.6
FISCHER, enucleadores de tendons.....	195.14
forceps, bone holding	195.6
fresa esférica	190.15, 190.19
fresa esférica, DOYEN.....	190.20
fresa sferica, HUDSON.....	190.16
FRIEDMANN, pinzas gubias.....	196.2
FRYKHOLM, pinzas gubias.....	196.11

G

gancho de tracción para estribos, KIRSCHNER.....	190.33
GERSTER, barra de tracción.....	195.2
GERSTER-LOWMAN, grapas porta-huesos	195.2
grapasp porta-huesos, GERSTER-LOWMAN	195.2
gubias.....	194.3
gubias hoja	194.24
gubias, ALEXANDER.....	194.5
gubias, COBB.....	194.21
gubias, DAHMEN	194.22
gubias, HIBBS	194.10, 194.11
gubias, LEXER.....	194.18- 194.20
gubias, MINI-LEXER.....	194.17
gubias, PARTSCH	194.6, 194.7
gubias, SMITH-PETERSEN	194.14
gubias, STILLE	194.16

H

HACKSTOCK, alicantes de pico plano	190.40
HALLE, cucharillas cortantes	192.6
HARTMANN, pinzas gubias	196.5
HENNING, separador para yeso	190.3
HERBERT, martillos	191.9
HIBBS, cinceles.....	194.7
HIBBS, gubias	194.10, 194.11
HIBBS, osteótomos.....	194.8, 194.9
HOEN, periostómos	193.6
HOHMANN, elevadore para hueso	190.26- 190.28

hoja de sierra, BIER.....	190.11
hoja de sierra, CHARRIÈRE.....	190.10
hoja, cinceles.....	194.24
hoja, gubias.....	194.24
hoja, osteótomos.....	194.23

HOKE, osteótomos	194.4
HOPKINS, cuchillo para yeso.....	190.2
HUDSON, fresa sferica.....	190.16
HUDSON, perforatore a mano	190.16
HUDSON, pieza de prolongación.....	190.16

J

JANSEN, cucharillas cortantes	192.2
JANSEN, pinzas gubias.....	196.3, 196.4

K

KAZANJIAN, pinzas cortantes para hueso	196.12
KERN, pinzas para hueso.....	195.6
KEY, periostómos	193.2
KIRSCHNER, clavo de extensión.....	190.36- 190.38
KIRSCHNER, elevadore para hueso	190.32, 190.34
KIRSCHNER, gancho de tracción para estribos	190.33
KIRSCHNER, llave de tuercas.....	190.33
KIRSCHNER, tensor de taladros filiformes	190.32
KLEINERT-KUTZ, pinzas para coger tendones.....	195.13
KÖNIG, periostómos	193.9

L

LAMBOTTE, osteótomos	194.26, 194.27
LAMBOTTE, periostómos	193.9
LAMBOTTE, pinzas para hueso	195.9, 195.10
LANE, pinzas para hueso	195.7
LANGE-HOHMANN, elevadore para hueso	190.28
LANGENBECK, elevadores	193.14, 193.15
LANGENBECK, periostómos	193.2, 193.8
LANGENBECK, pinzas para hueso	195.6
LANGENBECK, sierra de amputación.....	190.12
LEKSELL-STILLE, pinzas gubias	196.10
LEMPERT, cucharillas cortantes	192.6
LEMPERT, pinzas gubias.....	196.6
LEWIN, pinzas para hueso	195.5
LEXER, gubias	194.18- 194.20
LEXER, osteótomos	194.17
limas para huesos	193.16
limas para huesos, MILLER-COLBURN.....	193.17, 193.18
LISTON, pinzas cortantes para hueso	196.12, 196.15
LISTON-KEY, pinzas cortantes para hueso.....	196.16
LISTON-STILLE, pinzas cortantes para hueso	196.15
llave de tuercas, KIRSCHNER.....	190.33
LOUTE, wire tightener	190.47
LUCAE, martillos	191.5
LUER, pinzas gubias	196.5, 196.6
lumbar, cucharillas bayoneta.....	192.17

M

malla de alambre	190.34
mandril de tres mordazas.....	190.22
mango para hojas de cincel	194.23
manoplanos de plomo	196.17
MARQUARDT, pinzas gubias	196.6
martillos	191.5- 191.8

Indice, alfabético

martillos, COLLIN	191.4
martillos, COTTLE	191.3
martillos, DOYEN	191.3
martillos, HERBERT	191.9
martillos, LUCAE	191.5
martillos, PARTSCH	191.2
martillos, tapas de repuesto de plástico	191.9
martillos, WILLIGER	191.2, 191.4
MARTIN, pinzas para cartilago	195.4
MAYFIELD, pinzas gubias	196.6
MC INDOE, pinzas cortantes para hueso	196.14
MC KENZIE, taladros	190.17
MCDONALD, periostómos	193.6
MEAD, pinzas gubias	196.4
MILLER-COLBURN, limas para huesos	193.17, 193.18
MINI-HOHMANN, elevadore para hueso	190.25
MINI-LAMBOTTE, osteótomos	194.25
MINI-LEXER, gubias	194.17
MINI-LEXER, osteótomos	194.16
MODELL USA, cucharillas cortantes	192.4
MODELL USA, separador para yeso	190.3
MOORE, perforatore a mano	190.17

N

NEFF, cuchillos para menisco	195.17
------------------------------------	--------

O

osteótomos	194.3
osteótomos hoja	194.23
osteótomos, ALEXANDER	194.5
osteótomos, DAHMEN	194.22
osteótomos, HIBBS	194.8, 194.9
osteótomos, HOKE	194.4
osteótomos, LAMBOTTE	194.26, 194.27
osteótomos, LEXER	194.17, 194.19
osteótomos, MINI-LAMBOTTE	194.25
osteótomos, MINI-LEXER	194.16
osteótomos, SMITH-PETERSEN	194.12, 194.13
osteótomos, STILLE	194.15

P

PARTSCH, cinceles	194.6
PARTSCH, gubias	194.6, 194.7
PARTSCH, martillos	191.2
PERCY, retractor para amputación	190.13
perforatore a mano, BUNNELL	190.21
perforatore a mano, HUDSON	190.16
perforatore a mano, MOORE	190.17
perforatore a mano, RALK	190.21
perforatore a mano, STILLE	190.15
periostómos	193.3- 193.5, 193.13
periostómos, ADERDYCE	193.5
periostómos, ADSON	193.7
periostómos, ALEXANDER	193.7
periostómos, COBB	193.12
periostómos, CUSHING	193.7

periostómos, DOYEN	193.11
periostómos, FARABEUF	193.9
periostómos, HOEN	193.6
periostómos, KEY	193.2
periostómos, KÖNIG	193.9
periostómos, LAMBOTTE	193.9
periostómos, LANGENBECK	193.2, 193.8
periostómos, MCDONALD	193.6
periostómos, SEDILLOT	193.10
periostómos, SEMB	193.8
periostómos, WAGNER	193.13
periostómos, WILLIGER	193.10
PERTHES, escariadores	190.14
pieza de prolongación, HUDSON	190.16
pinza para romper yeso, WOLFF	190.3
pinza-guia, ADSON	190.13
pinzas cortantes para hueso, BÖHLER	196.14
pinzas cortantes para hueso, CLEVELAND	196.13
pinzas cortantes para hueso, KAZANJIAN	196.12
pinzas cortantes para hueso, LISTON	196.12, 196.15
pinzas cortantes para hueso, LISTON-KEY	196.16
pinzas cortantes para hueso, LISTON-STILLE	196.15
pinzas cortantes para hueso, MC INDOE	196.14
pinzas cortantes para hueso, RUSKIN-LISTON	196.13, 196.14
pinzas cortantes para hueso, SEMB	196.16
pinzas gubias, BEYER	196.7
pinzas gubias, BLUMENTHAL	196.5
pinzas gubias, BÖHLER	196.7
pinzas gubias, CLEVELAND	196.3
pinzas gubias, ECHLIN	196.11
pinzas gubias, FRIEDMANN	196.2
pinzas gubias, FRYKHOLM	196.11
pinzas gubias, HARTMANN	196.5
pinzas gubias, JANSEN	196.3, 196.4
pinzas gubias, LEKSELL-STILLE	196.10
pinzas gubias, LEMPERS	196.6
pinzas gubias, LUER	196.6
pinzas gubias, MARQUARDT	196.6
pinzas gubias, MAYFIELD	196.6
pinzas gubias, MEAD	196.4
pinzas gubias, RUSKIN	196.8, 196.9
pinzas gubias, SAUERBRUCH	196.11
pinzas gubias, SEMB	196.9
pinzas gubias, STELLBRINK	196.2
pinzas gubias, STILLE	196.9
pinzas gubias, STILLE-LUER	196.10
pinzas gubias, STILLE-RUSKIN	196.9
pinzas gubias, ZAUFAL-JANSEN	196.7
pinzas para cartilago, BIRCHER-GANSKE	195.4
pinzas para cartilago, DINGMANN	195.4
pinzas para cartilago, MARTIN	195.4
pinzas para coger tendones	195.12, 195.14
pinzas para coger tendones, BRAND	195.13
pinzas para coger tendones, CARROLL	195.13
pinzas para coger tendones, KLEINERT-KUTZ	195.13
pinzas para coger tendones, STEINMANN	195.13



Indice, alfabético

pinzas para hueso, FARABEUF.....	195.8
pinzas para hueso, FERGUSSON.....	195.6
pinzas para hueso, KERN.....	195.6
pinzas para hueso, LAMBOTTE.....	195.9, 195.10
pinzas para hueso, LANE.....	195.7
pinzas para hueso, LANGENBECK.....	195.6
pinzas para hueso, LEWIN.....	195.5
pinzas para hueso, SEMB.....	195.7
pinzas para hueso, ULRICH.....	195.11
pinzas para hueso, VAN BUREN.....	195.3
pinzas para hueso, VERBRUGGE.....	195.9
pinzas para reposición.....	195.2
punzones metálicos.....	193.19

Q

QUERVAIN, elevadores.....	193.15
---------------------------	--------

R

RALK, perforatore a mano.....	190.21
REINER, cuchillo para yeso.....	190.2
retractor para amputación, PERCY.....	190.13
RUSKIN, pinzas gubias.....	196.8, 196.9
RUSKIN-LISTON, pinzas cortantes para hueso.....	196.13, 196.14

S

SALENIUS cuchillos para menisco.....	195.17
SATTERLEE, amputaion saw.....	190.13
SATTERLEE, hoja de sierra.....	190.13
SAUERBRUCH, pinzas gubias.....	196.11
SCHEDE, cucharillas cortantes.....	192.7
SEBILEAU, elevadores.....	193.15
SEDILLOT, periostómos.....	193.10
SEMB, periostómos.....	193.8
SEMB, pinzas cortantes para hueso.....	196.16
SEMB, pinzas gubias.....	196.9
SEMB, pinzas para hueso.....	195.7
separador para yeso, HENNING.....	190.3
separador para yeso, MODELL USA.....	190.3
separadore para rodilla, BLOUNT.....	190.29, 195.16
sierra de amputación, BIER.....	190.11
sierra de amputación, CHARRIÈRE.....	190.10, 190.12
sierra de amputación, LANGENBECK.....	190.12
sierra de amputación, SATTERLEE.....	190.13
sierra para yeso, BERGMANN.....	190.2

sierra para yeso, ENGEL.....	190.2
SIMON, cucharillas cortantes.....	192.6
SMILLIE, cuchillos para menisco.....	195.16
SMITH-PETERSEN, gubias.....	194.14
SMITH-PETERSEN, osteótomos.....	194.12, 192.13
SPRATT (BRUNS), cucharillas cortantes.....	192.10
SPRATT, cucharillas cortantes.....	192.9
STEINMANN, clavo de extensión.....	190.35
STEINMANN, pinzas para coger tendones.....	195.13
STELLBRINK, pinzas gubias.....	196.2
STILLE, cinceles.....	194.15

STILLE, cucharillas cortantes.....	192.5
STILLE, gubias.....	194.16
STILLE, osteótomos.....	194.15
STILLE, perforatore a mano.....	190.15
STILLE, pinzas gubias.....	196.9
STILLE, tijera para yeso.....	190.4
STILLE-LUER, pinzas gubias.....	196.10
STILLE-RUSKIN, pinzas gubias.....	196.9

T

taladro plano, BORCHARDT.....	190.18
taladro plano, CUSHING.....	190.17
taladros, ERRICO.....	190.17
taladros, MC KENZIE.....	190.17
tapas de repuesto de plástico , martillos.....	191.9
TAYLOR, elevadore para hueso.....	190.30
tendon interlacing forceps.....	195.12
tensor de taladros filiformes, KIRSCHNER.....	190.32
tijera para yeso, STILLE.....	190.4

U

UFFENORDE, cucharillas cortantes.....	192.7
ULRICH, pinzas para hueso.....	195.11

V

VAN BUREN, pinzas para hueso.....	195.3
VERBRUGGE, pinzas para hueso.....	195.9
VERBRUGGE-MÜLLER, elevadore para hueso.....	190.25
VICKERS, dispensador para brocas filiformes.....	190.39
VIRCHOW, burin pour le crâne.....	194.2
VOLKMANN, cucharillas cortantes.....	192.3, 192.8, 192.11

W

WAGNER, periostómos.....	193.13
WILLIGER, cucharillas cortantes.....	192.2
WILLIGER, elevadores.....	193.14
WILLIGER, martillos.....	191.2, 191.4
WILLIGER, periostómos.....	193.10
wire guide, DEMEL.....	190.47
wire tightener, LOUTE.....	190.47
WOLFF, pinza para romper yeso.....	190.3

Z

ZAUFAL-JANSEN, pinzas gubias.....	196.7
-----------------------------------	-------