

lamina spreaders

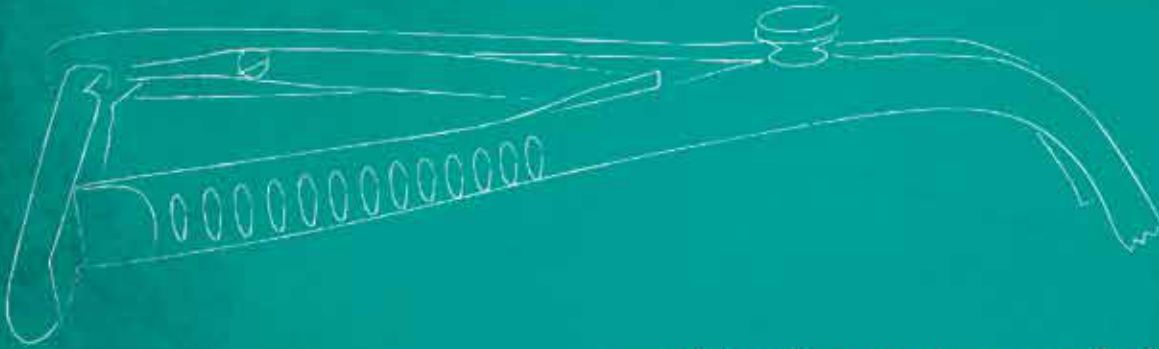

applying forceps for vessel clips



laminectomy punches



Neurochirurgie
Neurosurgery

243

Drahtsägen
Wire Saws
Sierras de hilo



Art.Nr.	Beschreibung Description	Size	Spez.
243-005-00	GIGLI Drahtsägen-Handgriff wire saws handle mango de gancho		



GIGLI (OLIVECRONA)

243-010-30	30,0cm; 11 6/8"
243-010-40	40,0cm; 15 6/8"
243-010-50	50,0cm; 19 5/8"
243-010-60	60,0cm; 23 5/8"
243-010-70	70,0cm; 27 4/8"



243-026-33	DE MARTEL Einführungsinstrument wire saw guide conductor para para sierras de hilo	33,0cm; 13"
------------	---	-------------



243

Schädelstanzen
 Cranial Rongeur
 Pinza sacabocados craneales

Art.Nr.	Beschreibung Description	Size	Spez.
243-040-00	DE VILBISS	21,0cm; 8 2/8"	



DE VILBISS Ersatzklingen
 spare blades only
 hoja de repuesto

243-040-01 Fig. 4



243-040-02 Fig. 5



Schädelstanzen
 Cranial Rongeur
 Pinza sacabocados craneales



Art.Nr.	Beschreibung Description	Size	Spez.
243-044-20	DAHLGREEN	19,5cm; 7 5/8"	



243-044-01	DAHLGREEN Ersatzklinge spare blade hoja de repuesto		
------------	---	--	--



243-046-22	CONE bis 12 mm up to 12 mm a 12 mm	22,5 cm; 8 7/8"	
------------	---	-----------------	--



243

Schädelhalter
 Skull traction tongs
 Estribos de tracción craneal

Art.Nr.	Beschreibung Description	Size	Spez.
---------	----------------------------	------	-------

243-050-01	CRUTCHFIELD bis 105 mm up to 105 mm a 105 mm		
------------	---	--	--



243-050-02	CRUTCHFIELD bis 155 mm up to 155 mm a 155 mm		
------------	---	--	--



	Vorbohrer drill point perforador		
--	--	--	--

		7,0cm; 2 6/8"	
--	--	---------------	--

243-051-35	Ø 3,5 mm		
------------	----------	---	--

243-051-50	Ø 5,0 mm		
------------	----------	---	--

Schädelhalter
Skull traction tongs
Estribos de tracción craneal



Art.Nr.	Beschreibung Description	Size	Spez.
243-055-00	bis 175 mm up to 175 mm a 175 mm		



243-055-01	Ersatzdorn Spare pin Espina de repuesto
------------	---



Hirnretraktor
Brain retractor
Separadores cerebrales

Art.Nr.	Beschreibung Description	Size	Spez.
243-070-00	LEYLA		SET

1-Arm | with 1 arm | con 1 brazo

bestehend aus: | consisting of: | compuesto de:

1x 243-070-10 Spannarm | Flexible arm | Brazo

1x 243-070-20 Fixiervorrichtung | Fixation base | Fijador

1x 243-070-31 Spatelhalter | Support | Porta-espátula



243-071-00	LEYLA		SET
------------	-------	--	-----

2-Arm | with 2 arms | con 2 brazos

bestehend aus: | consisting of: | compuesto de:

2x 243-070-10 Spannarm | Flexible arm | Brazo

1x 243-070-21 Fixiervorrichtung | Fixation base | Fijador

2x 243-070-31 Spatelhalter | Support | Porta-espátula

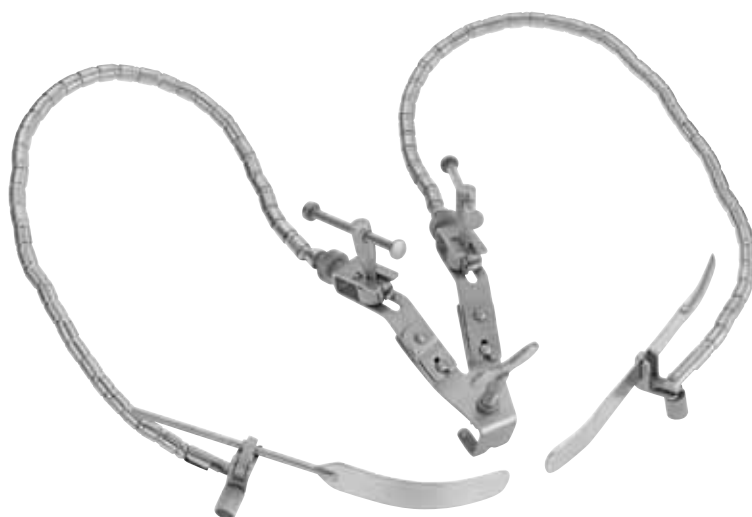

Hirnretraktor
Brain retractor
Separador cerebro



Art.Nr.	Beschreibung Description	Size	Spez.
---------	----------------------------	------	-------

243-075-00	LEYLEA 1-Arm with 1 arm con 1 brazo		SET
------------	--	--	------------

bestehend aus: | consisting of: | compuesto de:
1 x 243-073-10; 243-073-20; 243-073-31; 243-070-10; 243-070-30

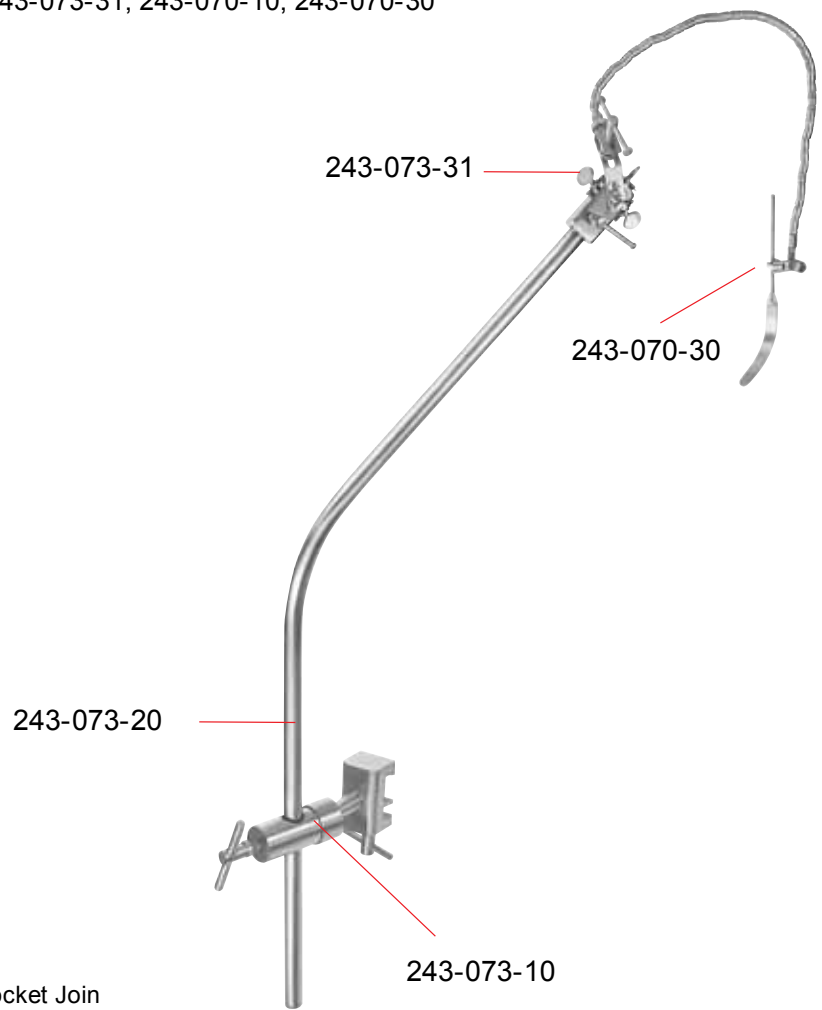

243-073-10	Kugelgelenkkolben Ball and Socket Join zapato p.la f jacion
------------	--

243-073-20	Haltearm holding rod brazo
------------	---------------------------------

243-073-31	Kupplungskopf Coupling head Acoplamiento
------------	---

243-070-10	Spannarm Flexible arm Brazo
------------	----------------------------------

243-070-30	Spatelhalter Support Porta-espátula
------------	--

243

Hirnretraktor
Brain retractor
Separador cerebro

Art.Nr.	Beschreibung Description	Size	Spez.
---------	----------------------------	------	-------

243-077-00	LEYLEA 2-Arm with 2 arms con 2 brazos		SET
------------	--	--	------------

bestehend aus: | consisting of: | compuesto de:
1 x 243-073-10; 1 x 243-073-20; 2 x 243-073-31; 2 x 243-070-10; 1 x 243-070-30; 1 x 243-070-31

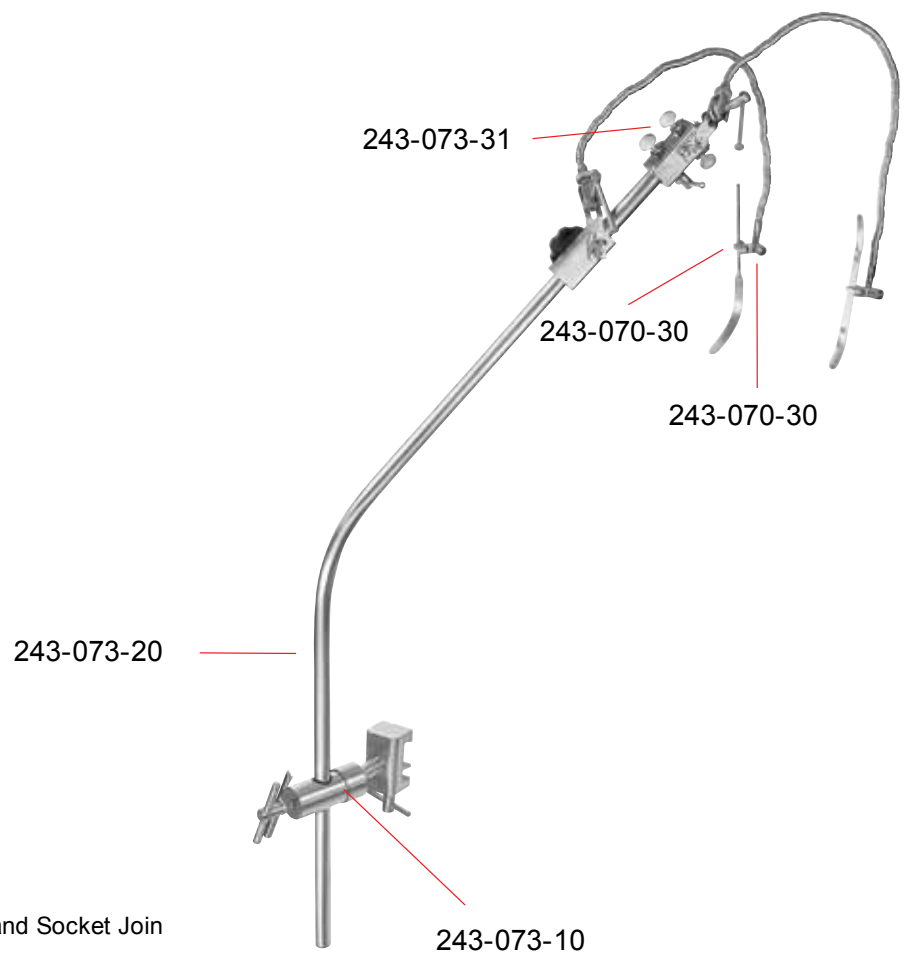

243-073-10	Kugelgelenkkolben Ball and Socket Join zapato p.la f jacion
------------	--

243-073-20	Haltearm holding rod brazo
------------	---------------------------------

243-073-31	Kupplungskopf Coupling head Acoplamiento
------------	---







243-070-10	Spannarm Flexible arm Brazo
------------	----------------------------------

243-070-30	Spatelhalter Support Porta-espátula
------------	--

243-070-31	Spatelhalter Support Porta-espátula
------------	--

Hirnretraktor
Brain retractor
Separador cerebro



Art.Nr.	Beschreibung Description	Size	Spez.
243-070-10	Spannarm flexible arm brazo		
243-070-20	Fixiervorrichtung für 1 Arm zum Festschrauben am Schädel fixation base for 1 arm at skull fijador para 1 brazo al craneo		
243-070-21	Fixiervorrichtung für 2 Arme zum Festschrauben am Schädel fixation base for 2 arms at skull fijador para 2 brazos al craneo		
243-070-22	Fixiervorrichtung für 1 Arm zum Festschrauben am Starrarm fixation base for 1 arm at rigid arm fijador para 1 brazo al brazo rígido		
243-070-30	Halter für Hirnspatel mit rundem Schaft holder for brain spatula with round stem soporte para espátulas con vástago redondo		
243-070-31	Halter für flache Hirnspatel holder for flat brain spatula soporte para espátulas llanas		

244

Hirnretraktor
Brain retractor
Separador cerebro

Art.Nr.	Beschreibung Description	Size	Spez.
---------	----------------------------	------	-------

HEIFETZ

20,0cm; 7 7/8"

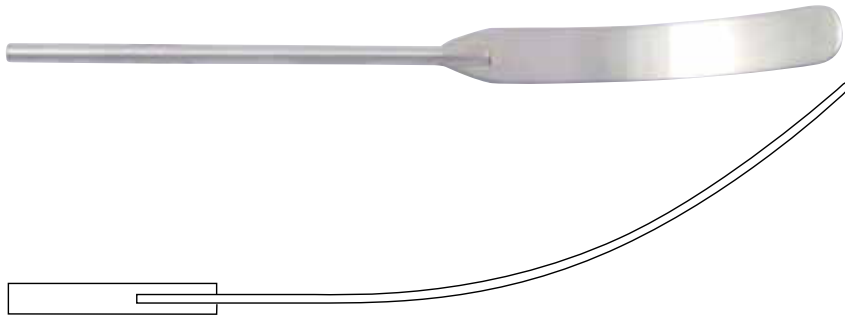

- 243-130-08 8,0 mm
- 243-130-11 11,0 mm
- 243-130-14 14,0 mm
- 243-130-17 17,0 mm
- 243-130-20 20,0 mm

HEIFETZ

15,5cm; 6 1/8"



- 243-132-08 8,0 mm
- 243-132-11 11,0 mm
- 243-132-14 14,0 mm
- 243-132-17 17,0 mm

OLIVECRONA

18,0cm; 7"

konkav | concave | concáva

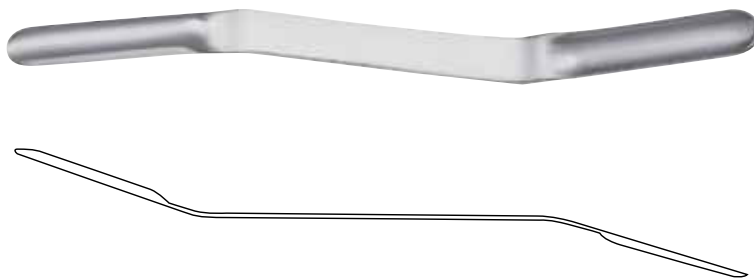

- 243-136-01 7 + 9 mm
- 243-136-02 11 + 13 mm
- 243-136-03 15 + 18 mm
- 243-136-04 19 + 21 mm

Hirnspatel
Brain spatulas
Espátulas cerebrales



Art.Nr.	Beschreibung Description	Size	Spez.
---------	----------------------------	------	-------

OLIVECRONA

18,0cm; 7"

konvex | convex | convexo

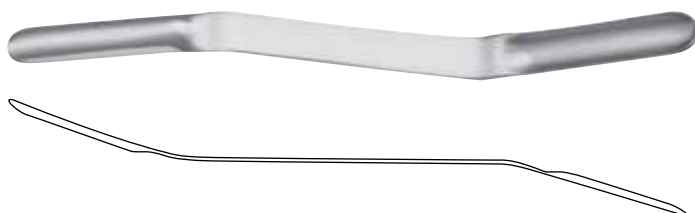

- 243-138-01 7 + 9 mm
- 243-138-02 11 + 13 mm
- 243-138-03 15 + 18 mm
- 243-138-04 19 + 21 mm

biegsam | malleable | maleable

20,0cm; 7 7/8"



- 243-146-12 12,0 mm
- 243-146-17 17,0 mm

CUSHING

19,5cm; 7 5/8"
10 + 12 mm

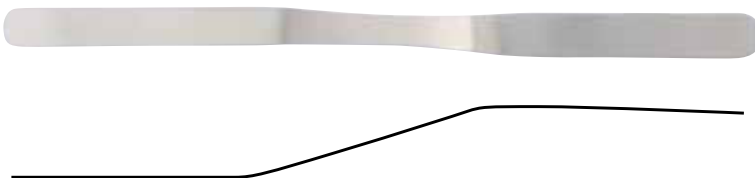

243

Nervwurzelnhaken
 Nerve root retractors
 Separadores para la raíz nervio

Art.Nr.	Beschreibung Description	Size	Spez.
---------	----------------------------	------	-------

243-200-20

HORSLEY

20,0cm; 7 7/8"

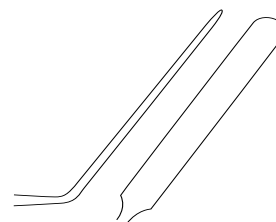

243-202-21

SACHS

21,0cm; 8 2/8"

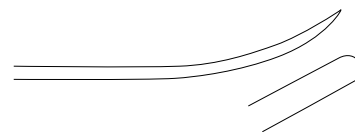

243-203-07

HOLSHER

21,0cm; 8 2/8"

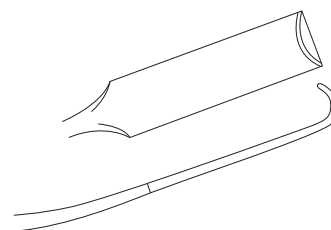

243-205-23

SCOVILLE

23,0cm; 9"
8,0 mm

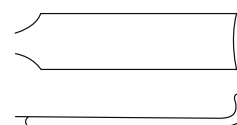

Nervwurzelhaken
Nerve root retractors
Separadores para la raíz nervio



Art.Nr. Beschreibung | Description Size Spez.

243-207-00 LOVE 21,5cm; 8 4/8"



243-207-45 LOVE 17,5cm; 6 7/8" 45°



243-207-90 LOVE 11,0cm; 4 3/8" 90°



243-208-22 LOVE 21,0cm; 8 2/8"



243-213-20 SCOVILLE 20,0cm; 7 7/8" 8,0 mm



243

Nervhaken; Durahaken
Nerve hooks; Dura hooks
Ganchos para nervios; Ganchos para duramadre

Art.Nr.	Beschreibung Description	Size	Spez.
243-217-17	SMITHWICK	16,5cm; 6 4/8"	



243-217-21	SMITHWICK	21,0cm; 8 4/8"	
------------	-----------	----------------	--



243-221-14	CUSHING	14,5cm; 5 6/8"	
------------	---------	----------------	--



Duradissektoren
 Dura dissectors
 Disecadores para duramadre



Art.Nr.	Beschreibung Description	Size	Spez.
---------	----------------------------	------	-------

SACHS

21,0cm; 8 4/8"

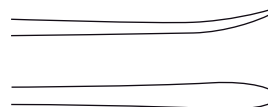

243-228-21



243-230-21



243-231-15

FRAZIER

16,5cm; 6 4/8"

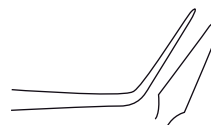

OLIVECRONA



243-234-18

18,0cm; 7 1/8"

243-234-24

24,0cm; 9 4/8"

OLIVECRONA

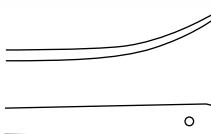

243-235-19

19,5cm; 7 5/8"

243-235-24

24,0cm; 9 4/8"

243

Duradissektoren
Dura dissectors
Disecadores para duramadre

Art.Nr.	Beschreibung Description	Size	Spez.
243-236-21	MILLIGAN	21,0cm; 8 4/8"	

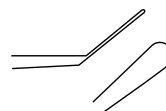

243-237-22		22,0cm; 8 5/8"	
------------	--	----------------	--



243-238-01	TOENNIS	24,0cm; 9 4/8"	
------------	---------	----------------	--



243-239-24	DAVIS	24,5cm; 9 5/8"	
------------	-------	----------------	--



Duradissektoren
 Dura dissectors
 Disecadores para duramadre



Art.Nr.	Beschreibung Description	Size	Spez.
---------	----------------------------	------	-------

PENFIELD

243-240-01	Fig. 1 17,5cm; 6 7/8"		
------------	-----------------------	--	--



243-240-02	Fig. 2 19,5cm; 7 5/8"		
------------	-----------------------	--	--



243-240-03	Fig. 3 19,5cm; 7 5/8"		
------------	-----------------------	--	--



243-240-04	Fig. 4 20,5cm; 8 1/8"		
------------	-----------------------	--	--



243-240-05	Fig. 5 18,5cm; 7 2/8"		
------------	-----------------------	--	--



243

Laminektomie-Wundspreizer
 Laminectomy Rongeurs
 Separadores para laminectomía

Art.Nr. Beschreibung | Description Size Spez.

CASPAR

SET



243-350-00 Wundspreizer, bestehend aus:
 243-350-01 1 Rahmen
 243-350-10 1 Drehschlüssel
 243-351-38 1 Haken 38 mm
 243-352-37 1 Seitenvalven 37 x 22 mm
 243-352-43 1 Seitenvalven 43 x 22 mm
 243-352-47 1 Seitenvalven 47 x 22 mm
 243-352-52 1 Seitenvalven 52 x 22 mm
 243-352-57 1 Seitenvalven 57 x 22 mm

243-350-00 Separadores, compuesto de:
 243-350-01 1 cuadro
 243-350-10 1 llave
 243-351-38 1 ganchos 38 mm
 243-352-37 1 valvas laterales 37 x 22 mm
 243-352-43 1 valvas laterales 43 x 22 mm
 243-352-47 1 valvas laterales 47 x 22 mm
 243-352-52 1 valvas laterales 52 x 22 mm
 243-352-57 1 valvas laterales 57 x 22 mm



243-350-00 Wound Spreaders, consisting of:
 243-350-01 1 frame
 243-350-10 1 key
 243-351-38 1 hooks 38 mm
 243-352-37 1 lateral blades 37 x 22 mm
 243-352-43 1 lateral blades 43 x 22 mm
 243-352-47 1 lateral blades 47 x 22 mm
 243-352-52 1 lateral blades 52 x 22 mm
 243-352-57 1 lateral blades 57 x 22 mm

Laminektomie-Wundspreizer
 Laminectomy Rongeurs
 Separadores para laminectomía



Art.Nr.	Beschreibung Description	Size	Spez.
243-350-10	Drehschlüssel key llave		

CASPAR Haken
 hooks
 ganchos

243-351-38	38,0 mm		
243-351-58	58,0 mm		

243

Laminektomie-Wundspreizer
 Laminectomy Rongeurs
 Separadores para laminectomía

Art.Nr. Beschreibung | Description Size Spez.

CASPAR

- 243-352-32 32 x 22 mm
- 243-352-37 37 x 22 mm
- 243-352-43 43 x 22 mm
- 243-352-47 47 x 22 mm
- 243-352-52 52 x 22 mm
- 243-352-57 57 x 22 mm
- 243-352-62 62 x 22 mm
- 243-352-67 67 x 22 mm



CASPAR

- 243-353-32 32 x 37 mm
- 243-353-37 37 x 37 mm
- 243-353-43 43 x 37 mm
- 243-353-47 47 x 37 mm
- 243-353-52 52 x 37 mm
- 243-353-62 62 x 37 mm
- 243-353-67 67 x 37 mm



CASPAR

- 243-354-32 32 x 52 mm
- 243-354-37 37 x 52 mm
- 243-354-43 43 x 52 mm
- 243-354-47 47 x 52 mm
- 243-354-52 52 x 52 mm
- 243-354-62 62 x 52 mm
- 243-354-67 67 x 52 mm



Cervicalspreizer
Cervical Retractor
Separador cervical



Art.Nr. Beschreibung | Description Size Spez.

CASPAR

SET



243-360-00 Wundspreizer, bestehend aus:
243-360-01 1 Rahmen
243-361-40 1 Valve medial 40 x 23 mm
243-361-45 1 Valve medial 45 x 23 mm
243-361-50 1 Valve medial 50 x 23 mm
243-361-55 1 Valve medial 55 x 23 mm
243-361-60 1 Valve medial 60 x 23 mm
243-363-40 1 Valve lateral 40 x 23 mm
243-363-45 1 Valve lateral 45 x 23 mm
243-363-50 1 Valve lateral 50 x 23 mm
243-363-55 1 Valve lateral 55 x 23 mm
243-363-60 1 Valve lateral 60 x 23 mm

243-360-00 Separadores, compuesto de:
243-360-01 1 cuadro
243-361-40 1 valva medial 40 x 23 mm
243-361-45 1 valva medial 45 x 23 mm
243-361-50 1 valva medial 50 x 23 mm
243-361-55 1 valva medial 55 x 23 mm
243-361-60 1 valva medial 60 x 23 mm
243-363-40 1 valva lateral 40 x 23 mm
243-363-45 1 valva lateral 45 x 23 mm
243-363-50 1 valva lateral 50 x 23 mm
243-363-55 1 valva lateral 55 x 23 mm
243-363-60 1 valva lateral 60 x 23 mm

243-360-00 Wound Spreaders, consisting of:
243-360-01 1 frame
243-361-40 1 valve medial 40 x 23 mm
243-361-45 1 valve medial 45 x 23 mm
243-361-50 1 valve medial 50 x 23 mm
243-361-55 1 valve medial 55 x 23 mm
243-361-60 1 valve medial 60 x 23 mm
243-363-40 1 valve lateral 40 x 23 mm
243-363-45 1 valve lateral 45 x 23 mm
243-363-50 1 valve lateral 50 x 23 mm
243-363-55 1 valve lateral 55 x 23 mm
243-363-60 1 valve lateral 60 x 23 mm

243

Cervicalspreizer
 Cervical Retractor
 Separador cervical

Art.Nr.	Beschreibung Description	Size	Spez.
---------	----------------------------	------	-------

CASPAR
 medial | medial | medial

- 243-361-40 40 x 23 mm
- 243-361-45 45 x 23 mm
- 243-361-50 50 x 23 mm
- 243-361-55 55 x 23 mm
- 243-361-60 60 x 23 mm



CASPAR
 lateral | lateral | lateral

- 243-363-40 40 x 23 mm
- 243-363-45 45 x 23 mm
- 243-363-50 50 x 23 mm
- 243-363-55 55 x 23 mm
- 243-363-60 60 x 23 mm



CASPAR
 stumpf | blunt | romo

- 243-365-40 40 x 23 mm
- 243-365-45 45 x 23 mm
- 243-365-50 50 x 23 mm
- 243-365-55 55 x 23 mm
- 243-365-60 60 x 23 mm
- 243-365-65 65 x 23 mm



CASPAR
 stumpf | blunt | romo

- 243-367-50 50 x 25 mm
- 243-367-60 60 x 25 mm



Cervicalspreizer
 Cervical Retractor
 Separador cervical



Art.Nr.	Beschreibung Description	Size	Spez.
243-368-12	Pinzette zum Valvenwechseln forceps for changing blades pinza para cambiar las valvas	11,5cm; 4 1/2"	



CASPAR

SET



243-370-00	bestehend aus:	243-370-00	compuesto de:
243-370-01	1 Sperrer	243-370-01	1 separador
243-365-45	1 Valve stumpf 45 x 23 mm	243-365-45	1 valva romo 45 x 23 mm
243-365-50	1 Valve stumpf 50 x 23 mm	243-365-50	1 valva romo 50 x 23 mm
243-365-55	1 Valve stumpf 55 x 23 mm	243-365-55	1 valva romo 55 x 23 mm
243-365-60	1 Valve stumpf 60 x 23 mm	243-365-60	1 valva romo 60 x 23 mm
243-365-65	1 Valve stumpf 65 x 23 mm	243-365-65	1 valva romo 65 x 23 mm

243-370-00	consisting of:
243-370-01	1 spreader
243-365-45	1 valve blunt 45 x 23 mm
243-365-50	1 valve blunt 50 x 23 mm
243-365-55	1 valve blunt 55 x 23 mm
243-365-60	1 valve blunt 60 x 23 mm
243-365-65	1 valve blunt 65 x 23 mm

243

Cervicalspreizer
 Cervical Retractor
 Separador cervical

Art.Nr.	Beschreibung Description	Size	Spez.
---------	----------------------------	------	-------

CASPAR

SET



243-380-00 bestehend aus:
 243-380-01 1 Sperrer
 243-365-45 1 Valve stumpf 45 x 23 mm
 243-365-50 1 Valve stumpf 50 x 23 mm
 243-365-55 1 Valve stumpf 55 x 23 mm
 243-365-60 1 Valve stumpf 60 x 23 mm
 243-365-65 1 Valve stumpf 65 x 23 mm

243-380-00 compuesto de:
 243-380-01 1 separador
 243-365-45 1 valva romo 45 x 23 mm
 243-365-50 1 valva romo 50 x 23 mm
 243-365-55 1 valva romo 55 x 23 mm
 243-365-60 1 valva romo 60 x 23 mm
 243-365-65 1 valva romo 65 x 23 mm

243-370-00 consisting of:
 243-370-01 1 spreader
 243-365-45 1 valve blunt 45 x 23 mm
 243-365-50 1 valve blunt 50 x 23 mm
 243-365-55 1 valve blunt 55 x 23 mm
 243-365-60 1 valve blunt 60 x 23 mm
 243-365-65 1 valve blunt 65 x 23 mm

Lumbalwundspreizer
 Lumbal Retractors
 Separadores lumbales autoestáticos



Art.Nr.	Beschreibung Description	Size	Spez.
---------	----------------------------	------	-------

CASPAR



243-390-40	40,0 mm		
243-390-45	45,0 mm		
243-390-50	50,0 mm		
243-390-55	55,0 mm		
243-390-60	60,0 mm		

243

Lumbalwundspreizer
 Lumbal Retractors
 Separadores lumbales autoestáticos

Art.Nr. Beschreibung | Description Size Spez.

CASPAR



SET

243-410-00	bestehend aus:	243-410-00	Separadores, compuesto de:
243-410-01	1 Rahmen	243-410-01	1 cuadro
243-413-35	1 Seitenvlve 35 x 12 mm	243-413-35	1 valvas laterales 35 x 12 mm
243-413-40	1 Seitenvlve 40 x 13 mm	243-413-40	1 valvas laterales 40 x 13 mm
243-413-45	1 Seitenvlve 45 x 13 mm	243-413-45	1 valvas laterales 45 x 13 mm
243-413-50	1 Seitenvlve 50 x 14 mm	243-413-50	1 valvas laterales 50 x 14 mm
243-413-55	1 Seitenvlve 55 x 14 mm	243-413-55	1 valvas laterales 55 x 14 mm
243-413-60	1 Seitenvlve 60 x 15 mm	243-413-60	1 valvas laterales 60 x 15 mm

243-410-00	consisting of:
243-410-01	1 frame
243-413-35	1 lateral blades 35 x 12 mm
243-413-40	1 lateral blades 40 x 13 mm
243-413-45	1 lateral blades 45 x 13 mm
243-413-50	1 lateral blades 50 x 14 mm
243-413-55	1 lateral blades 55 x 14 mm
243-413-60	1 lateral blades 60 x 15 mm

Lumbalwundspreizer
 Lumbal Retractors
 Separadores lumbales autoestáticos



Art.Nr.	Beschreibung Description	Size	Spez.
---------	----------------------------	------	-------

CASPAR

lateral | lateral | lateral

- 243-413-35 35 x 12 mm
- 243-413-40 40 x 13 mm
- 243-413-45 45 x 13 mm
- 243-413-50 50 x 14 mm
- 243-413-55 55 x 14mm
- 243-413-60 60 x 15mm



CASPAR

medial | medial | medial

- 243-414-35 35 x 12 mm
- 243-414-40 40 x 13 mm
- 243-414-45 45 x 13 mm
- 243-414-50 50 x 14 mm
- 243-414-55 55 x 14mm
- 243-414-60 60 x 15mm



243

Lumbalwundspreizer
 Lumbal Retractors
 Separadores lumbales autoestáticos

Art.Nr.	Beschreibung Description	Size	Spez.
---------	----------------------------	------	-------

SCOVILLE

SET



243-415-00 Wundspreizer, bestehend aus:
 243-415-01 1 Rahmen
 243-421-50 1 Haken 50 mm
 243-423-01 1 Seitenvalven 63 x 25 mm

243-415-00 Separadores, compuesto de:
 243-415-01 1 cuadro
 243-421-50 1 ganchos 50 mm
 243-423-01 1 valvas laterales 63 x 25 mm

243-350-00 Wound Spreaders, consisting of:
 243-415-01 1 frame
 243-421-50 1 hooks 50 mm
 243-423-01 1 lateral blades 63 x 25 mm

Laminektomie-Wundspreizer
Laminectomy Rongeurs
Separadores para laminectomía



Art.Nr. Beschreibung | Description Size Spez.

SCOVILLE-HAVERFIELD mit Gelenkarmen
with articulated arms
con brazos articulados

SET



243-420-00 Wundspreizer, bestehend aus:
243-420-01 1 Rahmen
243-421-50 1 Haken 50 mm
243-423-01 1 Seitenvalven 63 x 25 mm

243-420-00 Separadores, compuesto de:
243-420-01 1 cuadro
243-421-50 1 ganchos 50 mm
243-423-01 1 valvas laterales 63 x 25 mm

243-350-00 Wound Spreaders, consisting of:
243-420-01 1 frame
243-421-50 1 hooks 50 mm
243-423-01 1 lateral blades 63 x 25 mm

SCOVILLE

243-421-50 50,0 mm

243-421-75 75,0 mm







SCOVILLE

243-422-50 50,0 mm

243-422-75 75,0 mm



Laminektomie-Wundspreizer
 Laminectomy Rongeurs
 Separadores para laminectomía

Art.Nr.	Beschreibung Description	Size	Spez.
SCOVILLE			
243-423-01	63 x 25 mm		
243-423-02	63 x 51 mm		
243-423-03	67 x 32 mm		
TAYLOR			
243-425-03	47 x 37 mm		
243-425-04	63 x 51 mm		
243-427-01	48 x 50 mm		
243-427-03	64 x 63 mm		
243-427-04	80 x 57 mm		
243-450-00	BADGLEY	52 x 44 mm	

Cervicalspreizer
Cervical Retractor
Separador cervical



Art.Nr.	Beschreibung Description	Size	Spez.
---------	----------------------------	------	-------

CLOWARD

25,0cm; 10"

SET

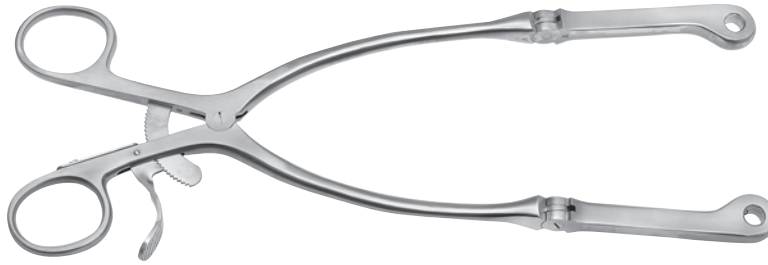

243-460-00 Wundspreizer bestehend aus:
 243-460-01 1 Sperrer
 243-461-40 1 gezahnte Seitenvalse 40 x 15 - 23 mm
 243-461-45 1 gezahnte Seitenvalse 45 x 15 - 23 mm
 243-461-50 1 gezahnte Seitenvalse 50 x 15 - 23 mm
 243-461-55 1 gezahnte Seitenvalse 55 x 15 - 23 mm
 243-461-60 1 gezahnte Seitenvalse 60 x 15 - 23 mm

243-460-00 Separador, compuesto de:
 243-460-01 1 separador
 243-461-40 1 valva lateral, dentada, 40 x 15 - 23 mm
 243-461-45 1 valva lateral, dentada, 45 x 15 - 23 mm
 243-461-50 1 valva lateral, dentada, 50 x 15 - 23 mm
 243-461-55 1 valva lateral, dentada, 55 x 15 - 23 mm
 243-461-60 1 valva lateral, dentada, 60 x 15 - 23 mm

243-460-00 self-retaining retractor, consisting of:
 243-460-01 1 spreader
 243-461-40 1 lateral valve, serrated, 40 x 15 - 23 mm
 243-461-45 1 lateral valve, serrated, 45 x 15 - 23 mm
 243-461-50 1 lateral valve, serrated, 50 x 15 - 23 mm
 243-461-55 1 lateral valve, serrated, 55 x 15 - 23 mm
 243-461-60 1 lateral valve, serrated, 60 x 15 - 23 mm

243-461-40 40 x 15 - 23 mm



243-461-55 55 x 15 - 23 mm



243-461-45 45 x 15 - 23 mm



243-461-60 60 x 15 - 23 mm



243-461-50 50 x 15 - 23 mm



Cervicalspreizer
Cervical Retractor
Separador cervical

Art.Nr.	Beschreibung Description	Size	Spez.
	CLOWARD	13,0cm; 5 1/8"	SET



- 243-465-00 Wundspreizer, bestehend aus:
 243-465-01 1 Sperrer
 243-462-40 1 stumpfe Seitenvalve 40 x 15 - 23 mm
 243-462-45 1 stumpfe Seitenvalve 45 x 15 - 23 mm
 243-462-50 1 stumpfe Seitenvalve 50 x 15 - 23 mm
 243-462-55 1 stumpfe Seitenvalve 55 x 15 - 23 mm
 243-462-60 1 stumpfe Seitenvalve 60 x 15 - 23 mm

- 243-465-00 Separador, compuesto de:
 243-465-01 1 separador
 243-462-40 1 valva lateral, roma, 40 x 15 - 23 mm
 243-462-45 1 valva lateral, roma, 45 x 15 - 23 mm
 243-462-50 1 valva lateral, roma, 50 x 15 - 23 mm
 243-462-55 1 valva lateral, roma, 55 x 15 - 23 mm
 243-462-60 1 valva lateral, roma, 60 x 15 - 23 mm

- 243-465-00 Self-retaining retractor, consisting of:
 243-465-01 1 spreader
 243-462-40 1 lateral valve, blunt, 40 x 15 - 23 mm
 243-462-45 1 lateral valve, blunt, 45 x 15 - 23 mm
 243-462-50 1 lateral valve, blunt, 50 x 15 - 23 mm
 243-462-55 1 lateral valve, blunt, 55 x 15 - 23 mm
 243-462-60 1 lateral valve, blunt, 60 x 15 - 23 mm

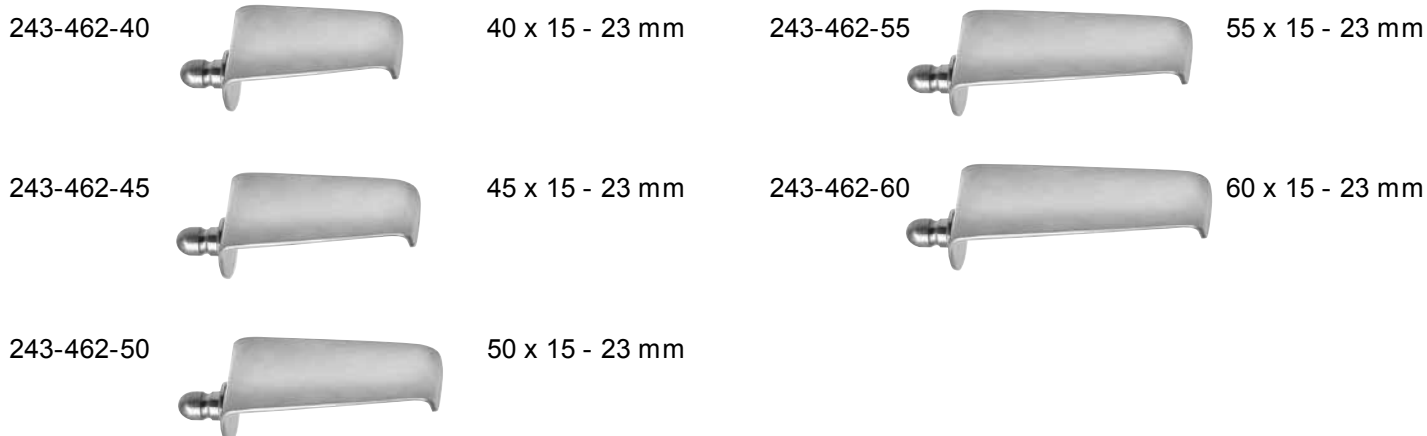

Wirbelkörperspreizer
 Lamina spreaders
 Separadores cuerpos vertebrales



Art.Nr.	Beschreibung Description	Size	Spez.
---------	----------------------------	------	-------

243-473-13	CLOWARD Spreizweite 18 mm spreading 18 mm extensión 18 mm	13,0cm; 5 1/8"	
------------	--	----------------	--



243-482-16	CLOWARD Spreizweite 18 mm spreading 18 mm extensión 18 mm	16,0cm; 6 2/8"	
------------	--	----------------	--



243-497-17	INGE Spreizweite 35 mm spreading 35 mm extensión 35 mm	16,0cm; 6 2/8"	
------------	---	----------------	--



243-498-27	INGE Spreizweite 70 mm spreading 70 mm extensión 70 mm	25,5cm; 10"	
------------	---	-------------	--



243

Mikro-Pinzetten; Tumorfaßpinzetten
 Micro forceps; Tumor grasping forceps
 Micro Pinzas; Pinzas para agarrar tumores

Art.Nr.	Beschreibung Description	Size	Spez.
---------	----------------------------	------	-------

YASARGIL



243-510-18	0,6mm	18,0cm; 7 1/8"	
243-510-20	0,6mm	20,0cm; 7 7/8"	
243-510-22	0,6mm	22,0cm; 8 5/8"	
243-510-24	0,6mm	24,0cm; 9 4/8"	



243-512-18	0,9mm	18,0cm; 7 1/8"	
243-512-20	0,9mm	20,0cm; 7 7/8"	
243-512-22	0,9mm	22,0cm; 8 5/8"	
243-512-24	0,9mm	24,0cm; 9 4/8"	



243-515-18	 1x2	18,0cm; 7 1/8"	
------------	---	----------------	--



YASARGIL

22,0cm; 8 5/8"

243-520-03	Ø 3,0mm	
------------	---------	---

243-520-05	Ø 5,0mm	
------------	---------	---

YASARGIL-SAMII

24,0cm; 9 4/8"

243-522-03	Ø 3,0mm	
------------	---------	---

243-522-05	Ø 5,0mm	
------------	---------	---

243-522-07	Ø 7,0mm	
------------	---------	---

Tumorfaßpinzetten
 Tumor grasping forceps
 Pinzas para agarrar tumores



Art.Nr.	Beschreibung Description	Size	Spez.
---------	----------------------------	------	-------



YASARGIL

22,0cm; 8 5/8"

243-524-03	Ø 3,0mm	
------------	---------	--

243-524-05	Ø 5,0mm	
------------	---------	--

YASARGIL-SAMII

22,0cm; 8 5/8"

243-526-03	Ø 3,0mm	
------------	---------	--

243-526-05	Ø 5,0mm	
------------	---------	--

SAMII

23,0cm; 9"



243-527-03	Ø 3,0mm	
------------	---------	--

243-529-03	Ø 3,0mm	
------------	---------	--

243-527-04	Ø 4,0mm	
------------	---------	--

243-529-04	Ø 4,0mm	
------------	---------	--

243-527-05	Ø 5,0mm	
------------	---------	--

243-529-05	Ø 5,0mm	
------------	---------	--

243

Mikro-Knüpfpinzetten
 Micro suture tying forceps
 Micro Pinza para enlazar

Art.Nr.	Beschreibung Description	Size	Spez.
---------	----------------------------	------	-------

18,5cm; 7 2/8"



243-516-03	0,3mm	
243-516-06	0,6mm	
243-517-06	0,6mm	



243-550-12	0,3mm	12,0cm; 4 6/8"		
243-550-15	0,3mm	15,0cm; 5 7/8"		
243-550-18	0,3mm	18,0cm; 7 1/8"		
243-550-21	0,3mm	21,0cm; 8 2/8"		
243-551-12	0,3mm	12,0cm; 4 6/8"		
243-551-15	0,3mm	15,0cm; 5 7/8"		
243-551-18	0,3mm	18,0cm; 7 1/8"		
243-551-21	0,3mm	21,0cm; 8 2/8"		
243-560-12	0,3mm	12,0cm; 4 6/8"		1x2
243-560-15	0,3mm	15,0cm; 5 7/8"		
243-560-18	0,3mm	18,0cm; 7 1/8"		
243-561-12	0,3mm	12,0cm; 4,8"		1x2
243-561-15	0,3mm	15,0cm; 5 7/8"		
243-561-18	0,3mm	18,0cm; 7 1/8"		

Mikro-Knüpfpinzetten
 Micro suture tying forceps
 Micro Pinza para enlazar



Art.Nr.	Beschreibung Description	Size	Spez.
243-570-23		23,0cm; 9" 0,6mm	



AUSTIN



243-572-14	0,8mm	14,0cm; 5 4/8"
------------	-------	----------------



243-572-18	0,8mm	18,0cm; 7 1/8"
------------	-------	----------------



243-574-12		12,0cm; 4 6/8" 0,3mm
------------	--	-------------------------

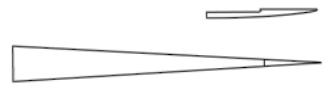

243-576-13	VISE	13,5cm; 5 3/8" 0,3mm
------------	------	-------------------------



243

Mikro-Knüpfpinzetten
 Micro suture tying forceps
 Micro Pinza para enlazar

Art.Nr.	Beschreibung Description	Size	Spez.
243-577-13	VISE	13,5cm; 5 3/8 0,3mm	



LAZAR

15,5cm; 6 1/8"



243-578-05 0,5mm



243-578-08 0,8mm



243-580-18

18,5cm; 7 2/8"
0,5mm





Art.Nr.	Beschreibung Description	Size	Spez.
---------	----------------------------	------	-------

23,0cm; 9"



243-620-01 halbscharf | semi-sharp | agudo



243-620-02 stumpf | blunt | romo



243-621-01



243-621-02



243-622-01



243-622-02

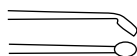

243-623-01

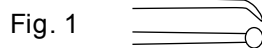

243-623-02

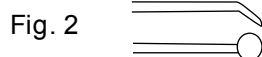

23,0cm; 9"



Dissektor | Dissector | Disecador

243-635-01



243-635-02



Raspatorium | Periosteal elevator | Legra

243-635-03

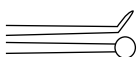

243

Art.Nr.	Beschreibung Description	Size	Spez.
	CASPAR Explorationshaken; isoliert exploration hook; insulated ganchos para exploración; aislados	25,0cm; 10"	

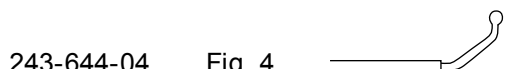
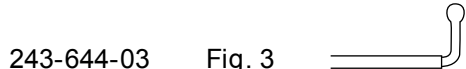
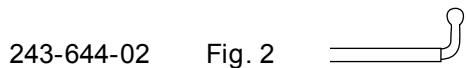
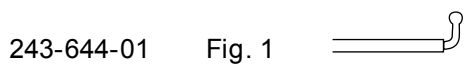





Art.Nr.	Beschreibung Description	Size	Spez.
	YASARGIL	18,5cm; 7 2/8"	

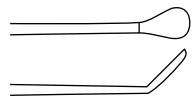

243-660-01 1,0 mm 

243-660-02 2,5 mm 

243-660-03 Ø 4,0 mm 

243-660-04 2,5 mm 

243-660-05 3,0 mm 

243

Art.Nr. Beschreibung | Description Size Spez.

YASARGIL

18,5cm; 7 2/8"



243-661-01



243-661-03

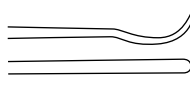

243-661-02



243-663-19

YASARGIL

18,5cm; 7 2/8"

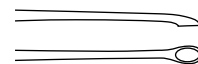

KOOS

18,5cm; 7 2/8"



243-665-01

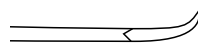

243-665-02

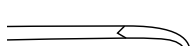

243-667-01

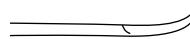

243-667-02



243-669-01

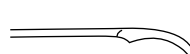

243-669-02

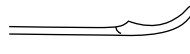

YASARGIL

18,5cm; 7 2/8"



243-673-01

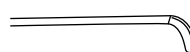

243-673-02





Art.Nr.	Beschreibung Description	Size	Spez.
---------	----------------------------	------	-------

JACOBSON

18,5cm; 7 2/8"



243-676-19

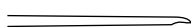

243-677-02

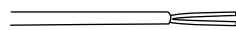

243-677-01



243-679-18



YASARGIL Fadenführer; geknöpft
 ligature guide and carrier; pointed
 guía-ligadura; abotonada

18,5cm; 7 2/8"



243-685-01

Fig. 1



243-685-03

Fig. 3



243-685-02

Fig. 2

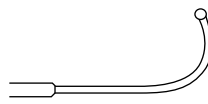

243-685-04

Fig. 4

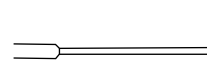

243-687-19

Gewebekralle
 Tissue claw
 Garra para el tejido

18,5cm; 7 2/8"
 Ø 1,5 mm



Art.Nr.	Beschreibung Description	Size	Spez.
243-730-22	YASARGIL	19,0cm; 7 4/8"	



 Ø 2,2 mm

CASPAR

25,0cm; 9 7/8"



243-800-04

4,0 mm



243-800-05

5,0 mm



CASPAR



243-801-03

3,0 mm

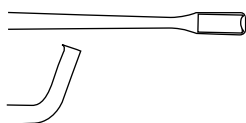

243-801-04

4,0 mm

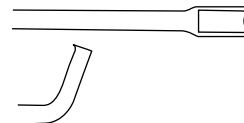



Art.Nr.	Beschreibung Description	Size	Spez.
	RAY	18,5cm; 7 2/8"	



243-810-04

Ø 4,0 mm
45°

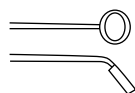

243-812-04

Ø 4,0 mm
90°

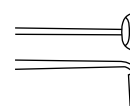

243-813-04

Ø 4,0 mm
45°



HARDY

18,5cm; 7 2/8"



243-818-04

Ø 4,0 mm
90°



243-818-06

Ø 6,0 mm
90°

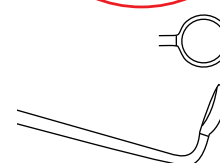

Art.Nr.	Beschreibung Description	Size	Spez.
---------	----------------------------	------	-------

24,5cm; 9 5/8"



HARDY

243-830-01 stumpf | blunt | romo



243-830-02 stumpf | blunt | romo



243-832-01 scharf | sharp | agudo



243-832-02 scharf | sharp | agudo



HARDY-FAHLBUSCH

243-840-01 scharf | sharp | agudo



243-840-02 scharf | sharp | agudo



243-836-24 HARDY

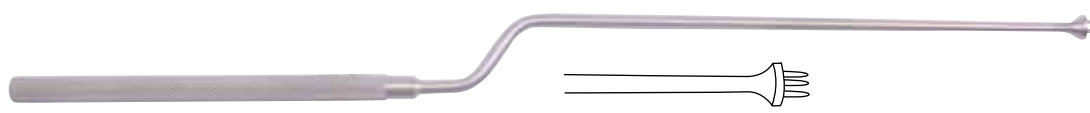

Clips und Anlegezangen
 Clips and applying forceps
 Grapas y pinzas aplicadoras



Art.Nr. Beschreibung | Description Size Spez.

MC KENZIE
 Klammeranlegezange
 clip applying forceps
 pinza para poner grapas



244-161-15 15,0cm; 5 7/8"

244-161-19 19,0cm; 7 4/8"



244-166-14 OLIVECRONA-TOENNIS Klammeranlegezange
 clip applying forceps
 pinza para poner grapas 14,0cm; 5 4/8"

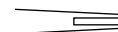

243

244-180-16 RANEY Anlege- und Abnehmzange
 applying/removal forceps
 pinza para aplicar y quitar agrafes 15,5cm; 6"



Galea Haken
Galea hooks
Galea ganchos

Art.Nr.	Beschreibung Description	Size	Spez.
---------	----------------------------	------	-------

YASARGIL



244-185-31	7,0 mm	30,0cm; 11 6/8"
------------	--------	-----------------

244-185-41	9,0 mm	41,0cm; 16 1/8"
------------	--------	-----------------

Anlegezangen für Gefäßclips
 Applying forceps for vessel clips
 Pinzas para aplicar clips vasculares

Art.Nr. Beschreibung | Description Size Spez.

YASARGIL



	Maul starr rigid jaw boca rigida
	18,0cm; 7"
MINI	244-610-18
STANDARD	244-600-18

YASARGIL



	Maul starr rigid jaw boca rigida		
	17,0cm; 6 3/4"	21,0cm; 8 1/4"	23,0cm; 9"
MINI	244-611-17	244-611-21	244-611-23
STANDARD	244-601-17	244-601-21	244-601-23

	Maul drehbar rotatable jaw boca con acogida giratoria	
	21,0cm; 8 1/4"	23,0cm; 9"
MINI	244-613-21	244-613-23
STANDARD	244-603-21	244-603-23

Anlegezangen für Gefäßclips
 Applying forceps for vessel clips
 Pinzas para aplicar clips vasculares



Art.Nr.	Beschreibung Description	Size	Spez.
	YASARGIL		



		Maul drehbar rotatable jaw boca con acogida giratoria		
		7,0cm; 2 3/4"	9,0cm; 3 1/2"	11,0cm; 4 1/3"
MINI	244-677-07	244-677-09	244-677-11	
	244-677-07T Ti	244-677-09T Ti	244-677-11T Ti	
STANDARD	244-637-07	244-637-09	244-637-11	
	244-637-07T Ti	244-637-09T Ti	244-637-11T Ti	

244

Anlegezangen für Gefäßclips; Schaft drehbar
 Applying forceps for vessel clips; shaft rotatable
 Pinzas para aplicar clips vasculares; vástago girato

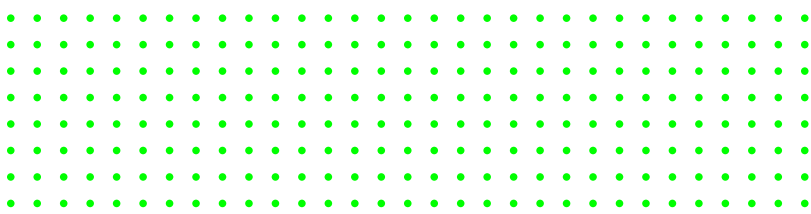

Art.Nr. Beschreibung | Description Size Spez.

YASARGIL



		Maul starr rigid jaw boca rigida			
		7,0cm; 2 3/4"	9,0cm; 3 1/2"	11,0cm; 4 1/3"	13,0cm; 5 1/8"
MINI		244-680-07	244-680-09	244-680-11	244-680-13
		244-680-07T Ti	244-680-09T Ti	244-680-11T Ti	244-680-13T Ti
STANDARD		244-640-07	244-640-09	244-640-11	244-640-13
		244-640-07T Ti	244-640-09T Ti	244-640-11T Ti	244-640-13T Ti

		Maul drehbar rotatable jaw boca con acogida giratoria			
		7,0cm; 2 3/4"	9,0cm; 3 1/2"	11,0cm; 4 1/3"	13,0cm; 5 1/8"
MINI		244-682-07	244-682-09	244-682-11	244-682-13
		244-682-07T Ti	244-682-09T Ti	244-682-11T Ti	244-682-13T
STANDARD		244-642-07	244-642-09	244-642-11	244-642-13
		244-642-07T Ti	244-642-09T Ti	244-642-11T Ti	244-642-13T

244

Weitere Artikel
further items
más artículos



Art.Nr.	Beschreibung Description	Size	Spez.
Other items available but not illustrated			
243-007-00	handle for wire saws		
	GIGLI wire saw; price per piece		
243-015-30		30,0cm; 12"	
243-015-40		40,0cm; 16"	
243-015-50		50,0cm; 20"	
243-015-60		60,0cm; 24"	
243-015-70		70,0cm; 28"	
243-040-21	DE VILBISS carnial rongeur; forceps only	21,0cm; 8,4"	
243-073-00	LEYLA brain retractor		
243-073-30	coupling head for; LEYLA brain retractor		
243-073-35	coupling head for LEYLA brain retractor; laterally open		
	brain spatulas	18,0cm; 7,2"	
243-142-01	malleable; 7+9mm		
243-142-02	malleable; 11+13mm		
243-142-03	malleable; 15+18mm		
243-142-04	malleable; 18+22mm		
	AACHEN brain spatulas	20,0cm; 8"	
243-151-08	malleable; 7+8mm		
243-151-11	malleable; 10+11mm		
243-151-14	malleable; 13+14mm		
243-151-17	malleable; 16+17mm		
243-151-20	malleable; 19+20mm		
243-151-25	malleable; 22+25mm		
	HOLSHER nerve root retractors	24,0cm; 9,6"	
243-203-09	curved; 9mm		
243-203-13	curved; 13mm		
	LOVE modif. nerve root retractors	7,0cm; 2,8"	
243-209-03	3,0mm		
243-209-05	5,0mm		
243-209-07	7,0mm		
	LOVE modif. nerve root retractors	10,0cm; 4"	
243-211-03	3,0mm		
243-211-05	5,0mm		
243-211-07	7,0mm		
243-215-21	MARTIN nerve root retractors	21,0cm; 9"	
	HOEN dura dissectors	15,0cm; 6"	
243-233-01			
243-233-02			

Weitere Artikel
further items
más artículos

Art.Nr.	Beschreibung Description	Size	Spez.
Other items available but not illustrated			
243-262-13	TOENNIS dura knife; pointed	13,0cm; 5,2"	
	disectomy retractor	17,0cm; 6,8"	
243-315-51	left; 50x10mm		
243-315-52	left; 50x20mm		
243-315-61	left; 60x10mm		
243-315-62	left; 60x20mm		
243-315-71	left; 70x10mm		
243-315-72	left; 70x20mm		
243-316-51	right; 50x10mm		
243-316-52	right; 50x20mm		
243-316-61	right; 60x10mm		
243-316-62	right; 60x20mm		
243-316-71	right; 70x10mm		
243-316-72	right; 70x20mm		
243-320-00	HEY disectomy retractor complete		
243-320-01	only		
	HEY cervical awl		
243-321-37	37mm		
243-321-53	53mm		
243-321-62	62mm		
	HEY blade		
243-323-50	sharp; 20x50mm		
243-323-60	sharp; 20x60mm		
243-323-70	sharp; 20x70mm		
243-325-50	blunt; 20x50mm		
243-325-60	blunt; 20x60mm		
243-325-70	blunt; 20x70mm		
243-351-48	CASPAR hooks; 48,0mm; for wound spreader		
	CASPAR blade		
243-353-57	57x37mm; 3 teeth		
243-354-57	57x52mm; 4 teeth		
243-354-80	80x52mm; 4 teeth		
243-360-02	CASPAR retractor; with 2 blades		
243-360-99	CASPAR Retractor Set complete		
	CASPAR blade		
243-361-65	medial; 65x25mm		
243-361-75	medial; 75x25mm		
243-361-85	medial; 85x25mm		
243-363-65	lateral; 65x25mm		
243-363-75	lateral; 75x25mm		

Weitere Artikel
further items
más artículos



Art.Nr.	Beschreibung Description	Size	Spez.
Other items available but not illustrated			
243-363-85	CASPAR blade lateral; 85x25mm		
243-380-02	CLOWARD lamina spreader		
243-385-12	CASPAR Distraction screw 12mm		
243-385-14	14mm		
243-385-16	CASPAR Distraction screw 16mm		
243-385-18	18mm		
243-385-90	CAPAR Twist drill, 1,7mm; Drilling depth 8mm, 2,35mm		
243-385-95	screw driver; for distraction screw	20,0cm; 8"	
243-390-65	CASPAR wound spreader 65mm		
243-390-70	70mm		
243-390-75	75mm		
243-390-85	80mm		
243-413-65	CASPAR blade lateral, black-coated; 65mm		
243-413-75	lateral, black-coated; 75mm		
243-413-85	lateral, black-coated; 85mm		
243-414-65	medial, black coated; 65mm		
243-414-70	medial, black coated; 70mm		
243-421-70	SCOVILLE hook blunt; 70mm		
243-422-70	70mm		
243-423-04	SCOVILLE blade; 89x25 mm		
243-430-00	SCOVILLE-RICHTER wound spreader complete		
243-430-01	only		
243-432-02	SCOVILLE-RICHTER blade; 1 pair 62x52mm		
243-433-01	47x51mm		
243-433-02	30x40mm		
243-433-03	37x62mm		
243-470-30	CLOWARD lamina spreader 30mm		
243-470-50	50mm		
243-470-60	60mm		

Weitere Artikel
further items
más artículos

Art.Nr.	Beschreibung Description	Size	Spez.
Other items available but not illustrated			
	CLOWARD lamina spreader		
243-470-75	75mm		
243-470-90	90mm		
243-471-13	127mm		
243-475-09	9,0cm; 3,6"		
243-475-11	11,0cm; 4,4"		
243-479-21	7x110mm		
	HARMS lamina spreader		
243-490-01	right		
243-490-02	left		
	INGE lamina spreader		
243-499-17	special pattern; 38mm opening	16,5cm; 6,6"	
243-499-27	screw lock instead of ratchet	27,0cm; 10,8"	
243-500-16	BADGLEY lamina speader; opening 165mm		
243-585-20	HUNT tumor grasping forceps; angled; toothed; Ø 5,0mm	20,0cm; 8"	
	RHOTON dissector	19,0cm; 7,6"	
243-610-01	round; 1mm		
243-610-02	round; 2mm		
243-610-03	round; 3mm		
243-610-04	round; 1mm; spatula shaped		
243-610-05	round; 1,5mm; spatula shaped		
243-610-06	round; 2mm; spatula shaped		
	RHOTON elevator	19,0cm; 7,6"	
243-610-07	1,2mm		
243-610-08	2,8mm		
243-610-09	semi sharp		
243-610-10	90°; 2mm; blunt		
243-610-11	90°; 2mm; semi sharp		
243-610-12	45°; 3mm; semi sharp		
243-610-13	angled		
	RHOTON curette	19,0cm; 7,6"	
243-610-14	ova; 1x2mm		
243-610-15	oval; 45°; 1x2mm		
	CASPAR micro instrument		
243-632-01		23,0cm; 9,2"	
243-632-02		23,0cm; 9,2"	
243-637-01		21,0cm; 8,4"	
243-637-02		21,0cm; 8,4"	
	micro instrument		
243-641-19	18,5cm; 7,4"		
243-641-21	21,5cm; 8,6"		

Weitere Artikel
further items
más artículos



Art.Nr.	Beschreibung Description	Size	Spez.
Other items available but not illustrated			
243-649-10 243-649-15 243-649-20 243-649-25 243-649-30 243-649-35 243-649-40 243-649-50	SAMII micro instrument	20,0cm; 8"	
243-651-10	SAMII micro tumor knife; 1,0mm; 23,0cm	23,0cm; 9,2"	
243-651-15 243-651-20	SAMII micro instrument	23,0cm; 9,2"	
243-651-25	SAMII micro tumor knife; 2,5mm	23,0cm; 9,2"	
243-651-30	SAMII micro instrument	23,0cm; 9,2"	
243-651-35	SAMII micro tumor knife; 3,5mm	23,0cm; 9,2"	
243-651-40 243-651-50	SAMII micro instrument	23,0cm; 9,2"	
243-652-15 243-652-30 243-652-45 243-652-60	SAMII micro tumor knife 1,5mm 3,0mm 4,5mm 6,0mm	23,0cm; 9,2"	
243-671-19	KRAUS micro instrument; curved; bayonet	18,5cm; 7,4"	
243-680-23	CASPAR knot tier and ligature adjuster; bayonet shape	23,0cm; 9,2"	
243-682-03 243-682-04 243-682-05 243-682-08	OKONEK-YASARGIL micro instrument 3mm 4mm 5mm 8mm		
243-690-01 243-690-02 243-690-03	Vessel dilator Ø 1,5mm Ø 0,5mm Ø 1,0mm	12,5cm; 5"	
243-710-17	FAHLBUSCH micro instrument	16,5cm; 6,6"	
243-716-30	NIKOLA micro instrument; 30° upwards; 2mm; straight; oval tip;	20,0cm; 8"	

Weitere Artikel
further items
más artículos

Art.Nr.	Beschreibung Description	Size	Spez.
Other items available but not illustrated			
243-717-16	NIKOLA micro instrument curved right; 2mm; oval tip;	20,0cm; 8"	
243-719-16	curved left; 2mm; oval tip;		
243-726-30	30° upwards; 2mm; straight; round tip;		
243-727-16	curved right; 2mm; round tip;		
243-729-16	curved left; 2mm; round tip;		
243-730-35	YASARGIL hypophysectomy spoon cup fcps Ø 3,5mm	18,0cm; 7,2"	
243-730-35CC	Ø 3,5mm; ceramic coated		
243-736-21	LANDOLT pituitary instrument; 9mm	20,0cm; 8"	
243-740-18	OLDBERG hypophysectomy forceps; Ø 7mm	18,0cm; 7,2"	
243-750-03	micro instrument 3mm	14,0cm; 5,6"	
243-750-07	7mm		
243-750-09	9mm		
243-750-12	12mm		
243-752-03	micro instrument 3mm	18,0cm; 7,2"	
243-752-07	7mm		
243-752-09	9mm		
243-752-12	12mm		
243-804-04	CONE micro curette Ø 4,0mm; straight	23,0cm; 9,2"	
243-804-07	Ø 7,0mm; straight		
243-804-09	Ø 9,0mm; straight		
243-805-04	Ø 4,0mm; angled		
243-805-07	Ø 7,0mm; angled		
243-805-09	Ø 9,0mm; angled		
243-807-04	KRÄMER hypophysectomy ring curette Ø 4,0mm; bayonet shaped	25,0cm; 10"	
243-807-05	Ø 5,0mm; bayonet shaped		
243-807-06	Ø 6,0mm; bayonet shaped		
243-810-03	RAY pituitary instrument; 3,0mm; 45° sideways	18,0cm; 7,2"	
243-818-02	HARDY pituitary instrument; 2,0mm	26,0cm; 10,4"	
243-823-22	NICOLA hypophysectomy instrument curette; flexible; left side cut.; Ø6,5mm	22,0cm; 8,8"	
243-824-22	NICOLA pituitary instrument	21,5cm; 8,6"	
243-825-22			

Weitere Artikel
further items
más artículos



Art.Nr.	Beschreibung Description	Size	Spez.
Other items available but not illustrated			
243-826-22	NICOLA pituitary instrument	21,5cm; 8,6"	
243-844-01	LANDOLT pituitary instrument	26,0cm; 10,4"	
243-844-02	malleable; blunt; right		
243-845-26	malleable; blunt; right		
243-846-26	malleable		
243-847-26	malleable		
243-850-26	FAHLBUSCH pituitary instrument	26,0cm; 10,4"	
243-851-26	malleable		
	curette; malleable; Ø 2,5mm		
243-854-26	HOSOBUCHI pituitary instrument	26,0cm; 10,4"	
243-857-22	LANDOLT-REULEN pituitary instrument	26,0cm; 10,4"	
243-857-32	raspatory; rigid; Ø 2,2mm		
243-859-25	raspatory; rigid; Ø 3,2mm		
243-861-17	curette; rigid; Ø 2,5mm		
243-862-20	hook; rigid; blunt; Ø 1,7mm		
	2,0mm		
243-864-23	micro dissector; bayonet shaped; upwards curved	23,0cm; 9,2"	
243-870-03	HARDY pituitary curette	24,0cm; 9,6"	
243-870-05	bayonet shaped; straight; angled up; Ø 3,0mm		
243-871-03	bayonet shaped; straight; angled up; Ø 5,0mm		
243-871-05	bayonet shaped; straight; angled down; Ø 3,0mm		
243-871-05	bayonet shaped; straight; angled down; Ø 5,0mm		
243-873-03	bayonet shaped; straight; 90° left; Ø 3,0mm		
243-873-05	bayonet shaped; straight; 90° left; Ø 5,0mm		
243-875-03	bayonet shaped; straight; 45° right; Ø 3,0mm		
243-875-05	bayonet shaped; straight; 45° right; Ø 5,0mm		

244

Weitere Artikel
 further items
 más artículos

Art.Nr.	Beschreibung Description	Size	Spez.
Other items available but not illustrated			
	applying forceps		
244-140-01	for small clips	16,0cm; 6,4"	
244-140-02	for medium clips	16,0cm; 6,4"	
244-141-01	for medium-large clips	19,0cm; 7,6"	
244-142-01	for small clips	20,0cm; 8"	
244-142-02	for medium clips	20,0cm; 8"	
244-142-03	for large clip	20,0cm; 8"	
	Mc KENZIE clip applying forcep; straight		
244-160-15	15,0cm; 6"		
244-160-19	19,0cm; 7,6"		
	YASARGIL applying forceps; bayonet shaped for vessel clips; rotatable, jaws in titan		
244-603-23T			
244-613-23T			

Alphabetisches Verzeichnis

A	
Anlegezange, YASARGIL.....	244.75- 244.77
AUSTIN, Mikro-Knüpfpinzette.....	243.38
B	
BADGLEY, Wundspreizer.....	243.31
C	
CASPAR, Drehschlüssel.....	243.19, 243.20
CASPAR, Explorationshaken.....	243.41
CASPAR, Haken.....	243.19, 243.20
CASPAR, Hypophysektomie-Kürette.....	243.45
CASPAR, Spekula.....	243.26, 243.27
CASPAR, Valve.....	243.19, 243.21- 243.28
CASPAR, Wundspreizer.....	243.19, 243.22, 243.24, 243.25, 243.27
CLOWARD, Valve.....	243.32, 243.33
CLOWARD, Wirbelkörperspreizer.....	243.34
CLOWARD, Wundspreizer.....	243.32, 243.33
CONE, Schädelstanzzange.....	243.4
CRUTCHFIELD, Schädelhalter.....	243.5
CRUTCHFIELD, Vorbohrer.....	243.5
CUSHING, Durahaken.....	243.15
CUSHING, Hirnspatel.....	243.12
D	
DAHLGREEN, Ersatzklinge.....	243.4
DAHLGREEN, Schädelstanze.....	243.4
DAVIS, Gefäßspatel.....	243.17
DE MARTEL, Einführungsinstrument.....	243.2
DE VILBISS, Ersatzklinge.....	243.3
DE VILBISS, Schädelstanze.....	243.3
Dissektor, Dura-.....	243.17
Dissektor, Dura-, FRAZIER.....	243.16
Dissektor, Dura-, MILLIGAN.....	243.17
Dissektor, Dura-, OLIVECRONA.....	243.16
Dissektor, Dura-, PENFIELD.....	243.18
Dissektor, Dura-, SACHS.....	243.16
Dissektor, Mikro-Instrument.....	243.40
Drahtsäge, OLIVECRONA.....	243.2
Drehschlüssel, CASPAR.....	243.19, 243.20
Duradissektor.....	243.17
Duradissektor, FRAZIER.....	243.16
Duradissektor, MILLIGAN.....	243.17
Duradissektor, OLIVECRONA.....	243.16
Duradissektor, PENFIELD.....	243.18
Duradissektor, SACHS.....	243.16
Durahaken, CUSHING.....	243.15
E	
Ersatzklinge, DAHLGREEN.....	243.4
Ersatzklinge, DE VILBISS.....	243.3
Explorationshaken, CASPAR.....	243.41
F	
Fadenführer, YASARGIL.....	243.44
Fixiervorrichtung, LEYLA.....	243.7, 243.10
FRAZIER, Duradissektor.....	243.16
G	
Galea Haken, YASARGIL.....	244.51
Gefäßspatel, DAVIS.....	243.17
Gefäßspatel, TOENNIS.....	243.17
Gewebekralle.....	243.44
GIGLI, Hakengriff.....	243.2
Griff, Haken-, GIGLI.....	243.2
H	
Haken, CASPAR.....	243.19, 243.20
Haken, Dura-, CUSHING.....	243.15
Haken, Explorations-, CASPAR.....	243.41
Haken, Galea, YASARGIL.....	244.51
Haken, Nerv-, SMITHWICK.....	243.15
Haken, Nervwurzel-, HOLSHER.....	243.13
Haken, Nervwurzel-, HORSLEY.....	243.13
Haken, Nervwurzel-, LOVE.....	243.14
Haken, Nervwurzel-, SACHS.....	243.13
Haken, Nervwurzel-, SCOVILLE.....	243.13
Haken, SCOVILLE.....	243.29, 243.30
Hakengriff, GIGLI.....	243.2
Haltearm, LEYLA.....	243.8, 243.9
HARDY, Hypophysektomie-Instrument.....	243.47
HARDY, Kürette.....	243.46
HARDY-FAHLBUSCH, Hypophysektomie-Instrument.....	243.47
HEIFETZ, Hirnspatel.....	243.11
HEIFETZ, Tumorfaßpinzette.....	243.36
Hirnretraktor, LEYLA.....	243.7- 243.9
Hirnspatel.....	243.12
Hirnspatel, CUSHING.....	243.12
Hirnspatel, HEIFETZ.....	243.11
Hirnspatel, OLIVECRONA.....	243.11, 243.12
HOLSHER, Nervwurzelhaken.....	243.13
HORSLEY, Nervwurzelhaken.....	243.13
Hypophysektomie-Instrument, HARDY.....	243.47
Hypophysektomie-Instrument, HARDY-FAHLBUSCH.....	243.47
Hypophysektomie-Kürette, CASPAR.....	243.45
Hypothesen-Zange, YASARGIL.....	243.45
I	
INGE, Wirbelkörperspreizer.....	243.34, 243.35
J	
JACOBSON, Mikro-Instrument.....	243.44
K	
Klammeranlegezange, MC KENZIE.....	244.48
Klammeranlegezange, OLIVECRONA-TOENNIS.....	244.48
Klinge, Ersatz-, DAHLGREEN.....	243.4
Klinge, Ersatz-, DE VILBISS.....	243.3



Alphabetisches Verzeichnis

Knüpfpinzette, Mikro 243.37- 243.39
KOOS, Mikro-Instrument 243.43

Kopfhautklammerzange, RANEY 244.48
Kugelgelenkkolben, LEYLA 243.8, 243.9
Kupplungskopf, LEYLA 243.8, 243.9
Kürette, HARDY 243.46
Kürette, Hypophysektomie-, CASPAR 243.45
Kürette, Mikro-Instrument, RAY 243.46

L
LAZAR, Mikro-Knüpfpinzette 243.39
LEYLA, Fixiervorrichtung 243.7, 243.10
LEYLA, Haltearm 243.8, 243.9
LEYLA, Hirnretraktor 243.7- 243.9
LEYLA, Kugelgelenkkolben 243.8, 243.9
LEYLA, Kupplungskopf 243.8, 243.9
LEYLA, Spannarm 243.7- 243.10
LEYLA, Spatelhalter 243.7- 243.10
LOVE, Nervwurzelhaken 243.14

M
MC KENZIE, Klammeranlagezange 244.48
MC KENZIE, Klammerblock 244.49
Mikro-Instrument Kürette, RAY 243.46
Mikro-Instrument, Dissektor 243.40
Mikro-Instrument, Häckchen 243.40
Mikro-Instrument, JACOBSON 243.44
Mikro-Instrument, KOOS 243.43
Mikro-Instrument, Löffel 243.40
Mikro-Instrument, Raspatorium 243.40
Mikro-Instrument, YASARGIL 243.42, 243.43
Mikro-Knüpfpinzette 243.37- 243.39
Mikro-Knüpfpinzette, AUSTIN 243.38
Mikro-Knüpfpinzette, LAZAR 243.39
Mikro-Knüpfpinzette, VISE 243.38
Mikro-Pinzette 243.37
Mikro-Pinzette, YASARGIL 243.35
MILLIGAN, Duradissektor 243.17

N
Nervhaken, SMITHWICK 243.15
Nervwurzelhaken, HOLSHER 243.13
Nervwurzelhaken, HORSLEY 243.13
Nervwurzelhaken, LOVE 243.14
Nervwurzelhaken, SACHS 243.13
Nervwurzelhaken, SCOVILLE 243.13, 243.14

O
OLIVECRONA, Drahtsäge 243.2
OLIVECRONA, Duradissektor 243.16
OLIVECRONA, Hirnspatel 243.11, 243.12
OLIVECRONA-TOENNIS, Klammeranlagezange 244.48

P
PENFIELD, Duradissektor 243.18
Pinzette zum Valvenwechseln 243.24
Pinzette-, Mikro 243.37

R
RANEY, Kopfhautklammerzange 244.48
Raspatorium, Mikro-Instrument 243.40
RAY, Mikro-Instrument Kürette 243.46
Retraktor, Hirn-, LEYLA 243.7- 243.9

S
SACHS, Duradissektor 243.16
SACHS, Nervwurzelhaken 243.13
Säge, Draht-, OLIVECRONA 243.2
SAMII, Tumorfäßpinzette 243.36
Schädelhalter 243.6
Schädelhalter, CRUTCHFIELD 243.5
Schädelstanzzange, CONE 243.4
Schädelstanze, DAHLGREEN 243.4
Schädelstanze, DE VILBISS 243.3
SCOVILLE, Haken 243.29, 243.30
SCOVILLE, Nervwurzelhaken 243.13, 243.14
SCOVILLE, Valve 243.29- 243.31
SCOVILLE, Wundspreizer 243.29
SCOVILLE-HAVERFIELD, Wundspreizer 243.30
Silberklammern 244.49
SMITHWICK, Nervhaken 243.15
Spannarm, LEYLA 243.7- 243.10
Spatel, Gefäß-, DAVIS 243.17
Spatel, gefäß-, TOENNIS 243.17
Spatel, Hirn- 243.12
Spatel, Hirn-, CUSHING 243.12
Spatel, Hirn-, HEIFETZ 243.11
Spatel, Hirn-, OLIVECRONA 243.11, 243.12
Spatelhalter, LEYLA 243.7- 243.10
Spekula, CASPAR 243.26, 243.27
Spreizer, Wirbelkörper-, CLOWARD 243.34
Spreizer, Wirbelkörper-, INGE 243.35
Spreizer, Wund-, BADGLEY 243.31
Spreizer, Wund-, CASPAR 243.19, 243.22, 243.24, 243.25, 243.27
Spreizer, Wund-, CLOWARD 243.32, 243.33
Spreizer, Wund-, SCOVILLE 243.29
Spreizer, Wund-, SCOVILLE-HAVERFIELD 243.30
Stanze, Schädel-, DAHLGREEN 243.4
Stanze, Schädel-, DE VILBISS 243.3

T
TAYLOR, Valve 243.31
TOENNIS, Gefäßspatel 243.17
Tumorfäßpinzette, HEIFETZ 243.36
Tumorfäßpinzette, SAMII 243.36
Tumorfäßpinzette, YASARGIL 243.35, 243.36
Tumorfäßpinzette, YASARGIL-SAMII 243.35

Alphabetisches Verzeichnis

U

Umführungsinstrument, DE MARTEL.....243.2

V

Valve, CASPAR..... 243.19, 243.21- 243.28

Valve, CLOWARD243.32, 243.33

Valve, SCOVILLE.....243.29- 243.31

Valve, TAYLOR.....243.31

VISE, Mikro-Knüpfpinzette243.38, 243.39

Vorbohrer, CRUTCHFIELD.....243.5

W

Wirbelkörperspreizer, CLOWARD.....243.34

Wirbelkörperspreizer, INGE243.34, 243.35

Wundspreizer, BADGLEY243.31

Wundspreizer, CASPAR..243.19, 243.22, 243.24, 243.25, 243.27

Wundspreizer, CLOWARD243.32, 243.33

Wundspreizer, SCOVILLE.....243.29

Wundspreizer, SCOVILLE-HAVERFIELD243.30

Y

YASARGIL, Anlegezange..... 244.75- 244.77

YASARGIL, Fadenführer243.44

YASARGIL, Galea Haken.....244.51

YASARGIL, Hypothesen-Zange243.45

YASARGIL, Mikro-Instrument.....243.42, 243.43

YASARGIL, Mikro-Pinzette243.35

YASARGIL, Tumorfaßpinzette.....243.35, 243.36

YASARGIL-SAMII, Tumorfaßpinzette243.35

Z

Zange, Anlege-, YASARGIL..... 244.75- 244.77

Zange, Hypothesen-, YASARGIL243.45

Zange, Klammeranlege-, MC KENZIE.....244.48

Zange, Klammeranlege-, OLIVECRONA-TOENNIS244.48

Zange, Kopfhautklammer-, RANEY.....244.48

Zange, Schädelstanz-, CONE243.4



Index, alphabetical

A		
applying forceps, RANEY	244.48	
applying forceps, YASARGIL	244.75- 244.77	
AUSTIN, micro tying forceps	243.38	
B		
BADGLEY, wound spreader	243.31	
ball and socket joint, LEYLA	243.8, 243.9	
blade, CASPAR	243.19, 243.21- 243.28	
blade, CLOWARD	243.32, 243.33	
blade, SCOVILLE	243.29- 243.31	
blade, spare, DAHLGREEN	243.4	
blade, spare, DE VILBISS	243.3	
blade, TAYLOR	243.31	
brain retractor, LEYLA	243.7- 243.10	
brain spatula	243.12	
brain spatula, CUSHING	243.12	
brain spatula, HEIFETZ	243.11	
brain spatula, OLIVECRONA	243.11, 243.12	
C		
CASPAR, blade	243.19, 243.21- 243.28	
CASPAR, exploration hook	243.41	
CASPAR, hook	243.19, 243.20	
CASPAR, key	243.19, 243.20	
CASPAR, micro curette	243.45	
CASPAR, specula	243.26- 243.27	
CASPAR, wound spreader	243.19, 243.22, 243.24, 243.25, 243.27	
clip applying forceps, MC KENZIE	244.48	
clip applying forceps, OLIVERCRONA-TOENNIS	244.48	
CLOWARD, blade	243.32, 243.33	
CLOWARD, lamina spreader	243.34	
CLOWARD, wound spreader	243.32, 243.33	
conductor, DE MARTEL	243.2	
CONE, cranial punch rongeur	243.4	
coupling head, LEYLA	243.8, 243.9	
cranial punch rongeur, CONE	243.4	
cranial punch, DAHLGREEN	243.4	
cranial punch, DE VILBISS	243.3	
CRUTCHFIELD, drill point	243.5	
CRUTCHFIELD, skull traction tong	243.5	
curette, HARDY	243.46	
curette, micro, CASPAR	243.45	
curette, micro, RAY	243.46	
CUSHING, brain spatula	243.12	
CUSHING, dura hook	243.15	
D		
DAHLGREEN, cranial punch	243.4	
DAHLGREEN, spare blade	243.4	
DAVIS, vascular spatula	243.17	
DE MARTEL, conductor	243.2	
DE VILBISS, cranial punch	243.3	
DE VILBISS, spare blade	243.3	
dissector, dura	243.17	
dissector, dura, FRAZIER	243.16	
dissector, dura, MILLIGAN	243.17	
dissector, dura, OLIVECRONA	243.16	
dissector, dura, PENFIELD	243.18	
dissector, dura, SACHS	243.16	
dissector, micro instrument	243.40	
drill point, CRUTCHFIELD	243.5	
dura dissector	243.17	
dura dissector, FRAZIER	243.16	
dura dissector, MILLIGAN	243.17	
dura dissector, OLIVECRONA	243.16	
dura dissector, PENFIELD	243.18	
dura dissector, SACHS	243.16	
dura hook, CUSHING	243.15	
E		
exploration hook, CASPAR	243.41	
F		
fixation base, LEYLA	243.7, 243.7	
flexible arm, LEYLA	243.7- 243.10	
forceps for changing valves	243.24	
forceps, applying, YASARGIL	244.75- 244.77	
forceps, clip applying, MC KENZIE	244.48	
forceps, clip applying, OLIVECRONA-TOENNIS	244.48	
forceps, pituitary, YASARGIL	243.45	
FRAZIER, dura dissector	243.16	
G		
galea hook, YASARGIL	244.51	
GIGLI, hook handle	243.2	
H		
handle, hook, GIGLI	243.2	
HARDY, curette	243.46	
HARDY, pituitary instrument	243.47	
HARDY-FAHLBUSCH, pituitary instrument	243.47	
HEIFETZ, brain spatula	243.11	
HEIFETZ, tumor grasping forceps	243.36	
holding rod, LEYLA	243.8, 243.9	
HOLSHER, nerve root retractor	243.13	
hook handle, GIGLI	243.2	
hook, CASPAR	243.19, 243.20	
hook, dura, CUSHING	243.15	
hook, exploration, CASPAR	243.41	
hook, galea, YASARGIL	244.51	
hook, nerve, SMITHWICK	243.15	
hook, SCOVILLE	243.29, 243.30	
HORSLEY, nerve root retractor	243.13	
I		
INGE, lamina spreader	243.34, 243.35	

Index, alphabetical

J

JACOBSON, micro instrument.....243.44

K

key, CASPAR.....243.19, 243.20
KOOS, micro instruments243.43

L

lamina spreader, CLOWARD243.34
lamina spreader, INGE.....243.34, 243.35
LAZAR, micro tying forcps243.39
LEYLA, ball and socket join.....243.8, 243.9
LEYLA, brain retractor243.7- 243.9
LEYLA, coupling head243.8, 243.9
LEYLA, fixation base243.7, 243.10
LEYLA, flexible arm243.7- 243.10
LEYLA, holding rod243.8, 243.9
LEYLA, support243.7- 243.10
ligature guide and carrier, YASARGIL.....243.44
LOVE, nerve root retractor.....243.14

M

MC KENZIE, clip applying forceps244.48

micro curette, CASPAR243.45
micro curette, RAY243.46
micro forceps243.37
micro forceps, YASARGIL243.35
micro instrument, dissector.....243.40
micro instrument, hook243.40
micro instrument, JACOBSON.....243.44
micro instrument, KOOS243.43
micro instrument, periosteal elevator.....243.40
micro instrument, spoon243.40
micro instrument, YASARGIL243.42, 243.43
micro tying forcps243.37- 243.39
micro tying forcps, AUSTIN.....243.38
micro tying forcps, LAZAR243.39
micro tying forcps, VISE.....243.38, 243.39
MILLIGAN, dura dissector.....243.17

N

nerve hook, SMITHWICK243.15
nerve root retractor, HOLSHER.....243.13
nerve root retractor, HORSLEY243.13
nerve root retractor, LOVE.....243.14
nerve root retractor, SACHS.....243.13
nerve root retractor, SCOVILLE.....243.13, 243.14

O

OLIVECRONA, brain spatula.....243.11, 243.12
OLIVECRONA, dura dissector.....243.16
OLIVECRONA, wire saw.....243.2
OLIVECRONA-TOENNIS, clip applying forceps.....244.48

P

PENFIELD, dura dissector.....243.18
periosteal elvator, micro instrument243.40
pituitary forceps, YASARGIL243.45
pituitary instrument, HARDY243.47
pituitary instrument, HARDY-FAHLBUSCH243.47
punch, cranial, DAHLGREEN243.4
punch, cranial, DE VILBISS243.3

R

RANEY, applying forceps244.48

RAY, micro curette243.46
retractor, brain, LEYLA243.7- 243.9
retractor, nerve root, HORSLEY243.13
retractor, nerve root, LOVE.....243.14
retractor, nerve root, SACHS.....243.13
retractor, nerve root, SCOVILLE.....243.13, 243.14
rongeur, cranial punch, CONE.....243.4

S

SACHS, dura dissector243.16
SACHS, nerve root retractor243.13
SAMII, tumor grasping forcps243.36
saw, wire, OLIVECRONA.....243.2

SCOVILLE, blade.....243.29, 243.30
SCOVILLE, nerve root retractor.....243.13, 243.14
SCOVILLE, wound spreader243.29
SCOVILLE-HAVERFIELD, wound spreader.....243.30

skull traction tong.....243.6
skull traction tong, CRUTCHFIELD243.5
SMITHWICK, nerve hook243.15
spare blade, DAHLGREEN243.4
spare blade, DE VILBISS.....243.3
spare pin.....243.6
spatula, brain.....243.12
spatula, brain, CUSHING243.12
spatula, brain, HEIFETZ.....243.11
spatula, brain, OLIVECRONA.....243.11, 243.12
spatula, vascular, DAVIS.....243.17
spatula, vascular, TOENNIS243.17
specula, CASPAR.....243.26, 243.27
spreader, lamina, CLOWARD243.34
spreader, lamina, INGE.....243.34, 243.35
spreader, wound, BADGLEY243.31
spreader, wound, CASPAR.....243.19, 243.22, 243.24, 243.25,
.....243.27
spreader, wound, CLOWARD.....243.32, 243.33
spreader, wound, SCOVILLE.....243.29
spreader, wound, SCOVILLE-HAVERFIELD243.30
support, LEYLA243.7- 243.10



Index, alphabetical

T

TAYLOR, blade	243.31
tissue claw	243.44
TOENNIS, vascular spatula	243.17
tumor grasping forceps, HEIFETZ	243.36
tumor grasping forceps, SAMII	243.36
tumor grasping forceps, YASARGIL	243.35, 243.36
tumor grasping forceps, YASARGIL-SAMII	243.35

V

vascular spatula, DAVIS	243.17
vascular spatula, TOENNIS	243.17

WISE, micro tying forcps	243.38, 243.39
--------------------------------	----------------

W

wire saw, OLIVECRONA	243.2
wound spreader, BADGLEY	243.31
wound spreader, CASPAR	243.19, 243.22, 243.24, 243.25,
.....	243.27
wound spreader, CLOWARD	243.32, 243.33
wound spreader, SCOVILLE	243.29
wound spreader, SCOVILLE-HAVERFIELD	243.30

Y

YASARGIL, applying forceps	244.75- 244.77
YASARGIL, galea hook	244.51
YASARGIL, ligature guide and carrier	243.44
YASARGIL, micro forcps	243.35
YASARGIL, micro instrument	243.42, 243.43
YASARGIL, pituitary forceps	243.45
YASARGIL, tumor grasping forceps	243.35, 243.36
YASARGIL-SAMII, tumor grasping forceps	243.35

Indice, alfabético

A

acoplamiento, LEYLA.....243.8, 243.9
AUSTIN, micro-pinzas de ligadura243.38

B

BADGLEY, separador autoestático243.31
brazo, LEYLA.....243.7- 243.10

C

CASPAR, espéculo para la columna243.26, 243.27
CASPAR, gancho243.19, 243.20
CASPAR, gancho para exploración.....243.41
CASPAR, llave243.19, 243.20
CASPAR, micro cucharillas243.45
CASPAR, separador autoestático243.19, 243.22, 243.24,
.....243.25, 243.27
CASPAR, valva243.19, 243.21- 243.28
cerebral, espátula.....243.12

CLOWARD, separador autoestático243.32, 243.33
CLOWARD, separador cuerpos vertebrales243.34
CLOWARD, valva243.32, 243.33
CONE, pinza saca-bocados craneal243.4
CRUTCHFIELD, perforador243.5
CRUTCHFIELD, tractor craneal.....243.5
cucharillas, HARDY243.46
CUSHING, espátula cerebral.....243.12
CUSHING, gancho para duramadre.....243.15

D

DAHLGREEN, hoja de repuesto243.4
DAHLGREEN, pinza sacabocado craneal.....243.4
DAVIS, disecador para duramadre.....243.17
DE MARTEL, guía-sierra.....243.2
DE VILBISS, hoja de repuesto243.3
DE VILBISS, pinza sacabocado craneal243.3
disecador para duramadre243.17
disecador para duramadre, DAVIS243.17
disecador para duramadre, FRAZIER243.16
disecador para duramadre, MILLIGAN243.17
disecador para duramadre, OLIVECRONA243.16
disecador para duramadre, PENFIELD243.18
disecador para duramadre, SACHS.....243.16
disecador para duramadre, TOENNIS.....243.17
disecador, instrumento para microcirugia.....243.40

E

espéculo para la columna, CASPAR243.26, 243.27
espátula cerebral243.12
espátula cerebral, CUSHING.....243.12
espátula cerebral, HEIFETZ.....243.11
espátula cerebral, OLIVECRONA243.11, 243.12
espina de repuesto.....243.6

F

fijador, LEYLA.....243.7- 243.10

FRAZIER, disecador para duramadre243.16

G

galea gancho, YASARGIL.....244.51
gancho para duramadre, CUSHING.....243.15
gancho para exploración, CASPAR.....243.41
gancho para nervios, SMITHWICK243.15
gancho, CASPAR243.19, 243.20
gancho, SCOVILLE.....243.29, 243.30
garra para el tejido243.44
GIGLI, mango243.2

guía-ligadura, YASARGIL243.44
guía-sierra , DE MARTEL.....243.2

H

HARDY, cucharillas.....243.46
HARDY, instrumento para la hipf sectomia243.47
HARDY-FAHLBUSCH, instrumento para la hipf sectomia243.47
HEIFETZ, espátula cerebral.....243.11
HEIFETZ, pinza para agarrar tumores243.36
hoja de repuesto, DAHLGREEN243.4
hoja de repuesto, DE VILBISS.....243.3
HOLSHER, separador para la raíz nervio243.13
HORSLEY, separador para la raíz nervio.....243.13

I

INGE, separador cuerpos vertebrales243.34, 243.35
instrumento para la hipf sectomia, HARDY243.47
instrumento para la hipf sectomia, HARDY-FAHLBUSCH243.47
instrumento para microcirugia, chucharilla243.40
instrumento para microcirugia, disecador243.40
instrumento para microcirugia, gancho.....243.40
instrumento para microcirugia, JACOBSON243.44
instrumento para microcirugia, KOOS243.43
instrumento para microcirugia, legra.....243.40
instrumento para microcirugia, YASARGIL243.42, 243.43

J

JACOBSON, instrumento para microcirugia.....243.44

K

KOOS, instrumento para microcirugia243.43

L

LAZAR, micro-pinzas de ligadura243.39
legra, instrumento para microcirugia.....243.40
LEYLA, acoplamiento243.8, 243.9
LEYLA, brazo.....243.7- 243.10
LEYLA, fijador.....243.7- 243.10
LEYLA, porta-espátula243.7- 243.10
LEYLA, separador cerebro243.7- 243.9
LEYLA, zapato para la fijacion243.8, 243.9
llave, CASPAR243.19, 243.20



Indice, alfabético

LOVE, separador para la raíz nervio.....243.14

M

mango, GIGLI243.2
MC KENZIE, pinza para poner grapas244.48

micro cucharillas, CASPAR243.45
micro cucharillas, RAY.....243.46
micro pinza243.37
micro pinza, YASARGIL.....243.35
micro-pinzas de ligadura243.37- 243.39
micro-pinzas de ligadura, AUSTIN243.38
micro-pinzas de ligadura, LAZAR.....243.39
micro-pinzas de ligadura, VISE243.38, 243.39
MILLIGAN, disecador para duramadre243.17

O

OLIVECRONA, disecador para duramadre243.16
OLIVECRONA, espátula cerebral243.11, 243.12
OLIVECRONA, sierra de hilo243.2
OLIVECRONA-TOENNIS, pinza para poner grapas.....244.48

P

PENFIELD, disecador para duramadre243.18
perforador, CRUTCHFIELD243.5
pinza para agarrar tumores, HEIFETZ.....243.36
pinza para agarrar tumores, SAMII.....243.36
pinza para agarrar tumores, YASARGIL243.35, 243.36
pinza para agarrar tumores, YASARGIL-SAMII243.35
pinza para aplicar, YASARGIL244.75- 244.77
pinza para aplicar agrafes, RANEY244.48
pinza para el cambio de valves243.24
pinza para poner grapas, MC KENZIE.....244.48
pinza para poner grapas, OLIVECRONA-TOENNIS.....244.48
pinza sacabocado craneal, DAHLGREEN.....243.4
pinza sacabocado craneal, DE VILBISS243.3
pinza saca-bocados craneal, CONE.....243.4
pinza, YASARGIL.....243.45
porta-espátula, LEYLA243.7- 243.10

R

RANEY, pinza para aplicar agrafes.....244.48
RAY, micro cucharillas243.46

S

SACHS, disecador para duramadre.....243.16
SACHS, separador para la raíz nervio.....243.13
SAMII, pinza para agarrar tumores.....243.36
SCOVILLE, gancho.....243.29, 243.30
SCOVILLE, separador autoestático243.29
SCOVILLE, separador para la raíz de nervio.....243.13, 243.14
SCOVILLE, valva243.29- 243.31
SCOVILLE-HAVERFIELD, separador autoestático.....243.30

separador autoestático, BADGLEY243.31
separador autoestático, CASPAR243.19, 243.22- 243.25
separador autoestático, CLOWARD243.32, 243.33
separador autoestático, SCOVILLE243.29
separador autoestático, SCOVILLE-HAVERFIELD.....243.30
separador cerebro, LEYLA243.7- 243.9
separador cuerpos vertebrales, CLOWARD243.34
separador cuerpos vertebrales, INGE.....243.34, 243.35
separador para la raíz nervio, HOLSHER.....243.13
separador para la raíz nervio, HORSLEY243.13
separador para la raíz nervio, LOVE.....243.14
separador para la raíz nervio, SACHS.....243.13
separador para la raíz nervio, SCOVILLE.....243.13, 243.14
sierra de hilo, OLIVECRONA243.2
SMITHWICK gancho para nervios243.15

T

TAYLOR, valva243.31
TOENNIS, disecador para duramadre.....243.17
tractor craneal243.6
tractor craneal, CRUTCHFIELD.....243.5

V

valva, CASPAR243.19, 243.21- 243.28
valva, CLOWARD243.32, 243.33
valva, SCOVILLE243.29, 243.31
valva, TAYLOR.....243.31
VISE, micro-pinzas de ligadura243.38, 243.39

Y

YASARGIL, galea gancho.....244.51
YASARGIL, guía-ligadura243.44
YASARGIL, instrumento para microcirugia243.42, 243.43
YASARGIL, pinza.....243.45
YASARGIL, pinza para agarrar tumores243.35, 243.36
YASARGIL, pinza para aplicar244.75- 244.77
YASARGIL-SAMII, pinza para agarrar tumores.....243.35

Z

zapato para la fijacion, LEYLA243.8, 243.9