



Laparoscopy



## Über uns | *About us*

**GLH Enterprises, Inc. was established in 1992 as a consulting and service organization. Our founders have more than 60 years combined work experience in the medical field.**

**Our products come from the leading surgical instrument manufacturers located in the Medical Valley of Tuttlingen, Germany. Tuttlingen is known as "The Surgical Instrument Capitol of the World."**

**We combine both tradition and innovation in our pursuit of excellence. We have a history of working in close collaboration with leading surgeons to develop and refine surgical instruments.**

**Our products utilize the newest manufacturing methods and are built with the skilled hands and keen eyes of highly qualified craftsmen to produce instruments that meet or exceed our quality standards. We are proud to state that our instruments are "Made in Germany."**

**To ensure the highest level of quality, our products are subject to a number of regulations such as DIN/ISO 9001, ISO 13485 and the FDA Good Manufacturing Practices. These standards are applied to all stages of the design, development and manufacturing process.**

**Our goal is to deliver superior surgical instruments as well as professional and efficient repair solutions to our customers.**

# Index

I



Endoor  
Laparoscopy  
Instruments

8-17

II



LAP-Instruments  
and Clip Appliers

18-25

III

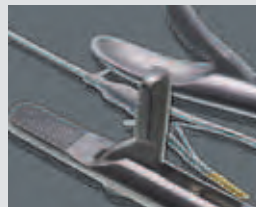

Needle holders  
Fascial closure  
device

26-31

IV



Retractors

32-33

VII



Trocars  
VERESS cannulas

48-63

**FL** Funktionslänge  
function length  
longitud de trabajo  
lunghezza Lavorativa

**→** Für den Einsatz in Schäften der Größe  
for use in sheath with size  
para el uso en las vainas del tamaño  
per l'uso con camicia di diametro

V



Suction-/Irrigation system

34-37

VI



HF-Instruments  
Monopolar and  
Bipolar

38-47

VIII



Telescopes  
Light guide cables

64-65

IX



Pediatric

66-67

X



Disposable

68-72

XI



Accessories

73-75



Technische Änderungen vorbehalten.  
We reserve the right to technical modifications.  
Nos reservamos el derecho de modificaciones técnicas.  
Ci riserviamo il diritto di modifiche tecniche.

# Enddoor

## 3-part designed laparoscopy instrument system

### Endoor general information

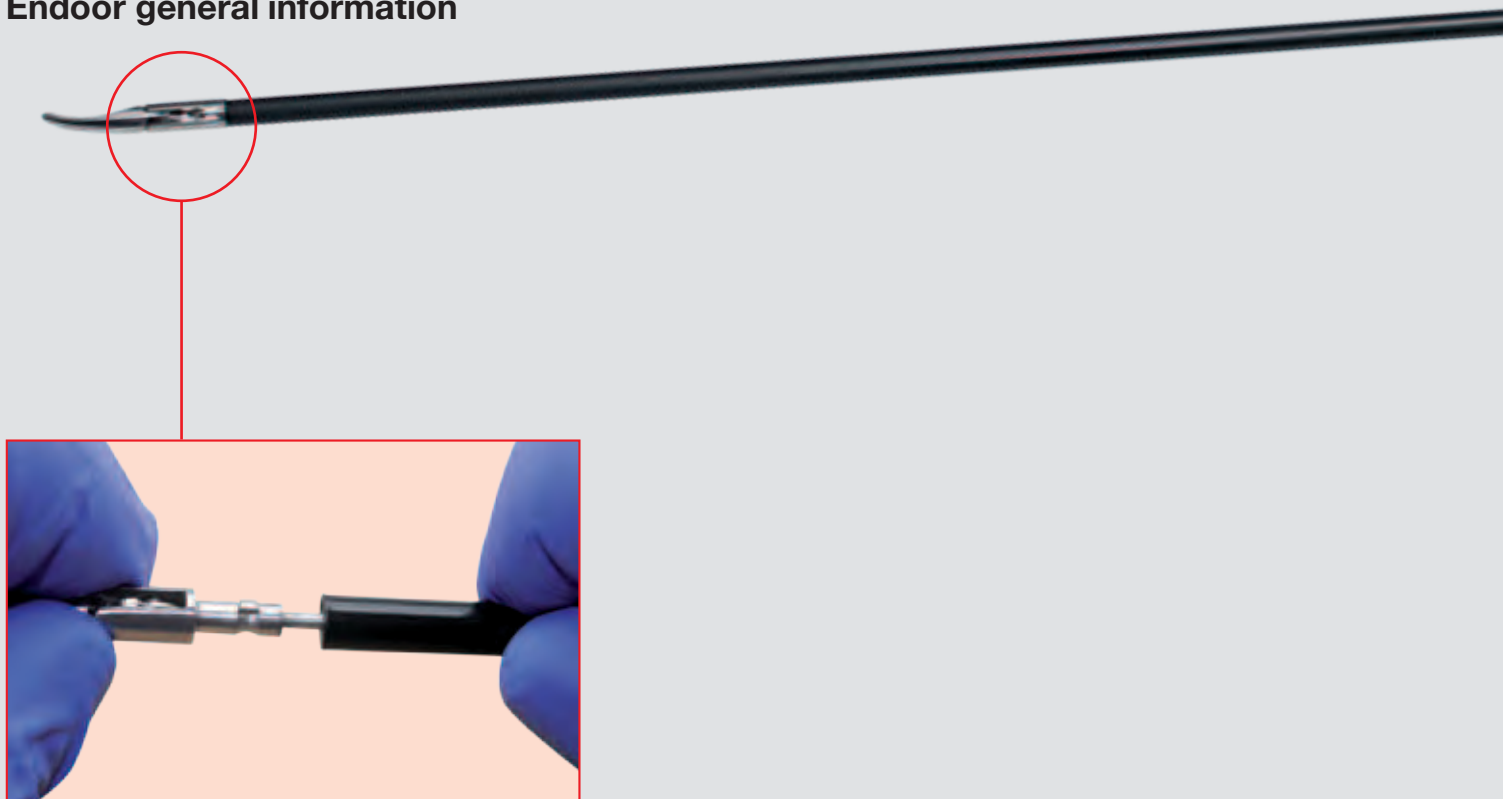

#### Technical Specifications:

- made of high-quality fiber-glass reinforced plastics
- the system is a monopolare three-part 360° rotatable demountable instrument
- easy and intuitive assembly and disassembly
- unique and mechanically safe connection system connection insert-sheath; bayonet connection shaft-handle; by extra drafted thread
- free from backlash mechanics for one-to-one tactile feedback
- the integrated ratchet can be easily activated or deactivated by rotating the selector
- ON/OFF ratchet
- shielded HF-connector
- accurate shaft coating with optimal insulation and superb sliding characteristics
- smooth-running ratchet design with elliptical tooth shape

#### Manufacturing:

- precision engineering standards and measurement
- the three-part design allows an easy maintenance and cleaning
- the instrument is designed for continuously variable rotation allowing highly precise manipulation
- special purple color design for easy locating
- fully autoclavable
- exclusively made in Germany

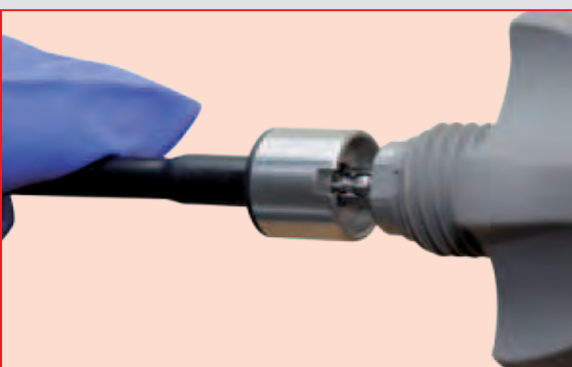
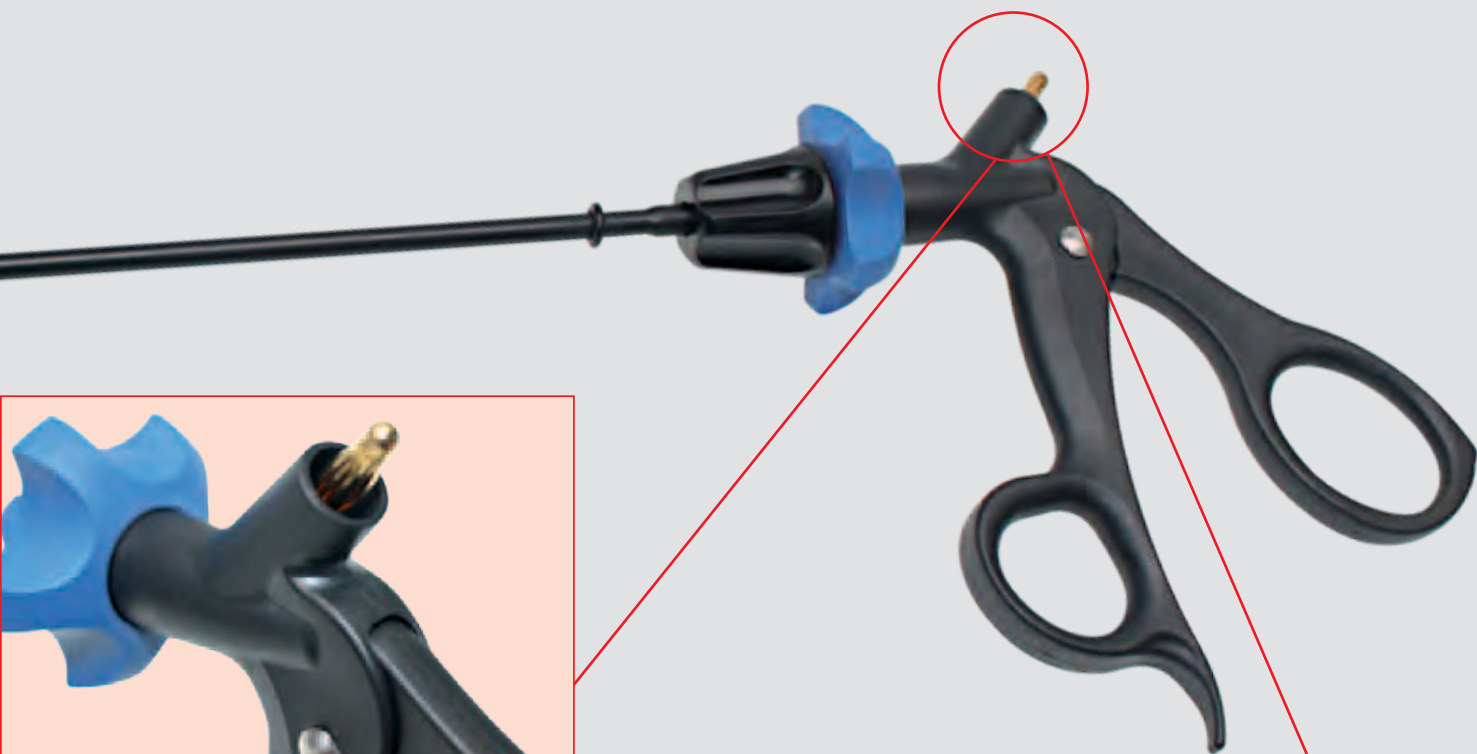

**Ergonomics:**

- improved ergonomic design, fits to all hand sizes
- ergonomic ring design for better grip and contact
- adjusting wheel specially designed for ergonomic positioning of jaw
- various ergonomic finger positions possible providing stress free surgery



**Endoor** laparoscopy instrument system

| Art.Nr. | Description | Size | Spez. |
|---------|-------------|------|-------|
|---------|-------------|------|-------|

|            |                                |  |  |
|------------|--------------------------------|--|--|
| 610-001-00 | Endoor handle; without ratchet |  |  |
|------------|--------------------------------|--|--|



|            |   |  |  |
|------------|---|--|--|
| 610-005-00 | Endoor handle; with ratchet<br>ratchet can be optionally activated or deactivated |  |  |
|------------|---|--|--|



|            |   |  |  |
|------------|---|--|--|
| 610-060-00 | Endoor rinsing adapter for handle; with cup nut;<br>with Luer Lock connection |  |  |
|------------|---|--|--|



rinsing adapter connected at the handle

monopolar cables see page 41

## Endoor laparoscopy instrument system

| Art.Nr.    | Description                         | Size                | Spez. |
|------------|-------------------------------------|---------------------|-------|
| 610-010-53 | Endoor shaft insulated with cup nut | Ø 5,0 mm; FL 330 mm |       |

|            |                                     |                     |  |
|------------|-------------------------------------|---------------------|--|
| 610-010-54 | Endoor shaft insulated with cup nut | Ø 5,0 mm; FL 420 mm |  |
|------------|-------------------------------------|---------------------|--|

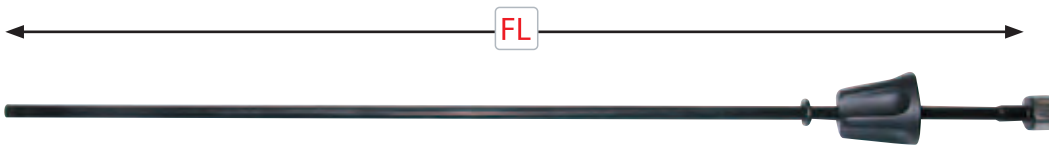

|            |                                     |                      |  |
|------------|-------------------------------------|----------------------|--|
| 610-020-93 | Endoor shaft insulated with cup nut | Ø 10,0 mm; FL 330 mm |  |
|------------|-------------------------------------|----------------------|--|

|            |                                     |                      |  |
|------------|-------------------------------------|----------------------|--|
| 610-020-94 | Endoor shaft insulated with cup nut | Ø 10,0 mm; FL 420 mm |  |
|------------|-------------------------------------|----------------------|--|

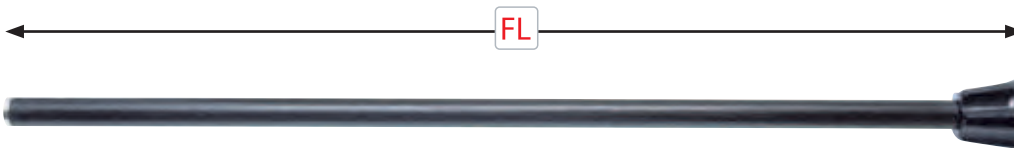

|            |  |  |  |
|------------|--|--|--|
| 610-050-00 | Endoor rinsing adapter for shaft;<br>with Luer Lock connection |  |  |
|------------|--|--|--|

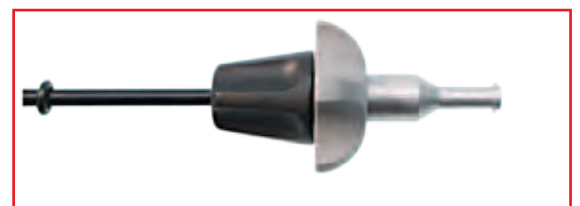









rinsing adapter connected at the shaft

Ø 3 mm Endoor laparoscopy instrument system see page 66

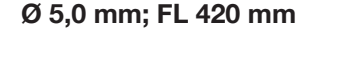



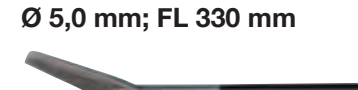
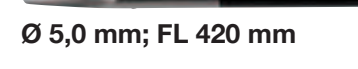





## Endoor laparoscopy instrument inserts Ø 5 mm

| Art.Nr.    | Description   | Size                | Spez.   |
|------------|---|---------------------|---|
| 610-100-53 | <b>METZENBAUM</b><br>standard scissors curved; double action jaw; serrated<br>→ shaft 610-010-53; handle 610-001-00     | Ø 5,0 mm; FL 330 mm |    |
| 610-110-53 | <b>METZENBAUM</b><br>scissors curved; double action jaw; serrated; blade 18 mm<br>→ shaft 610-010-53; handle 610-001-00 | Ø 5,0 mm; FL 330 mm |    |
| 610-110-54 | <b>METZENBAUM</b><br>scissors curved; double action jaw; serrated; blade 18 mm<br>→ shaft 610-010-54; handle 610-001-00 | Ø 5,0 mm; FL 420 mm |    |
| 610-111-53 | <b>METZENBAUM modified;</b><br>scissors curved; double action jaw; blade 18 mm<br>→ shaft 610-010-53; handle 610-001-00 | Ø 5,0 mm; FL 330 mm |  |
| 610-112-53 | <b>METZENBAUM</b><br>scissors straight; double action jaw; serrated<br>→ shaft 610-010-53; handle 610-001-00            | Ø 5,0 mm; FL 330 mm |  |
| 610-150-53 | <b>hook scissors; single action jaw</b><br>→ shaft 610-010-53; handle 610-001-00  | Ø 5,0 mm; FL 330 mm |  |
| 610-150-54 | <b>hook scissors; single action jaw</b><br>→ shaft 610-010-54; handle 610-001-00  | Ø 5,0 mm; FL 420 mm |  |
| 610-155-53 | <b>peritoneal scissors straight; single action jaw</b><br>→ shaft 610-010-53; handle 610-001-00                         | Ø 5,0 mm; FL 330 mm |  |
| 610-155-54 | <b>peritoneal scissors straight; single action jaw</b><br>shaft 610-010-54; handle 601-001-00                           | Ø 5,0 mm; FL 420 mm |  |

**Endoor** laparoscopy instrument inserts Ø 5 mm;  
grasping forceps; **double action**

| Art.Nr.         | Description  | Size                | Spez.   |
|-----------------|--|---------------------|---|
| 610-200-53<br>→ | <b>non-traumatic grasping forceps; pointed; double action jaw</b><br>shaft 610-010-53                  | Ø 5,0 mm; FL 330 mm |    |
| 610-200-54<br>→ | <b>non-traumatic grasping forceps; pointed; double action jaw</b><br>shaft 610-010-54                  | Ø 5,0 mm; FL 420 mm |   |
| 610-202-53<br>→ | <b>MARYLAND</b><br><b>dissecting and grasping forceps; double action jaw</b><br>shaft 610-010-53       | Ø 5,0 mm; FL 330 mm |    |
| 610-202-54<br>→ | <b>MARYLAND</b><br><b>dissecting and grasping forceps; double action jaw</b><br>shaft 610-010-54       | Ø 5,0 mm; FL 420 mm |   |
| 610-204-53<br>→ | <b>KELLY</b><br><b>dissecting and grasping forceps; tapered; double action jaw</b><br>shaft 610-010-53 | Ø 5,0 mm; FL 330 mm |  |
| 610-204-54<br>→ | <b>KELLY</b><br><b>dissection and grasping forceps; tapered; double action jaw</b><br>shaft 610-010-54 | Ø 5,0 mm; FL 420 mm |   |
| 610-205-53<br>→ | <b>MIXTER</b><br><b>grasping forceps; double action jaw; 90° angled</b><br>shaft 610-010-53            | Ø 5,0 mm; FL 330 mm |  |
| 610-206-53<br>→ | <b>MC KENAN</b><br><b>grasping forceps; double action jaw</b><br>shaft 610-010-53                      | Ø 5,0 mm; FL 330 mm |  |
| 610-207-53<br>→ | <b>Allis</b><br><b>grasping forceps; double action jaw; blade 38 mm</b><br>shaft 610-010-53            | Ø 5,0 mm; FL 330 mm |   |



**Endoor** laparoscopy instrument inserts Ø 5 mm;  
grasping forceps; **double action**







| Art.Nr.    | Description   | Size                | Spez.   |
|------------|---|---------------------|---|
| 610-210-53 | <b>dissecting and grasping forceps; fenestrated; double action jaw; blade 16 mm</b><br>→ shaft 610-010-53 | Ø 5,0 mm; FL 330 mm |    |
| 610-210-54 | <b>dissecting and grasping forceps; fenestrated; double action jaw; blade 16mm</b><br>→ shaft 610-010-54  | Ø 5,0 mm; FL 420 mm |   |
| 610-212-53 | <b>ENDO CLINCH grasping forceps; fenestrated; straight; double action jaw</b><br>→ shaft 610-010-53       | Ø 5,0 mm; FL 330 mm |    |
| 610-212-54 | <b>ENDO CLINCH grasping forceps; fenestrated; straight; double action jaw</b><br>→ shaft 610-010-54       | Ø 5,0 mm; FL 420 mm |   |
| 610-213-53 | <b>DOLPHIN dissecting and grasping forceps; double action jaw</b><br>→ shaft 610-010-53                   | Ø 5,0 mm; FL 330 mm |  |
| 610-214-53 | <b>grasping forceps with spoon; blunt; double action jaw</b><br>→ shaft 610-010-53                        | Ø 5,0 mm; FL 330 mm |  |
| 610-215-53 | <b>grasping forceps with spoon; pointed; double action jaw</b><br>→ shaft 610-010-53                      | Ø 5,0 mm; FL 330 mm |  |
| 610-300-53 | <b>BABCOCK non-traumatic grasping forceps; double action jaw</b><br>→ shaft 610-010-53                    | Ø 5,0 mm; FL 330 mm |  |
| 610-300-54 | <b>BABCOCK non-traumatic grasping forceps; double action jaw</b><br>→ shaft 610-010-54                    | Ø 5,0 mm; FL 420 mm |   |

**Endoor** laparoscopy instrument inserts Ø 5 mm;  
grasping forceps; **double action**

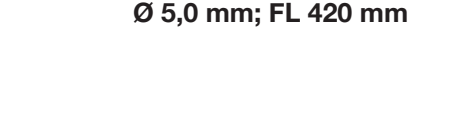

| Art.Nr.    | Description   | Size                | Spez.   |
|------------|---|---------------------|---|
| 610-216-53 | grasping forceps; wave style; double action jaw;<br>blade 24 mm<br>→ shaft 610-010-53                 | Ø 5,0 mm; FL 330 mm |    |
| 610-216-54 | grasping forceps; wave style; double action jaw;<br>blade 24 mm<br>→ shaft 610-010-54                 | Ø 5,0 mm; FL 420 mm |   |
| 610-218-53 | <b>JOHAN</b><br>grasping forceps; fenestrated; double action jaw<br>blade 25 mm<br>→ shaft 610-010-53 | Ø 5,0 mm; FL 330 mm |    |
| 610-220-53 | <b>DE BAKEY</b><br>grasping forceps; double action jaw;<br>blade 40 mm<br>→ shaft 610-010-53          | Ø 5,0 mm; FL 330 mm |  |
| 610-224-53 | <b>ALLIGATOR</b><br>grasping forceps; double action jaw<br>→ shaft 610-010-53                         | Ø 5,0 mm; FL 330 mm |  |
| 610-226-53 | <b>COBRA</b><br>grasping forceps; double action jaw<br>→ shaft 610-010-53                             | Ø 5,0 mm; FL 330 mm |  |
| 610-228-53 | grasping forceps; double action jaw<br>→ shaft 610-010-53   | Ø 5,0 mm; FL 330 mm |  |

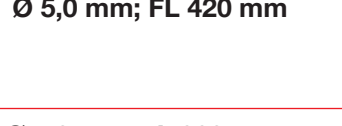

**Endoor** laparoscopy instrument inserts Ø 5 mm;  
grasping forceps; **single action**









| Art.Nr.    | Description  | Size                | Spez.   |
|------------|--|---------------------|---|
| 610-249-53 | <b>JOHAN</b><br>grasping forceps; up curved; double fenestrated;<br>single action jaw; blade 23 mm<br>→ shaft 610-010-53 | Ø 5,0 mm; FL 330 mm |    |
| 610-250-53 | <b>JOHAN</b><br>grasping forceps; fenestrated; single action jaw;<br>blade 25 mm<br>→ shaft 610-010-53                   | Ø 5,0 mm; FL 330 mm |    |
| 610-250-54 | <b>JOHAN</b><br>grasping forceps; fenestrated; single action jaw;<br>blade 25 mm<br>→ shaft 610-010-54                   | Ø 5,0 mm; FL 420 mm |   |
| 610-251-53 | <b>JOHAN</b><br>grasping forceps; fenestrated; single action jaw;<br>blade 38 mm<br>→ shaft 610-010-53                   | Ø 5,0 mm; FL 330 mm |   |
| 610-252-53 | <b>MAHNES</b><br>grasping forceps; fine teeth; single action jaw<br>→ shaft 610-010-53                                   | Ø 5,0 mm; FL 330 mm |  |
| 610-252-54 | <b>MAHNES</b><br>grasping forceps; fine teeth; single action jaw<br>→ shaft 610-010-54                                   | Ø 5,0 mm; FL 420 mm |  |
| 610-253-53 | grasping forceps; 1 x 2 teeth; single action jaw<br>→ shaft 610-010-53   | Ø 5,0 mm; FL 330 mm |  |
| 610-254-53 | grasping forceps; wave style; single action jaw;<br>blade 22 mm<br>→ shaft 610-010-53                                    | Ø 5,0 mm; FL 330 mm |  |

**Endoor** laparoscopy instrument inserts Ø 5 mm;  
grasping forceps; **single action**

| Art.Nr.    | Description   | Size                | Spez.   |
|------------|---|---------------------|---|
| 610-256-53 | <b>claw forceps; single action jaw;<br/>blade 22 mm</b><br>→ shaft 610-010-53               | Ø 5,0 mm; FL 330 mm |    |
| 610-258-53 | <b>dissector; strong curved; delicate serrated; single action jaw</b><br>→ shaft 610-010-53 | Ø 5,0 mm; FL 330 mm |    |
| 610-260-53 | <b>dissector; straight; single action jaw</b><br>→ shaft 610-010-53                         | Ø 5,0 mm; FL 330 mm |   |
| 610-350-53 | <b>biopsy forceps; with pin; single action jaw</b><br>→ shaft 610-010-53                    | Ø 5,0 mm; FL 330 mm |  |
| 610-350-54 | <b>biopsy forceps; with pin; single action jaw</b><br>→ shaft 610-010-54                    | Ø 5,0 mm; FL 420 mm |   |
| 610-352-53 | <b>biopsy punch; single action jaw</b><br>→ shaft 610-010-53                                | Ø 5,0 mm; FL 330 mm |  |
| 610-352-54 | <b>biopsy punch; single action jaw</b><br>→ shaft 610-010-54                                | Ø 5,0 mm; FL 420 mm |   |



**Endoor laparoscopy instrument inserts Ø 10 mm;  
single action**

| Art.Nr.    | Description  | Size                 | Spez.   |
|------------|--|----------------------|---|
| 610-400-93 | <b>claw forceps; single action jaw</b><br> shaft 610-020-93   | Ø 10,0 mm; FL 330 mm |    |
| 610-400-94 | <b>claw forceps; single action jaw</b><br> shaft 610-020-94   | Ø 10,0 mm; FL 420 mm |   |
| 610-406-93 | <b>spoon forceps; single action jaw</b><br> shaft 610-020-93  | Ø 10,0 mm; FL 330 mm |    |
| 610-406-94 | <b>spoon forceps; single action jaw</b><br> shaft 610-020-94 | Ø 10,0 mm; FL 420 mm |   |
| 610-410-93 | <b>OP scissors; single action jaw</b><br> shaft 610-020-93  | Ø 10,0 mm; FL 330 mm |  |

**Endoor** laparoscopy instrument inserts Ø 10 mm;  
grasping forceps; **double action**

| Art.Nr.    | Description  | Size                 | Spez. |
|------------|--|----------------------|-------|
| 610-425-93 | <b>MARYLAND</b><br>dissecting and grasping forceps; double action jaw<br>→ shaft 610-020-93                            | Ø 10,0 mm; FL 330 mm |       |
| 610-427-93 | <b>OVERHOLT</b><br>dissecting and grasping forceps; double action jaw<br>→ shaft 610-020-93                            | Ø 10,0 mm; FL 330 mm |       |
| 610-429-93 | <b>MIXTER</b><br>dissecting and grasping forceps; double action jaw; 90°<br>→ shaft 610-020-93                         | Ø 10,0 mm; FL 330 mm |       |
| 610-430-93 | <b>L-shape grasper;</b><br>dissecting and grasping forceps; cross serrated;<br>double action jaw<br>→ shaft 610-020-93 | Ø 10,0 mm; FL 330 mm |       |
| 610-435-93 | <b>BABCOCK</b><br>dissection and grasping forceps; double action jaw<br>→ shaft 610-020-93                             | Ø 10,0 mm; FL 330 mm |       |
| 610-439-93 | dissecting and grasping forceps; double action jaw<br>→ shaft 610-020-93   | Ø 10,0 mm; FL 330 mm |       |







**Laparoscopic instruments with wave ring handle;  
without ratchet**



with cleaning channel; with Luer Lock connector

| Art.Nr.    | Description   | Size                | Spez.   |
|------------|---|---------------------|---|
| 612-105-53 | grasping forceps; curved;<br>blade 22 mm                                  | Ø 5,0 mm; FL 330 mm |    |
| 612-110-53 | grasping forceps; non-traumatic   | Ø 5,0 mm; FL 330 mm |  |
| 612-115-53 | <b>MAHNES</b><br>grasping forceps   | Ø 5,0 mm; FL 330 mm |  |
| 612-120-53 | <b>DORSEY</b><br>grasping forceps; fenestrated;<br>blade 16 mm            | Ø 5,0 mm; FL 330 mm |  |
| 612-125-53 | <b>DORSEY modified</b><br>grasping forceps; fenestrated;<br>blade 12 mm   | Ø 5,0 mm; FL 330 mm |  |
| 612-130-53 | <b>DORSEY intestinal</b><br>grasping forceps; fenestrated;<br>blade 30 mm | Ø 5,0 mm; FL 330 mm |  |

Laparoscopic instruments **with wave ring handle;**  
**with ratchet**

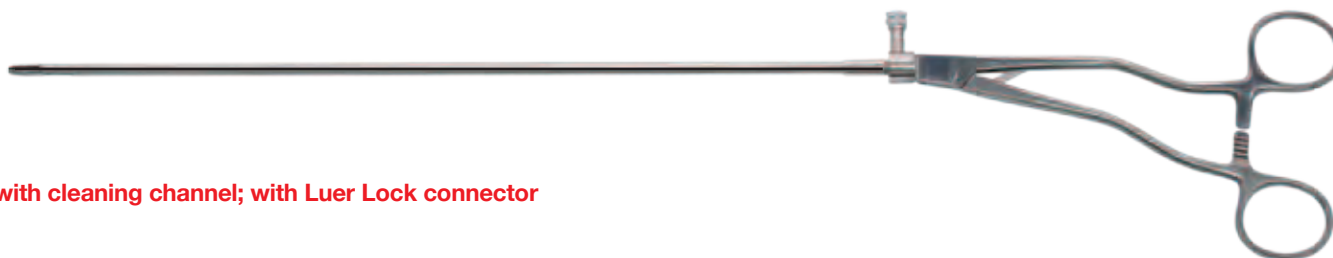

with cleaning channel; with Luer Lock connector

| Art.Nr.    | Description   | Size                | Spez.   |
|------------|---|---------------------|---|
| 612-205-53 | grasping forceps; curved;<br>blade 22 mm                                  | Ø 5,0 mm; FL 330 mm |    |
| 612-210-53 | grasping forceps; non-traumatic   | Ø 5,0 mm; FL 330 mm |  |
| 612-215-53 | <b>MAHNES</b><br>grasping forceps   | Ø 5,0 mm; FL 330 mm |  |
| 612-220-53 | <b>DORSEY</b><br>grasping forceps; fenestrated;<br>blade 16 mm            | Ø 5,0 mm; FL 330 mm |  |
| 612-225-53 | <b>DORSEY modified</b><br>grasping forceps; fenestrated;<br>blade 12 mm   | Ø 5,0 mm; FL 330 mm |  |
| 612-230-53 | <b>DORSEY intestinal</b><br>grasping forceps; fenestrated;<br>blade 30 mm | Ø 5,0 mm; FL 330 mm |  |



**Laparoscopy instruments with axial ring handle;  
without ratchet**

**with cleaning channel; with Luer Lock connector**



| Art.Nr.    | Description   | Size                | Spez.   |
|------------|---|---------------------|---|
| 612-305-53 | grasping forceps; curved;<br>blade 22 mm                                  | Ø 5,0 mm; FL 330 mm |    |
| 612-310-53 | grasping forceps; non-traumatic   | Ø 5,0 mm; FL 330 mm |  |
| 612-315-53 | <b>MAHNES</b><br>grasping forceps   | Ø 5,0 mm; FL 330 mm |  |
| 612-320-53 | <b>DORSEY</b><br>grasping forceps; fenestrated;<br>blade 16 mm            | Ø 5,0 mm; FL 330 mm |  |
| 612-325-53 | <b>DORSEY modified</b><br>grasping forceps; fenestrated;<br>blade 12 mm   | Ø 5,0 mm; FL 330 mm |  |
| 612-330-53 | <b>DORSEY intestinal</b><br>grasping forceps; fenestrated;<br>blade 30 mm | Ø 5,0 mm; FL 330 mm |  |

Laparoscopy instruments with axial ring handle;  
with ratchet



with cleaning channel; with Luer Lock connector

| Art.Nr.    | Description  | Size                | Spez.   |
|------------|--|---------------------|---|
| 612-405-53 | grasping forceps; curved;<br>blade 22 mm                           | Ø 5,0 mm; FL 330 mm |    |
| 612-410-53 | grasping forceps; non-traumatic                                    | Ø 5,0 mm; FL 330 mm |  |
| 612-415-53 | MAHNES<br>grasping forceps   | Ø 5,0 mm; FL 330 mm |  |
| 612-420-53 | Dorsey<br>grasping forceps; fenestrated;<br>blade 16 mm            | Ø 5,0 mm; FL 330 mm |  |
| 612-425-53 | Dorsey modified<br>grasping forceps; fenestrated;<br>blade 12 mm   | Ø 5,0 mm; FL 330 mm |  |
| 612-430-53 | Dorsey intestinal<br>grasping forceps; fenestrated;<br>blade 30 mm | Ø 5,0 mm; FL 330 mm |  |



## Laparoscopy instruments

| Art.Nr.    | Description   | Size                | Spez. |
|------------|---|---------------------|-------|
| 612-135-53 | <b>METZENBAUM modified;<br/>scissors curved; double action jaw; blade 18 mm</b> | Ø 5,0 mm; FL 330 mm |       |

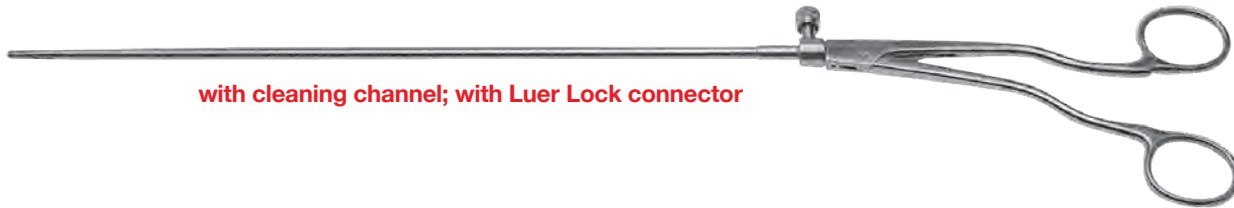

|            |   |                     |  |
|------------|---|---------------------|--|
| 612-990-53 | <b>cholangiography fixation forceps</b> | Ø 5,0 mm; FL 330 mm |  |
|------------|---|---------------------|--|

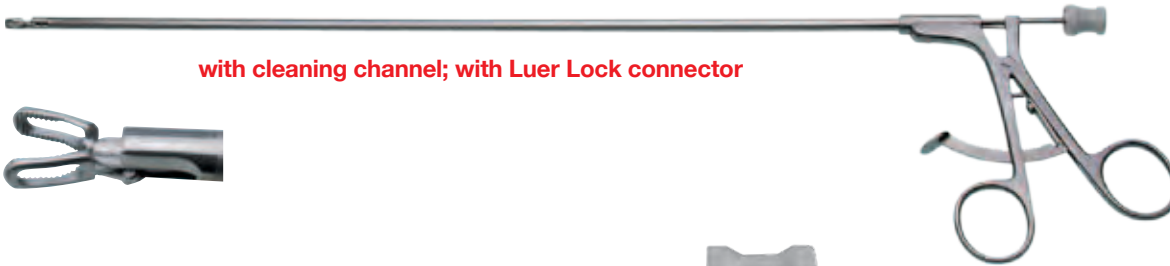

|            |   |         |  |
|------------|---|---------|--|
| 499-191-00 | <b>sealing cap for instrument channel</b> | 10 pcs. |  |
|------------|---|---------|--|



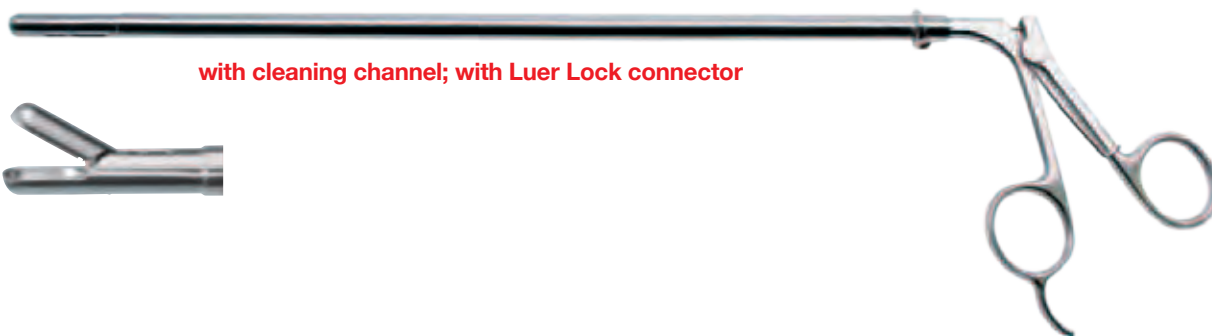

|            |  |                      |  |
|------------|--|----------------------|--|
| 612-540-93 | <b>spoon forceps with spring handle; single action jaw</b> | Ø 10,0 mm; FL 330 mm |  |
|------------|--|----------------------|--|

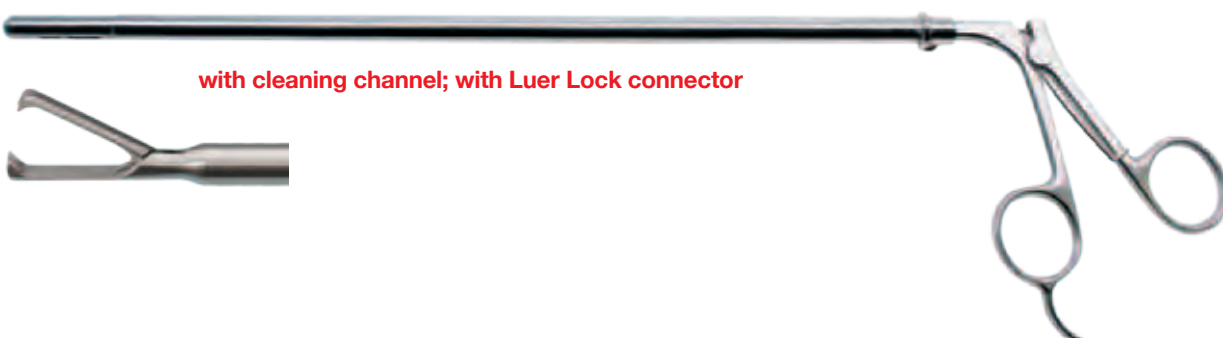

|            |   |                      |  |
|------------|---|----------------------|--|
| 612-550-93 | <b>claw forceps with spring handle; single action jaw</b> | Ø 10,0 mm; FL 330 mm |  |
|------------|---|----------------------|--|

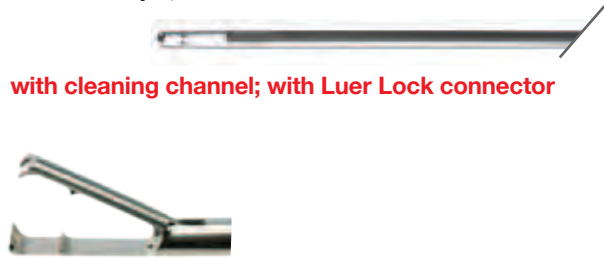
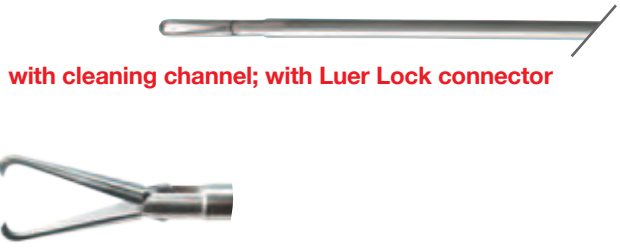

## Laparoscopy instruments

| Art.Nr.            | Description   | Size                 | Spez.                |
|--------------------|---|----------------------|----------------------|
| <b>Myoma Drill</b> |   |                      |                      |
|                    |   |                      |                      |
| 587-210-33         |   | Ø 10,0 mm; FL 330 mm |                      |
| 587-210-42         |   | Ø 10,0 mm; FL 420 mm |                      |
| 587-205-32         |   | Ø 5,0 mm; FL 330 mm  |                      |
| 587-205-42         |   | Ø 5,0 mm; FL 420 mm  |                      |
| 587-220-10         | <b>claw forceps; non-detachable</b><br><br><i>with cleaning channel; with Luer Lock connector</i>       |                      | Ø 10,0 mm; FL 420 mm |
| 587-225-10         | <b>tenaculum forceps; non-detachable</b><br><br><i>with cleaning channel; with Luer Lock connector</i> |                      | Ø 10,0 mm; FL 420 mm |
| 587-220-05         | <b>tenaculum forceps; non-detachable</b><br><br><i>with cleaning channel; with Luer Lock connector</i> |                      | Ø 5,0 mm; FL 420 mm  |



**Clip Appliers Ø 10 mm; ROTATABLE**



with cleaning channel; with Luer Lock connector

| Art.Nr.    | Description  | Spez.             | Size                 |
|------------|--------------|-------------------|----------------------|
| 612-920-01 | medium       | for Ethicon Clips | Ø 10,0 mm; FL 320 mm |
| 612-920-02 | medium-large | for Ethicon Clips | Ø 10,0 mm; FL 320 mm |
| 612-920-03 | large        | for Ethicon Clips | Ø 10,0 mm; FL 320 mm |

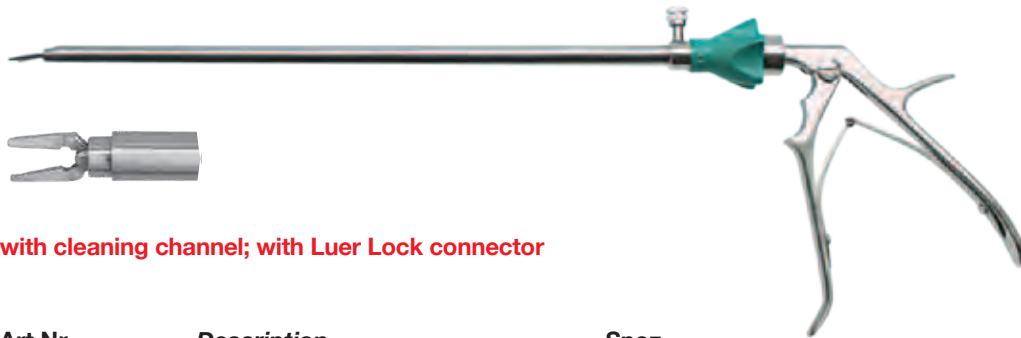

with cleaning channel; with Luer Lock connector

| Art.Nr.    | Description  | Spez.             | Size                 |
|------------|--------------|-------------------|----------------------|
| 612-930-00 | small        | for Ethicon Clips | Ø 10,0 mm; FL 320 mm |
| 612-930-01 | medium       | for Ethicon Clips | Ø 10,0 mm; FL 320 mm |
| 612-930-02 | medium-large | for Ethicon Clips | Ø 10,0 mm; FL 320 mm |
| 612-930-03 | large        | for Ethicon Clips | Ø 10,0 mm; FL 320 mm |
| 612-932-00 | small        | for Weck Clips    | Ø 10,0 mm; FL 320 mm |
| 612-932-01 | medium       | for Weck Clips    | Ø 10,0 mm; FL 320 mm |
| 612-932-02 | medium-large | for Weck Clips    | Ø 10,0 mm; FL 320 mm |
| 612-934-00 | small        | for SLS Clips     | Ø 10,0 mm; FL 320 mm |
| 612-934-01 | medium       | for SLS Clips     | Ø 10,0 mm; FL 320 mm |
| 612-934-02 | medium-large | for SLS Clips     | Ø 10,0 mm; FL 320 mm |
| 612-934-03 | large        | for SLS Clips     | Ø 10,0 mm; FL 320 mm |
| 612-936-00 | small        | for Horizon Clips | Ø 10,0 mm; FL 320 mm |
| 612-936-01 | medium       | for Horizon Clips | Ø 10,0 mm; FL 320 mm |
| 612-936-02 | medium-large | for Horizon Clips | Ø 10,0 mm; FL 320 mm |

## Clip Applicators Ø 10 mm; **ROTATABLE; DETACHABLE**



| Art.Nr.    | Description  | Spez.             | Size                 |
|------------|--------------|-------------------|----------------------|
| 612-910-00 | small        | for Ethicon Clips | Ø 10,0 mm; FL 320 mm |
| 612-910-01 | medium       | for Ethicon Clips | Ø 10,0 mm; FL 320 mm |
| 612-910-02 | medium-large | for Ethicon Clips | Ø 10,0 mm; FL 320 mm |
| 612-910-03 | large        | for Ethicon Clips | Ø 10,0 mm; FL 320 mm |
| 612-912-00 | small        | for Weck Clips    | Ø 10,0 mm; FL 320 mm |
| 612-912-01 | medium       | for Weck Clips    | Ø 10,0 mm; FL 320 mm |
| 612-912-02 | medium-large | for Weck Clips    | Ø 10,0 mm; FL 320 mm |
| 612-914-00 | small        | for SLS Clips     | Ø 10,0 mm; FL 320 mm |
| 612-914-01 | medium       | for SLS Clips     | Ø 10,0 mm; FL 320 mm |
| 612-914-02 | medium-large | for SLS Clips     | Ø 10,0 mm; FL 320 mm |
| 612-914-03 | large        | for SLS Clips     | Ø 10,0 mm; FL 320 mm |
| 612-916-00 | small        | for Horizon Clips | Ø 10,0 mm; FL 320 mm |
| 612-916-01 | medium       | for Horizon Clips | Ø 10,0 mm; FL 320 mm |
| 612-916-02 | medium-large | for Horizon Clips | Ø 10,0 mm; FL 320 mm |

## Clip Applicators Ø 5 mm; **ROTATABLE; DETACHABLE**



| Art.Nr.    | Description | Spez.             | Size                |
|------------|-------------|-------------------|---------------------|
| 612-940-00 | small       | for Ethicon Clips | Ø 5,0 mm; FL 320 mm |
| 612-940-01 | medium      | for Ethicon Clips | Ø 5,0 mm; FL 320 mm |
| 612-942-00 | small       | for Pilling Clips | Ø 5,0 mm; FL 320 mm |
| 612-942-01 | medium      | for Pilling Clips | Ø 5,0 mm; FL 320 mm |
| 612-944-00 | small       | for Weck Clips    | Ø 5,0 mm; FL 320 mm |
| 612-944-01 | medium      | for Weck Clips    | Ø 5,0 mm; FL 320 mm |
| 612-946-00 | small       | for Horizon Clips | Ø 5,0 mm; FL 320 mm |
| 612-946-01 | medium      | for Horizon Clips | Ø 5,0 mm; FL 320 mm |



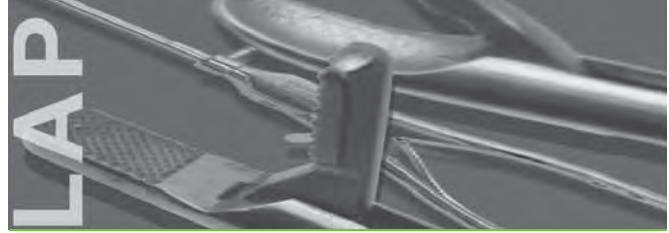





**Needle holders with ergonomic shank handle; with ratchet**

with cleaning channel; with Luer Lock connector



| Art.Nr.    | Description                    | Size                | Spez.   |
|------------|--------------------------------|---------------------|---|
| 614-005-53 | TC needle holder; straight     | Ø 5,0 mm; FL 330 mm |    |
| 614-005-54 | TC needle holder; straight     | Ø 5,0 mm; FL 450 mm |   |
| 614-010-53 | TC needle holder; curved left  | Ø 5,0 mm; FL 330 mm |  |
| 614-010-54 | TC needle holder; curved left  | Ø 5,0 mm; FL 450 mm |   |
| 614-015-53 | TC needle holder; curved right | Ø 5,0 mm; FL 330 mm |  |
| 614-020-53 | Needle holder; convex/concave  | Ø 5,0 mm; FL 330 mm |  |

"TC" means "tungsten carbide"

**Needle holders with axial ring handle;  
with ratchet**

with cleaning channel; with Luer Lock connector

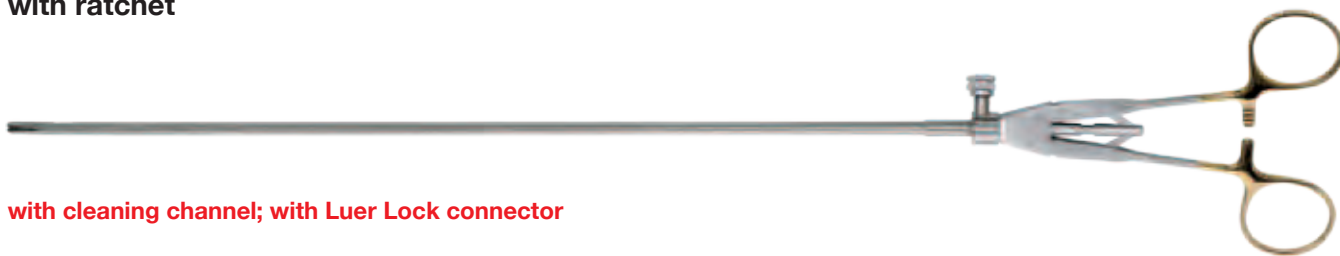

| Art.Nr.    | Description                       | Size                | Spez.   |
|------------|-----------------------------------|---------------------|---|
| 614-405-53 | TC needle holder; straight        | Ø 5,0 mm; FL 330 mm |    |
| 614-405-54 | TC needle holder; straight        | Ø 5,0 mm; FL 450 mm |    |
| 614-410-53 | TC needle holder; curved left     | Ø 5,0 mm; FL 330 mm |  |
| 614-410-54 | TC needle holder; curved left     | Ø 5,0 mm; FL 450 mm |  |
| 614-415-53 | TC needle holder; curved right    | Ø 5,0 mm; FL 330 mm |  |
| 614-420-53 | needle holder; convex/concave     | Ø 5,0 mm; FL 330 mm |  |
| 614-425-53 | TC needle holder; straight; short | Ø 5,0 mm; FL 330 mm |  |

"TC" means "tungsten carbide"

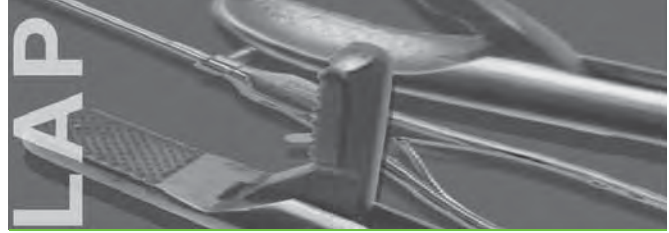

**Needle holders with axial wave-ring handle; with ratchet**





with cleaning channel; with Luer Lock connector



| Art.Nr.    | Description                                   | Size                | Spez.   |
|------------|---|---------------------|---|
| 614-205-53 | TC needle holder; straight; long              | Ø 5,0 mm; FL 330 mm |    |
| 614-205-54 | TC needle holder; straight; long              | Ø 5,0 mm; FL 450 mm |    |
| 614-210-53 | TC needle holder; curved left                 | Ø 5,0 mm; FL 330 mm |  |
| 614-210-54 | TC needle holder; curved left                 | Ø 5,0 mm; FL 450 mm |  |
| 614-215-53 | TC needle holder; curved right                | Ø 5,0 mm; FL 330 mm |  |
| 614-220-53 | needle holder; convex/concave                 | Ø 5,0 mm; FL 330 mm |  |
| 614-225-53 | TC needle holder; straight; short             | Ø 5,0 mm; FL 330 mm |  |
| 614-230-53 | TC needle holder; straight; opening angle 90° | Ø 5,0 mm; FL 330 mm |  |

"TC" means "tungsten carbide"

## Suture set

| Art.Nr.   | Description                             | Size                | Spez. |
|---|---|---------------------|-------|
| 618-100-43  | knot pusher with open eye               | Ø 4,0 mm; FL 330 mm |       |
|    |   |                     |       |
| 618-105-43  | knot pusher with closed eye             | Ø 4,0 mm; FL 330 mm |       |
|    |   |                     |       |
| 618-110-43  | knot pusher with slit                   | Ø 4,5 mm; FL 330 mm |       |
|  |   |                     |       |
| 618-180-53  | knot pusher with 4 pins                 | Ø 5,0 mm; FL 330 mm |       |
|  |   |                     |       |
| 626-182-95  | reducer sleeve (for Art.Nr. 618-180-53) | Ø 11,0 mm – 5,0 mm  |       |
|  |   |                     |       |

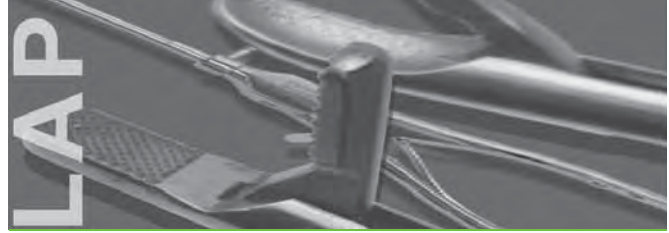

## Suture set

| Art.Nr.    | Description                      | Size                | Spez. |
|------------|----------------------------------|---------------------|-------|
| 612-295-53 | knot pusher grasper; fenestrated | Ø 5,0 mm; FL 330 mm |       |



with cleaning channel; with Luer Lock connector

|            |                          |                     |  |
|------------|--------------------------|---------------------|--|
| 612-195-53 | needle receiving forceps | Ø 5,0 mm; FL 330 mm |  |
|------------|--------------------------|---------------------|--|



with cleaning channel; with Luer Lock connector

## Fascia closure device ("FCD")

| Art.Nr.    | Description                   | Size                | Spez. |
|------------|-------------------------------|---------------------|-------|
| 618-195-20 | fascia closure device ("FCD") | Ø 2,3 mm; FL 140 mm |       |

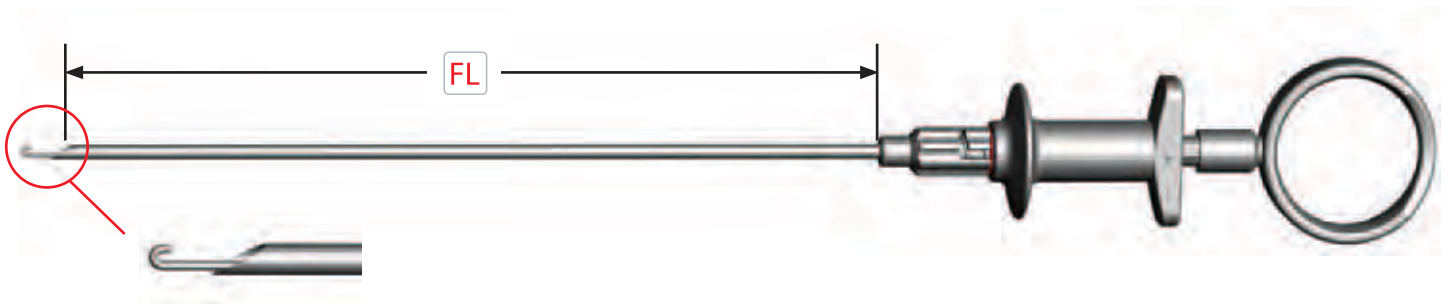

Push down the ring handle so that the needle is positioned outside the cannula. Set the thread into the "FCD" and make sure that the thread is positioned in the middle. Pull back the ring handle with your thumb so that the catcher hook is retracted into the cannula.



Penetrate the "FCD" through the subcutaneous tissue (using the incision of the trocar) in the abdominal wall. Make sure that the catcher hook is always retracted during this procedure.

After that, push down the ring handle so that the catcher hook comes out of the cannula.

Now you can release the thread. Then retract the catcher hook by pulling the ring handle and extract the "FCD".



Now penetrate the "FCD" on the other side of the trocar (picture 2). Please make sure again that the catcher hook is retracted during this procedure. When you have come through the subcutaneous tissue push down the ring handle so that the catcher hook comes out. Take the loose end of the thread by making use of the catcher-hook.

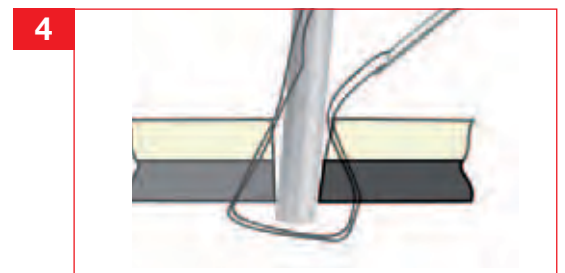

Pull the ring handle to retract the catcher hook again. Then remove the "fcd" with the thread followed by the extraction of the trocar sleeve.

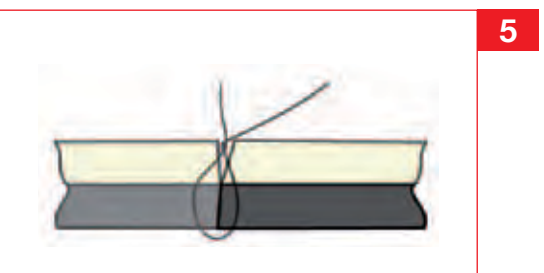

Knot the thread tightly in the subcutaneous tissue. This ensures an easy and safety handling of the abdominal wall closure.



## Endo-retractors with **CLEANING CHANNEL**

| Art.Nr.    | Description                                | Size                | Spez. |
|------------|--|---------------------|-------|
| 616-105-53 | retractor; bendable; 1 finger; fenestrated | Ø 5,0 mm; FL 340 mm |       |

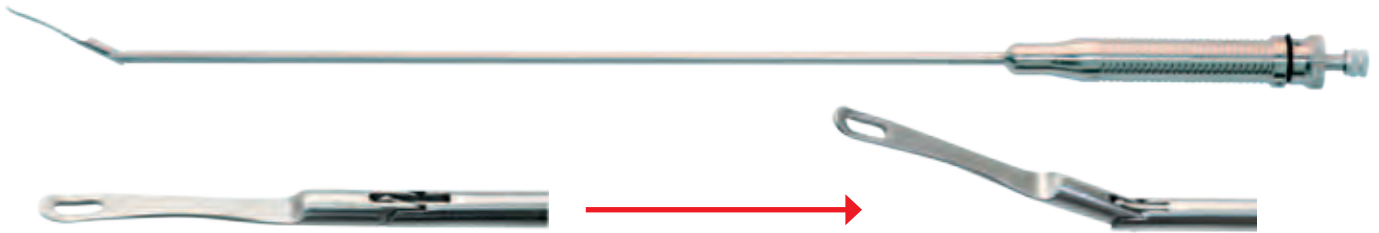

with cleaning channel; with Luer Lock connector

|            |                                |                     |  |
|------------|--------------------------------|---------------------|--|
| 616-110-53 | retractor; bendable; 3 fingers | Ø 5,0 mm; FL 340 mm |  |
|------------|--------------------------------|---------------------|--|



with cleaning channel; with Luer Lock connector

|            |                                |                      |  |
|------------|--------------------------------|----------------------|--|
| 616-120-93 | retractor; bendable; 5 fingers | Ø 10,0 mm; FL 380 mm |  |
|------------|--------------------------------|----------------------|--|



with cleaning channel; with Luer Lock connector

Endo-retractors; **DETACHABLE**

| Art.Nr.    | Description  | Size                | Spez. |
|------------|--|---------------------|-------|
| 616-205-53 | retractor; <b>detachable</b> ; bendable; 3 fingers | Ø 5,0 mm; FL 330 mm |       |



|            |  |                      |  |
|------------|--|----------------------|--|
| 616-220-53 | retractor; <b>detachable</b> ; bendable; 5 fingers | Ø 10,0 mm; FL 380 mm |  |
|------------|--|----------------------|--|





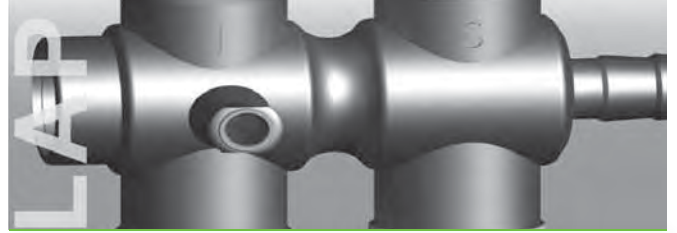





## Suction-/irrigation systems

| Art.Nr.    | Description   | Size                 | Spez. |
|------------|---|----------------------|-------|
| 620-010-00 | suction-/irrigation pistol handle style;<br>premium version; tube connectors;<br>with maximum suction flow Ø 5,2 mm |                      |       |
| 620-010-33 | suction-/irrigation tube  | Ø 3,0 mm; FL 330 mm  |       |
|            |   |                      |       |
| 620-010-53 | suction-/irrigation tube  | Ø 5,0 mm; FL 330 mm  |       |
|            |   |                      |       |
| 620-010-93 | suction-/irrigation tube  | Ø 10,0 mm; FL 330 mm |       |
|            |   |                      |       |
| 622-050-00 | adapter for HF-electrodes   |                      |       |

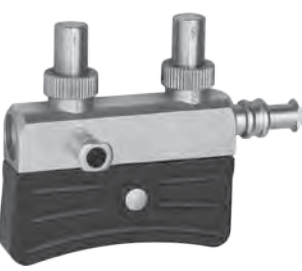
HF-electrodes see page 40

## Suction-/irrigation systems



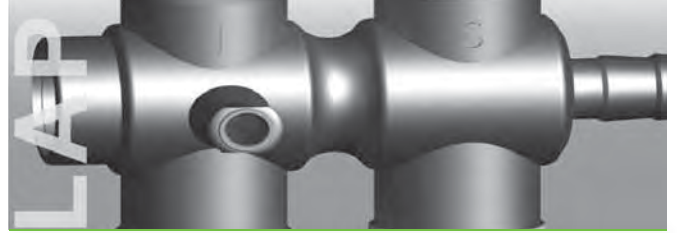



| Art.Nr.   | Description   | Size   | Spez. |
|---|---|--|-------|
| 620-015-00  | suction-/irrigation pistol handle style;<br>Luer Lock connectors;<br>with maximum suction flow Ø 4,4 mm |  |       |
|   |   |   |       |
| 620-015-09  | suction-/irrigation handle; Luer Lock connectors;<br>with maximum suction flow Ø 4,4 mm                 |  |       |
|   |   |  |       |
| 620-015-33  | suction-/irrigation tube  | Ø 3,0 mm; FL 330 mm  |       |
|  |   |  |       |
| 620-015-53  | suction-/irrigation tube  | Ø 5,0 mm; FL 330 mm  |       |
|  |   |  |       |
| 620-015-93  | suction-/irrigation tube  | Ø 10,0 mm; FL 330 mm   |       |
|  |   |  |       |

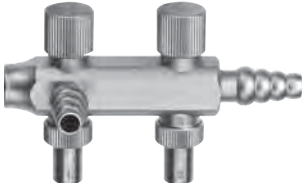

## Suction-/irrigation systems

| Art.Nr.    | Description   | Size                 | Spez. |
|------------|---|----------------------|-------|
| 620-020-00 | suction-/irrigation handles with trumpet valves;<br>Suction: large tube connector;<br>Irrigation: Luer Lock connector;<br>with maximum suction flow Ø 10,0 mm |                      |       |
| 620-020-10 | suction-/irrigation handle with trumpet valves;<br>Suction: small tube connector;<br>Irrigation: Luer Lock connector;<br>with maximum suction flow Ø 6,5 mm   |                      |       |
| 620-020-53 | suction-/irrigation tube  | Ø 5,0 mm; FL 330 mm  |       |
|            |   |                      |       |
| 620-020-93 | suction-/irrigation tube  | Ø 10,0 mm; FL 330 mm |       |
|            |   |                      |       |
| 620-030-00 | suction-/irrigation tube with Luer Lock stopcock  | Ø 5,0 mm; FL 330 mm  |       |
|            |   |                      |       |





## Suction-/irrigation systems

| Art.Nr.    | Description  | Size  | Spez.   |
|------------|--|---|---|
| 620-025-00 | suction-/irrigation handle with sliding valve;<br>tube connectors  |  |   |
| 620-025-09 | suction-/irrigation handle with trumpet valves;<br>tube connectors |  |   |
| 620-025-13 | suction-/irrigation tube; 16 holes (4 x 4)                         | Ø 5,0 mm; FL 330 mm   |  |
| 620-025-23 | suction-/irrigation tube; 48 holes (8 x 6)                         | Ø 5,0 mm; FL 330 mm   |  |
| 620-025-33 | suction-/irrigation tube; blunt; with holes (4 x 6)                | Ø 5,0 mm; FL 330 mm   |  |
| 620-025-43 | suction-/irrigation tube; needle                                   | Ø 5,0 mm; FL 330 mm   |  |
| 620-025-53 | suction-/irrigation tube; aqua dissection                          | Ø 5,0 mm; FL 330 mm   |  |
| 620-025-63 | suction-/irrigation tube; blunt; 12 holes                          | Ø 5,0 mm; FL 330 mm   |  |



**HF-laparoscopy electrodes;**  
**MONOPOLAR**







| Art.Nr.    | Description                  | Size                | Spez.   |
|------------|------------------------------|---------------------|---|
| 622-010-13 | button electrode; monopolar  | Ø 5,0 mm; FL 330 mm |    |
| 622-010-23 | J-hook electrode; monopolar  | Ø 5,0 mm; FL 330 mm |   |
| 622-010-33 | L-hook electrode; monopolar  | Ø 5,0 mm; FL 330 mm |  |
| 622-010-43 | spatula electrode; monopolar | Ø 5,0 mm; FL 330 mm |  |

monopolar cables see page 41

**HF-laparoscopy electrodes; with irrigation channel and trumpet valve;  
MONOPOLAR**



| Art.Nr.    | Description   | Size                | Spez.   |
|------------|---|---------------------|---|
| 622-030-13 | button electrode; monopolar;<br>trumpet valve and Luer Lock connector     | Ø 5,0 mm; FL 330 mm |    |
| 622-030-23 | J-hook electrode; monopolar;<br>trumpet valve and Luer Lock connector     | Ø 5,0 mm; FL 330 mm |    |
| 622-030-33 | L-hook electrode; monopolar;<br>trumpet valve and Luer Lock connector     | Ø 5,0 mm; FL 330 mm |  |
| 622-030-43 | spatula electrode; monopolar;<br>trumpet valve and Luer Lock connector    | Ø 5,0 mm; FL 330 mm |  |
| 622-030-53 | irrigation electrode; monopolar;<br>trumpet valve and Luer Lock connector | Ø 5,0 mm; FL 330 mm |  |

monopolar cables see page 41



Suction-/irrigation-HF-combination system;  
**MONOPOLAR**

| Art.Nr.    | Description   | Size   | Spez.   |
|------------|---|--|---|
| 620-010-00 | suction-/irrigation pistol handle style;<br>premium version; tube connector |   |   |
| 622-050-00 | adapter for HF-electrodes   |  |   |
| 622-050-13 | button electrodes   | Ø 5,0 mm; Fl 330 mm  |   |
| 622-050-23 | J-hook electrodes   | Ø 5,0 mm; Fl 330 mm  |   |
| 622-050-33 | I -hook electrodes  | Ø 5,0 mm; Fl 330 mm  |   |
| 622-050-43 | spatula electrodes  | Ø 5,0 mm; Fl 330 mm  |   |
| 622-050-53 | needle electrodes   | Ø 5,0 mm; Fl 330 mm  |  |

Suction-/irrigation tubes see page 34

HF-laparoscopy needle electrodes;  
**MONOPOLAR**

| Art.Nr.    | Description                    | Size                | Spez. |
|------------|--------------------------------|---------------------|-------|
| 622-040-03 | HF-needle electrode; monopolar | Ø 5,0 mm; FL 320 mm |       |

**Monopolar** cables







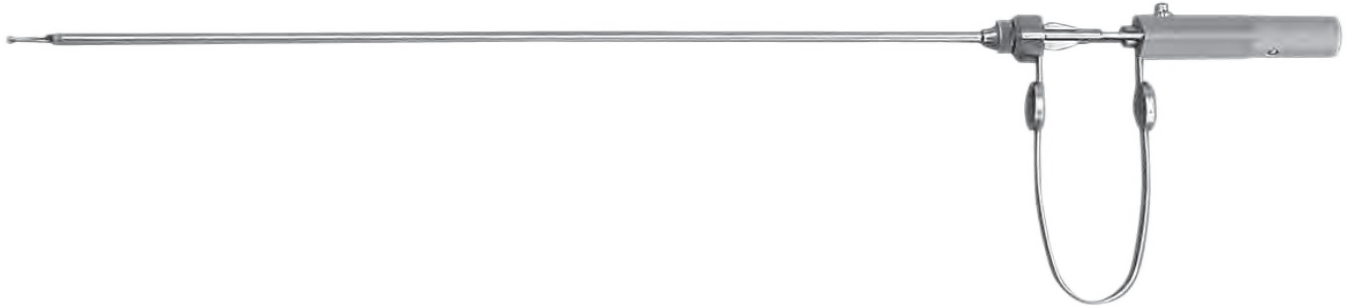

| Art.Nr.    | Description                                 | Instrument-side | Unit-side    |
|------------|---|-----------------|--------------|
| 287-815-30 | monopolar HF-cable for Martin units         | Ø 4,0 mm        | Ø 4,0 mm 3 m |
| 287-815-50 | monopolar HF-cable for Martin units         | Ø 4,0 mm        | Ø 4,0 mm 5 m |
| 287-825-30 | monopolar HF-cable for Valleylab units      | Ø 4,0 mm        | Ø 8,0 mm 3 m |
| 287-825-50 | monopolar HF-cable for Valleylab units      | Ø 4,0 mm        | Ø 8,0 mm 5 m |
| 287-820-30 | monopolar HF-cable for Erbe (ACC/ICC) units | Ø 4,0 mm        | Ø 5,0 mm 3 m |
| 287-820-50 | monopolar HF-cable for Erbe (ACC/ICC) units | Ø 4,0 mm        | Ø 5,0 mm 5 m |

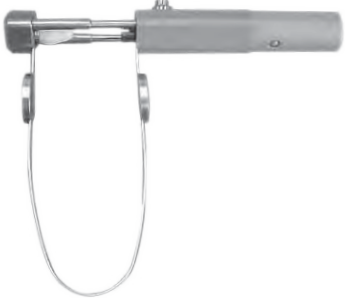









## BIPOLAR coagulation forceps



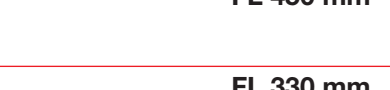















| Art.Nr.    | Description                                      | Size  | Spez.               |
|------------|--|---|---------------------|
| 628-101-00 | spring handle for bipolar coagulation forceps    |   |                     |
| 628-101-99 | sealing cap for electrode; 10 pcs./box           |    |                     |
| 628-105-00 | scissors handle; for bipolar coagulation forceps |  |                     |
| 628-101-99 | sealing cap for electrode; 10 pcs./box           |    |                     |
| 628-110-53 | plastic shaft; for bipolar coagulation forceps   |    | Ø 5,0 mm; FL 330 mm |
| 628-110-54 | plastic shaft; for bipolar coagulation forceps   |    | Ø 5,0 mm; FL 450 mm |
| 628-115-53 | shaft metal; for bipolar coagulation forceps     |    | Ø 5,0 mm; FL 330 mm |
| 628-115-54 | metal shaft; for bipolar coagulation forceps     |    | Ø 5,0 mm; FL 450 mm |

## BIPOLAR coagulation forceps electrodes









| Art.Nr.    | Description  | Size  | Spez.     |
|------------|--|---|-----------|
| 628-140-53 | <b>tong type bipolar insert; wide 3 mm</b><br>→ shafts 628-110-53 or 628-115-53<br><b>or</b>             |    | FL 330 mm |
| 628-140-54 | <b>tong type bipolar insert; wide 3 mm</b><br>→ shafts 628-110-54 or 628-115-54                          |    | FL 450 mm |
| 628-142-53 | <b>fluted bit 1 mm bipolar insert; short insulated</b><br>→ shafts 628-110-53 or 628-115-53<br><b>or</b> |    | FL 330 mm |
| 628-142-54 | <b>fluted bit 1 mm bipolar insert; short insulated</b><br>→ shafts 628-110-54 or 628-115-54              |    | FL 450 mm |
| 628-143-53 | <b>fluted bit 1 mm bipolar insert; long insulated</b><br>→ shafts 628-110-53 or 628-115-53<br><b>or</b>  |   | FL 330 mm |
| 628-143-54 | <b>fluted bit 1 mm bipolar insert; long insulated</b><br>→ shafts 628-110-54 or 628-115-54               |  | FL 450 mm |
| 628-144-53 | <b>grasping forceps; fenestrated</b><br>→ shafts 628-110-53 or 628-115-53<br><b>or</b>                   |  | FL 330 mm |
| 628-144-54 | <b>grasping forceps; fenestrated</b><br>→ shafts 628-110-54 or 628-115-54                                |  | FL 450 mm |

## Bipolar cables









| Art.Nr.    | Description                                | Instrument-side  | Unit-side   |               |
|------------|--|--|---|---------------|
| 287-200-30 | bipolar cable for Erbe units               |  |  | 3 m           |
| 287-200-50 | bipolar cable for Erbe units               |  |  | 5 m           |
| 287-205-30 | bipolar cable for Martin units             |  |  | 3 m           |
| 287-205-50 | bipolar cable for Martin units             |  |  | 5 m           |
| 287-210-30 | bipolar Banana plugs cable with 2 x Ø 4 mm |  |  | Ø 4,0 mm; 3 m |
| 287-210-50 | bipolar Banana plugs cable with 2 x Ø 4 mm |  |  | Ø 4,0 mm; 5 m |
| 287-215-30 | bipolar cable for Valleylab units          |  |  | Ø 4,0 mm; 3 m |
| 287-215-50 | bipolar cable for Valleylab units          |  |  | Ø 4,0 mm; 5 m |



## BIPOLAR coagulation forceps

| Art.Nr.    | Description   | Size   | Spez.   |
|------------|---|--|---|
| 628-201-53 | standard handle for bipolar coagulation forceps;<br>inclusive shaft | Ø 5,0 mm; FL 340 mm  |   |
| 628-205-53 | ring handle for bipolar coagulation forceps;<br>inclusive shaft     | Ø 5,0 mm; FL 340 mm  |   |
| Art.Nr.    | Description   | Instrument-side  | Unit-side   |
| 628-299-00 | adapter for bipolar cable with flat plug                            |  | cable page 43   |
| 628-292-03 | bipolar cable for Erbe units  |  | 3 m            |
| 628-293-03 | bipolar cable for Martin units                                      |  | 3 m            |
| 628-294-03 | bipolar Banana plugs cable with 2 x Ø 4 mm                          |  | Ø 4,0 mm; 3 m  |
| 628-295-03 | bipolar cable for Valleylab units                                   |  | Ø 4,0 mm; 3 m  |

## BIPOLAR coagulation forceps

| Art.Nr.    | Description   | Size                | Spez.   |
|------------|---|---------------------|---|
| 628-240-53 | tong type;<br>bipolar insert; wide 3,0 mm                     | for Ø 5,0 mm        |    |
| 628-242-53 | fluted bit 1 mm;<br>bipolar insert                            | for Ø 5,0 mm        |    |
| 628-244-53 | grasping forceps;<br>bipolar; fenestrated                     | for Ø 5,0 mm        |    |
| 628-246-53 | <b>MARYLAND</b><br>bipolar insert; curved                     | for Ø 5,0 mm        |  |
| 628-248-53 | <b>KLEPPINGER</b><br>bipolar insert; serrated                 | for Ø 5,0 mm        |  |
| 628-250-53 | <b>METZENBAUM</b><br>bipolar insert; scissors curved          | for Ø 5,0 mm        |  |
| 628-252-53 | <b>METZENBAUM</b><br>bipolar insert; scissors TC blade curved | for Ø 5,0 mm        |  |
| 628-202-53 | outer shaft   | Ø 5,0 mm; FL 340 mm |   |









## BIPOLAR coagulation forceps power T-style

| Art.Nr.    | Description   | Size                | Spez. |
|------------|---|---------------------|-------|
| 628-301-53 | T-style handle for bipolar coagulation forceps; inclusive shaft | Ø 5,0 mm; FL 340 mm |       |



|            |   |                     |  |
|------------|---|---------------------|--|
| 628-305-53 | T-style turnable for bipolar coagulation forceps; inclusive shaft | Ø 5,0 mm; FL 340 mm |  |
|------------|---|---------------------|--|



| Art.Nr.    | Description                                | Instrument-side  | Unit-side   |
|------------|--|--|---|
| 287-200-30 | bipolar cable for Erbe units               |  |  3 m           |
| 287-205-30 | bipolar cable for Martin units             |  |  3 m           |
| 287-210-30 | bipolar Banana plugs cable with 2 x Ø 4 mm |  |  Ø 4,0 mm; 3 m |
| 287-215-30 | bipolar cable for Valleylab units          |  |  Ø 4,0 mm; 3 m |

## BIPOLAR coagulation inserts for power T-style

| Art.Nr.    | Description  | Size                | Spez. |
|------------|--|---------------------|-------|
| 628-341-53 | micro grasper;<br>bipolar; fenestrated insert        | for Ø 5,0 mm        |       |
| 628-342-53 | grasping forceps;<br>bipolar; delicate curved insert | for Ø 5,0 mm        |       |
| 628-343-53 | grasping forceps;<br>bipolar; curved insert          | for Ø 5,0 mm        |       |
| 628-344-53 | grasping forceps;<br>bipolar; fenestrated insert     | for Ø 5,0 mm        |       |
| 628-346-53 | MARYLAND<br>bipolar insert                           | for Ø 5,0 mm        |       |
| 628-350-53 | METZENBAUM<br>bipolar insert; scissors curved        | for Ø 5,0 mm        |       |
| 628-302-53 | outer shaft  | Ø 5,0 mm; FL 340 mm |       |



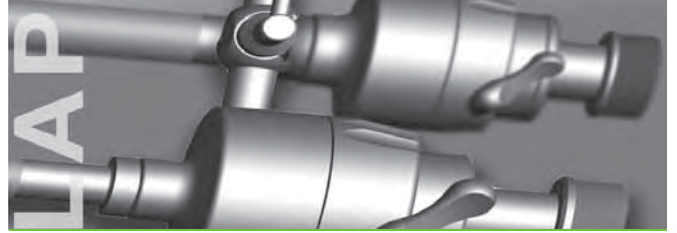

## VERESS insufflation cannulas

| Art.Nr. | Description  | Size     | Spez. |
|---------|--|----------|-------|
|         | VERESS insufflation cannula with Luer Lock connector | Ø 2,0 mm |       |



|            |           |
|------------|-----------|
| 618-510-05 | FL 55 mm  |
| 618-510-07 | FL 70 mm  |
| 618-510-08 | FL 80 mm  |
| 618-510-10 | FL 100 mm |
| 618-510-12 | FL 120 mm |
| 618-510-13 | FL 130 mm |
| 618-510-14 | FL 140 mm |
| 618-510-15 | FL 150 mm |
| 618-510-17 | FL 170 mm |
| 618-510-18 | FL 180 mm |
| 618-510-20 | FL 200 mm |
| 618-510-23 | FL 230 mm |

|   |          |
|---|----------|
| VERESS <b>HIGH FLOW</b> insufflation cannula with Luer Lock connector | Ø 2,7 mm |
|---|----------|



|            |           |
|------------|-----------|
| 618-515-10 | FL 100 mm |
| 618-515-12 | FL 120 mm |
| 618-515-15 | FL 150 mm |
| 618-515-17 | FL 170 mm |

**VERESS insufflation cannulas; STAINLESS STEEL**

| Art.Nr. | Description   | Size     | Spez. |
|---------|---|----------|-------|
|         | VERESS insufflation cannula with Luer Lock connector; stainless steel | Ø 2,0 mm |       |



- 618-550-10 FL 100 mm
- 618-550-12 FL 120 mm
- 618-550-15 FL 150 mm

|  |          |
|--|----------|
| VERESS <b>HIGH FLOW</b> insufflation cannula with Luer Lock connector; stainless steel | Ø 2,7 mm |
|--|----------|



- 618-555-10 FL 100 mm
- 618-555-12 FL 120 mm
- 618-555-15 FL 150 mm



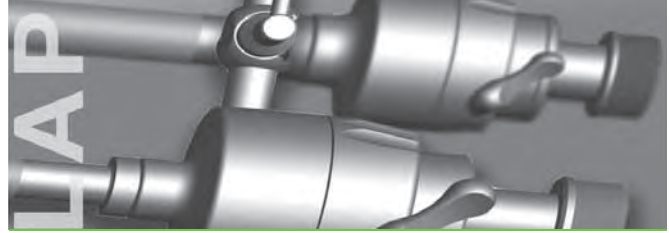

Trocar system;  
**Ø 5,5 mm** manual opening lever; for Ø 5,0 mm instruments; FL 95 mm

| Art.Nr.    | Description                                | Size               | Spez.       |
|------------|--|--------------------|-------------|
| 626-121-51 | trocar sleeve; smooth metal tube           | Ø 5,5 mm; FL 95 mm |             |
|            |  |                    |             |
| 626-122-51 | trocar sleeve; retaining thread metal tube | Ø 5,5 mm; FL 95 mm |             |
|            |  |                    |             |
| 626-175-50 | trocar stop; retaining thread              | Ø 5,5 mm; FL 35 mm |             |
|            |  |                    |             |
| 626-170-50 | sealing cap Ø 5,5 mm (red)                 |                    | 10 pcs./box |
|            |  |                    |             |
| 626-171-50 | spare part set                             |                    | 10 pcs./box |

Trocar system;  
 Ø 5,5 mm; FL 95 mm

| Art.Nr.    | Description                                  | Size                   | Spez. |
|------------|--|------------------------|-------|
| 626-151-51 | trocar; conical tip                          | Ø 5,5 mm; for FL 95 mm |       |
| 626-150-51 | trocar; conical tip; with hole               | Ø 5,5 mm; for FL 95 mm |       |
| 626-152-51 | trocar; pyramidal tip                        | Ø 5,5 mm; for FL 95 mm |       |
| 626-153-51 | trocar pyramidal; hollow grinding; with hole | Ø 5,5 mm; for FL 95 mm |       |

|            |                   |                        |  |
|------------|-------------------|------------------------|--|
| 626-154-51 | protection trocar | Ø 5,5 mm; for FL 95 mm |  |
|------------|-------------------|------------------------|--|



|            |                          |                        |  |
|------------|--------------------------|------------------------|--|
| 626-155-51 | safety trocar; pyramidal | Ø 5,5 mm; for FL 95 mm |  |
|------------|--------------------------|------------------------|--|



|            |                          |                        |  |
|------------|--------------------------|------------------------|--|
| 626-156-51 | safety trocar with knife | Ø 5,5 mm; for FL 95 mm |  |
|------------|--------------------------|------------------------|--|



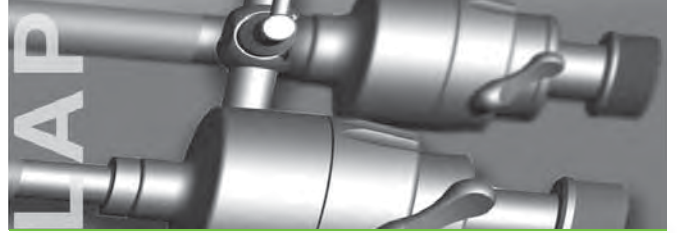



**Trocar system;**

**Ø 5,5 mm** manual opening lever; for Ø 5,0 mm instruments; **FL 150 mm**

| Art.Nr.    | Description                      | Size                | Spez. |
|------------|----------------------------------|---------------------|-------|
| 626-212-59 | trocar sleeve; smooth metal tube | Ø 5,5 mm; FL 150 mm |       |
|            |                                  |                     |       |
| 626-175-50 | trocar stop; retaining thread    | Ø 5,5 mm; FL 35 mm  |       |
|            |                                  |                     |       |
| 626-170-50 | sealing cap Ø 5,5 mm (red)       | 10 pcs./box         |       |
|            |                                  |                     |       |
| 626-171-50 | spare part set                   | 10 pcs./box         |       |
|            |                                  |                     |       |

**Trocar system;**

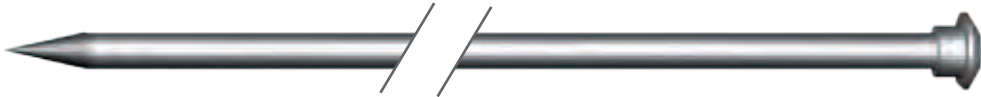
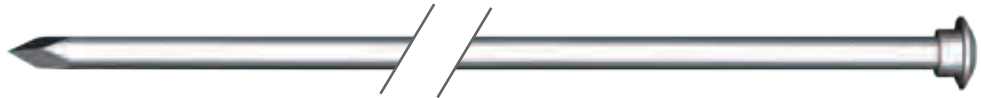
**Ø 5,5 mm; FL 150 mm**

| Art.Nr.  | Description              | Size                    | Spez. |
|--|--------------------------|-------------------------|-------|
| 626-151-59   | trocar; conical tip      | Ø 5,5 mm; for FL 150 mm |       |
|   |                          |                         |       |
| 626-152-59   | trocar; pyramidal tip    | Ø 5,5 mm; for FL 150 mm |       |
|   |                          |                         |       |
| 626-155-59   | safety trocar; pyramidal | Ø 5,5 mm; for FL 150 mm |       |
|  |                          |                         |       |

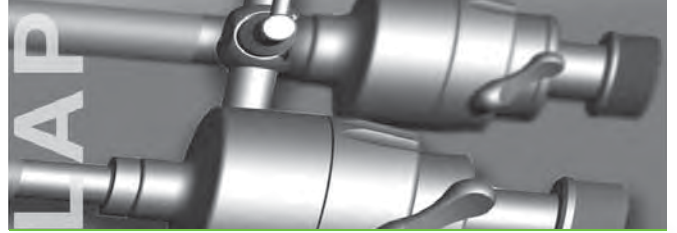

**Trocar system;**

**Ø 11,0 mm** manual opening lever; for Ø 10/11 mm instruments; FL 100 mm

| Art.Nr. | Description | Size | Spez. |
|---------|-------------|------|-------|
|---------|-------------|------|-------|

|            |                                  |                      |  |
|------------|----------------------------------|----------------------|--|
| 626-121-91 | trocar sleeve; smooth metal tube | Ø 11,0 mm; FL 100 mm |  |
|------------|----------------------------------|----------------------|--|

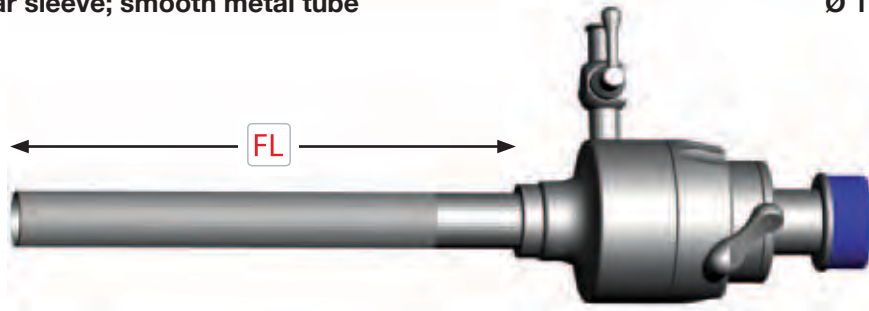

|            |  |                      |  |
|------------|--|----------------------|--|
| 626-122-91 | trocar sleeve; retaining thread metal tube | Ø 11,0 mm; FL 100 mm |  |
|------------|--|----------------------|--|

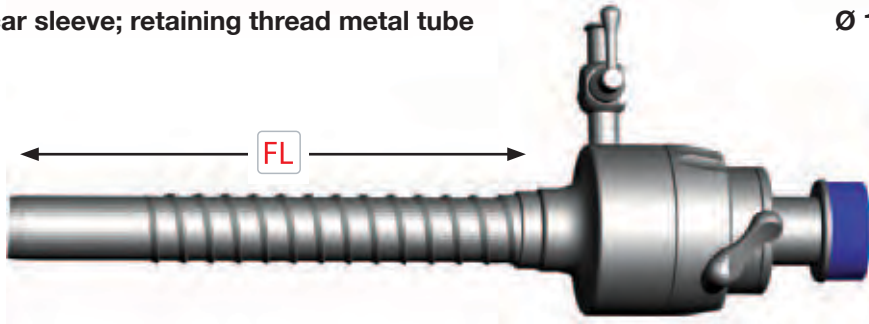

|            |                               |                     |  |
|------------|-------------------------------|---------------------|--|
| 626-175-00 | trocar stop; retaining thread | Ø 11,0 mm; FL 35 mm |  |
|------------|-------------------------------|---------------------|--|

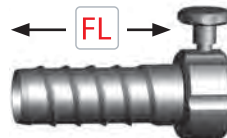

|            |                                   |  |             |
|------------|-----------------------------------|--|-------------|
| 626-170-90 | sealing cap Ø 10,0/11,0 mm (blue) |  | 10 pcs./box |
|------------|-----------------------------------|--|-------------|



|            |                |  |             |
|------------|----------------|--|-------------|
| 626-171-90 | spare part set |  | 10 pcs./box |
|------------|----------------|--|-------------|



|            |             |  |
|------------|-------------|--|
| 626-178-95 | reducer (a) | Ø 11,0 mm – 5,0 mm<br>Ø 11,0 mm – 5,0 mm |
| 626-180-95 | reducer (b) |  |

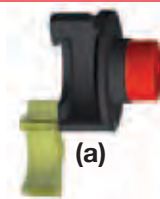







(a)



(b)

**Trocar system;**  
**Ø 11,0 mm; FL 100 mm**

| Art.Nr.  | Description                                  | Size                     | Spez. |
|--|--|--------------------------|-------|
| 626-151-91   | trocar; conical tip                          | Ø 11,0 mm; for FL 100 mm |       |
| 626-150-91   | trocar; conical tip; with hole               | Ø 11,0 mm; for FL 100 mm |       |
|     |  |                          |       |
| 626-152-91   | trocar; pyramidal tip                        | Ø 11,0 mm; for FL 100 mm |       |
|     |  |                          |       |
| 626-153-91   | trocar pyramidal; hollow grinding; with hole | Ø 11,0 mm; for FL 100 mm |       |
|   |  |                          |       |
| 626-154-91   | protection trocar                            | Ø 11,0 mm; for FL 100 mm |       |
|  |  |                          |       |
| 626-155-91   | safety trocar; pyramidal                     | Ø 11,0 mm; for FL 100 mm |       |
|  |  |                          |       |
| 626-156-91   | safety trocar with knife                     | Ø 11,0 mm; for FL 100 mm |       |
|  |  |                          |       |
| 626-182-95   | reducer sleeve                               | Ø 11,0 mm – 5,0 mm       |       |
|   |  |                          |       |

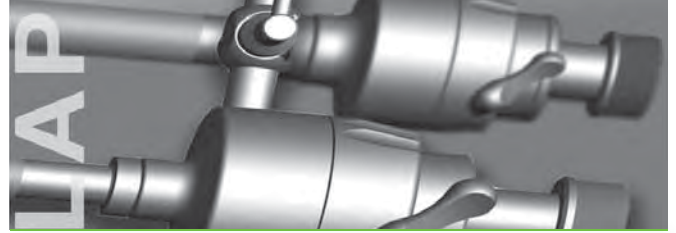





**Trocar system;**

**Ø 11,0 mm** manual opening lever; for Ø 10/11 mm instruments; **FL 150 mm**

| Art.Nr.    | Description                       | Size                 | Spez.       |
|------------|-----------------------------------|----------------------|-------------|
| 626-121-99 | trocar sleeve; smooth metal tube  | Ø 11,0 mm; FL 150 mm |             |
|            |                                   |                      |             |
| 626-175-00 | trocar stop; retaining thread     | Ø 11,0 mm; FL 35 mm  |             |
|            |                                   |                      |             |
| 626-170-90 | sealing cap Ø 10,0/11,0 mm (blue) |                      | 10 pcs./box |
|            |                                   |                      |             |
| 626-171-90 | spare part set                    |                      | 10 pcs./box |
|            |                                   |                      |             |
| 626-178-95 | reducer (a)                       | Ø 11,0 mm – 5,0 mm   |             |
| 626-180-95 | reducer (b)                       | Ø 11,0 mm – 5,0 mm   |             |
|            |                                   |                      |             |

**Trocar system;**

**Ø 11,0 mm; FL 150 mm**



| Art.Nr.   | Description                                  | Size                     | Spez. |
|---|--|--------------------------|-------|
| 626-151-99  | trocar; conical tip                          | Ø 11,0 mm; for FL 150 mm |       |
|    |  |                          |       |
| 626-152-99  | trocar; pyramidal tip                        | Ø 11,0 mm; for FL 150 mm |       |
|    |  |                          |       |
| 626-153-99  | trocar pyramidal; hollow grinding; with hole | Ø 11,0 mm; for FL 150 mm |       |
|   |  |                          |       |
| 626-155-99  | safety trocar; pyramidal                     | Ø 11,0 mm; for FL 150 mm |       |
|  |  |                          |       |
| 626-182-95  | reducer sleeve                               | Ø 11,0 mm – 5,0 mm       |       |
|  |  |                          |       |







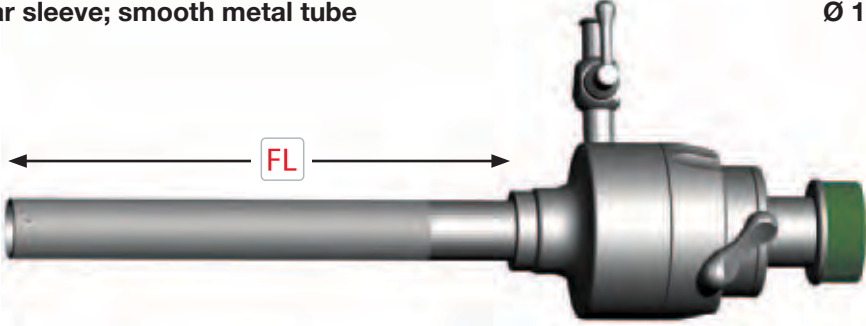
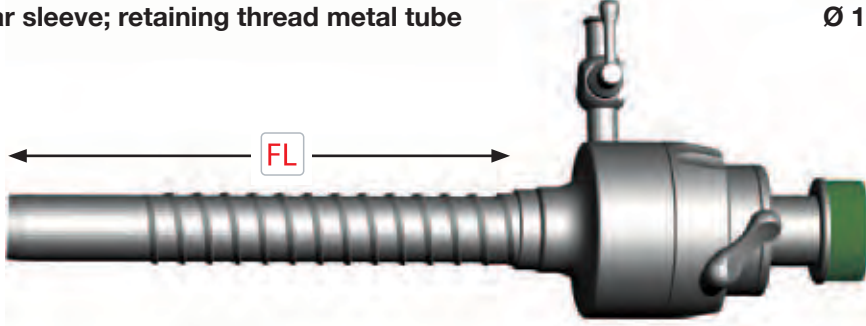
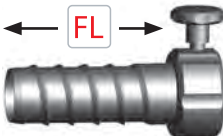

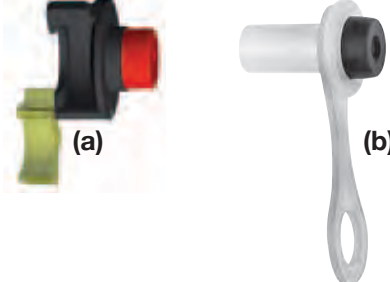

**Trocar system;**

**Ø 12,5 mm** manual opening lever; for Ø 12,5 mm instruments; FL 98 mm

| Art.Nr.    | Description   | Size                | Spez.       |
|------------|---|---------------------|-------------|
| 626-121-11 | trocar sleeve; smooth metal tube  | Ø 12,5 mm; FL 98 mm |             |
|            |     |                     |             |
| 626-122-11 | trocar sleeve; retaining thread metal tube  | Ø 12,5 mm; FL 98 mm |             |
|            |    |                     |             |
| 626-175-11 | trocar stop; retaining thread   | Ø 12,5 mm; FL 35 mm |             |
|            |    |                     |             |
| 626-170-11 | sealing cap Ø 12,5 mm (green)   |                     | 10 pcs./box |
|            |  |                     |             |
| 626-171-11 | spare part set  |                     | 10 pcs./box |
|            |  |                     |             |
| 626-178-15 | reducer (a)   | Ø 12,5 mm – 5,0 mm  |             |
| 626-180-15 | reducer (b)   | Ø 12,5 mm – 5,0 mm  |             |
|            |   |                     |             |

**Trocar system;**  
**Ø 12,5 mm; FL 98 mm**

| Art.Nr.  | Description                                  | Size                    | Spez. |
|--|--|-------------------------|-------|
| 626-151-11   | trocar; conical tip                          | Ø 12,5 mm; for FL 98 mm |       |
| 626-150-11   | trocar; conical tip; with hole               | Ø 12,5 mm; for FL 98 mm |       |
|     |  |                         |       |
| 626-152-11   | trocar; pyramidal tip                        | Ø 12,5 mm; for FL 98 mm |       |
|     |  |                         |       |
| 626-153-11   | trocar pyramidal; hollow grinding; with hole | Ø 12,5 mm; for FL 98 mm |       |
|   |  |                         |       |
| 626-154-11   | protection trocar                            | Ø 12,5 mm; for FL 98 mm |       |
|  |  |                         |       |
| 626-155-11   | safety trocar; pyramidal                     | Ø 12,5 mm; for FL 98 mm |       |
|   |  |                         |       |
| 626-156-11   | safety trocar with knife                     | Ø 12,5 mm; for FL 98 mm |       |
|  |  |                         |       |
| 626-182-15   | reducer sleeve                               | Ø 12,5 mm – 5,0 mm      |       |
|   |  |                         |       |

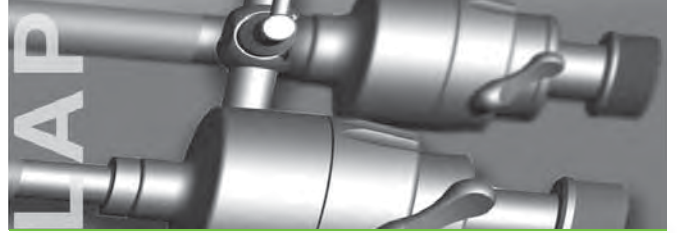

**Trocar system;**

**Ø 12,5 mm** manual opening lever; for Ø 12,5 mm instruments; **FL 150 mm**

| Art.Nr.    | Description                      | Size                 | Spez. |
|------------|----------------------------------|----------------------|-------|
| 626-121-19 | trocar sleeve; smooth metal tube | Ø 12,5 mm; FL 150 mm |       |

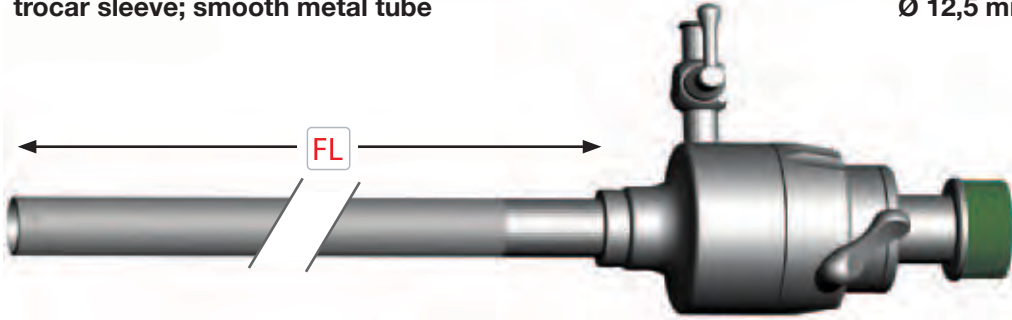

|            |                               |                     |  |
|------------|-------------------------------|---------------------|--|
| 626-175-11 | trocar stop; retaining thread | Ø 12,5 mm; FL 35 mm |  |
|------------|-------------------------------|---------------------|--|

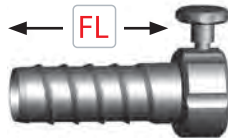

|            |                               |  |             |
|------------|-------------------------------|--|-------------|
| 626-170-11 | sealing cap Ø 12,5 mm (green) |  | 10 pcs./box |
|------------|-------------------------------|--|-------------|



|            |                |  |             |
|------------|----------------|--|-------------|
| 626-171-11 | spare part set |  | 10 pcs./box |
|------------|----------------|--|-------------|



|            |             |                    |  |
|------------|-------------|--------------------|--|
| 626-178-15 | reducer (a) | Ø 12,5 mm – 5,0 mm |  |
| 626-180-15 | reducer (b) |                    |  |

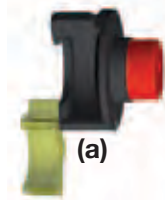

**Trocar system;**

**Ø 12,5 mm; FL 150 mm**

| Art.Nr.    | Description                                  | Size                     | Spez. |
|------------|--|--------------------------|-------|
| 626-151-19 | trocar; conical tip                          | Ø 12,5 mm; for FL 150 mm |       |
| 626-152-19 | trocar; pyramidal tip                        | Ø 12,5 mm; for FL 150 mm |       |
| 626-153-19 | trocar pyramidal; hollow grinding; with hole | Ø 12,5 mm; for FL 150 mm |       |
| 626-155-19 | safety trocar; pyramidal                     | Ø 12,5 mm; for FL 150 mm |       |
| 626-182-15 | reducer sleeve                               | Ø 12,5 mm – 5,0 mm       |       |

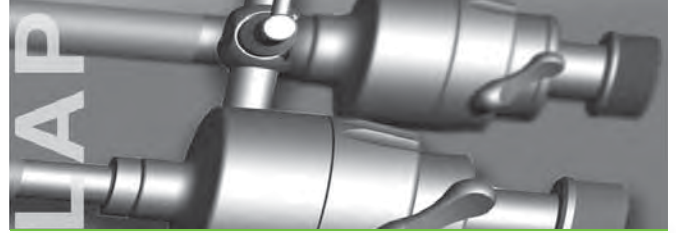

**Trocar system;**  
**Ø 15,0 mm** manual opening lever; FL 110 mm

| Art.Nr. | Description | Size | Spez. |
|---------|-------------|------|-------|
|---------|-------------|------|-------|

|            |                                  |                      |  |
|------------|----------------------------------|----------------------|--|
| 626-121-41 | trocar sleeve; smooth metal tube | Ø 15,0 mm; FL 110 mm |  |
|------------|----------------------------------|----------------------|--|

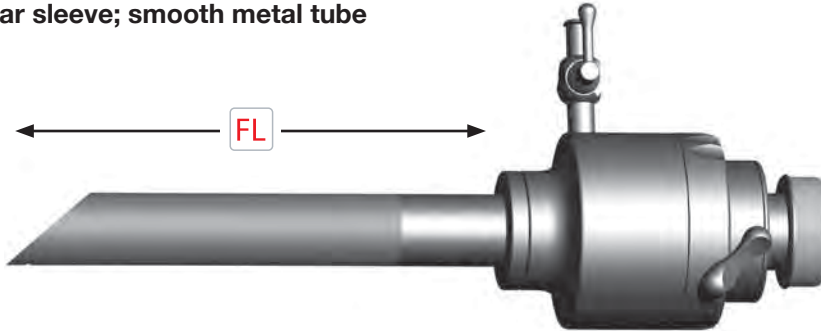

|            |                     |                          |  |
|------------|---------------------|--------------------------|--|
| 626-151-41 | trocar; conical tip | Ø 15,0 mm; for FL 110 mm |  |
|------------|---------------------|--------------------------|--|



|            |                       |                          |  |
|------------|-----------------------|--------------------------|--|
| 626-152-41 | trocar; pyramidal tip | Ø 15,0 mm; for FL 110 mm |  |
|------------|-----------------------|--------------------------|--|



|            |                                   |                  |  |
|------------|-----------------------------------|------------------|--|
| 626-179-41 | dilatations sleeve with guide rod | Ø 5,0 – 15,0 mm  |  |
| 626-179-42 | dilatations sleeve with guide rod | Ø 11,0 – 15,0 mm |  |



|            |                              |  |             |
|------------|------------------------------|--|-------------|
| 626-170-15 | sealing cap Ø 15,0 mm (grey) |  | 10 pcs./box |
|------------|------------------------------|--|-------------|



|            |                |  |             |
|------------|----------------|--|-------------|
| 626-171-15 | spare part set |  | 10 pcs./box |
|------------|----------------|--|-------------|



|            |         |                     |  |
|------------|---------|---------------------|--|
| 626-180-45 | reducer | Ø 15,0 mm – 5,0 mm  |  |
| 626-180-49 | reducer | Ø 15,0 mm – 10,0 mm |  |



**Trocar system;**  
**Ø 20,0 mm** manual opening lever; FL 119 mm

| Art.Nr.    | Description                      | Size                 | Spez. |
|------------|----------------------------------|----------------------|-------|
| 626-121-21 | Trocar sleeve; smooth metal tube | Ø 20,0 mm; FL 119 mm |       |

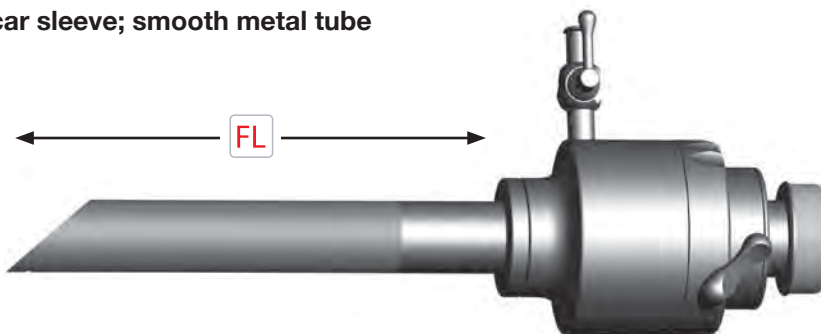

|            |                     |                          |  |
|------------|---------------------|--------------------------|--|
| 626-151-21 | trocar; conical tip | Ø 20,0 mm; for FL 119 mm |  |
|------------|---------------------|--------------------------|--|



|            |                       |                          |  |
|------------|-----------------------|--------------------------|--|
| 626-152-21 | trocar; pyramidal tip | Ø 20,0 mm; for FL 119 mm |  |
|------------|-----------------------|--------------------------|--|



|            |                                   |                     |  |
|------------|-----------------------------------|---------------------|--|
| 626-179-21 | dilatations sleeve with guide rod | Ø 5,0 mm – 20 ,0 mm |  |
| 626-179-22 | dilatations sleeve with guide rod | Ø 11,0 mm – 20,0 mm |  |



|            |                              |             |  |
|------------|------------------------------|-------------|--|
| 626-170-20 | sealing cap Ø 20,0 mm (grey) | 10 pcs./box |  |
|------------|------------------------------|-------------|--|



|            |                |             |  |
|------------|----------------|-------------|--|
| 626-171-20 | spare part set | 10 pcs./box |  |
|------------|----------------|-------------|--|



|            |         |                     |  |
|------------|---------|---------------------|--|
| 626-180-25 | reducer | Ø 20,0 mm – 5,0 mm  |  |
| 626-180-29 | reducer | Ø 20,0 mm – 10,0 mm |  |





Laparoscopy telescopes suitable for **HD-SYSTEMS**;  
designed and optimized



| Art.Nr.    | Description                | Size              | Spez.   |
|------------|----------------------------|-------------------|---|
| 601-010-09 | HD-telescope; autoclavable | Ø 10,0 mm; 340 mm | 0°  |
|            |                            |                   |    |
| 601-010-39 | HD-telescope; autoclavable | Ø 10,0 mm; 340 mm | 30°   |
|            |                            |                   |  |
| 601-010-49 | HD-telescope; autoclavable | Ø 10,0 mm; 340 mm | 45°   |
|            |                            |                   |  |
| 601-005-09 | HD-telescope; autoclavable | Ø 5,0 mm; 300 mm  | 0°  |
|            |                            |                   |  |
| 601-005-39 | HD-telescope; autoclavable | Ø 5,0 mm; 300 mm  | 30°   |
|            |                            |                   |  |

## Light guide cables

| Art.Nr.    | Description  | Size              | Spez. |
|------------|--|-------------------|-------|
| 540-805-18 | light cable for <b>HALOGEN light</b> source without connectors | Ø 4,8 mm; 1800 mm |       |
| 540-805-23 | light cable for <b>HALOGEN light</b> source without connectors | Ø 4,8 mm; 2300 mm |       |
| 540-805-30 | light cable for <b>HALOGEN light</b> source without connectors | Ø 4,8 mm; 3000 mm |       |



|            |  |                   |
|------------|--|-------------------|
| 540-815-18 | HTT-light cable for <b>XENON light</b> source without connectors | Ø 4,8 mm; 1800 mm |
| 540-815-23 | HTT-light cable for <b>XENON light</b> source without connectors | Ø 4,8 mm; 2300 mm |
| 540-815-30 | HTT-light cable for <b>XENON light</b> source without connectors | Ø 4,8 mm; 3000 mm |

**HTT:** High Transmission Technology

## Light cable connectors

| Art.Nr.    | Telescope-side   | Art.Nr.    | Unit-side  |
|------------|--|------------|--|
|            |               |            |                |
| 540-880-02 | Storz         | 540-890-02 | Storz          |
| 540-880-05 | Wolf, clip    | 540-890-04 | Wolf           |
| 540-880-13 | Wolf, snap    |            |  |
| 540-880-01 | ACMI/Stryker  | 540-890-01 | ACMI/ Stryker  |

other adapters on request





## Endoor laparoscopy instrument system for pediatric use Ø 3 mm

| Art.Nr.     | Description  | Size                | Spez. |
|-------------|--|---------------------|-------|
|             |  |                     |       |
|             | <p>insert complete with shaft; <b>NON-DETACHABLE</b></p> |                     |       |
| 610-500-32  | <b>METZENBAUM</b><br>scissors                            | Ø 3,0 mm; FL 220 mm |       |
| 610-542-32. | <b>MARYLAND</b><br>grasping forceps                      | Ø 3,0 mm; FL 220 mm |       |
| 610-544-32. | grasping forceps;<br>non-traumatic                       | Ø 3,0 mm; FL 220 mm |       |
| 610-546-32. | <b>COBRA</b><br>forceps                                  | Ø 3,0 mm; FL 220 mm |       |

Endoor handles see page 8

## Endoor laparoscopy instrument system for pediatric use

| Art.Nr.    | Description                      | Size               | Spez. |
|------------|----------------------------------|--------------------|-------|
| 626-121-31 | trocar sleeve; smooth metal tube | Ø 3,5 mm; FL 70 mm |       |

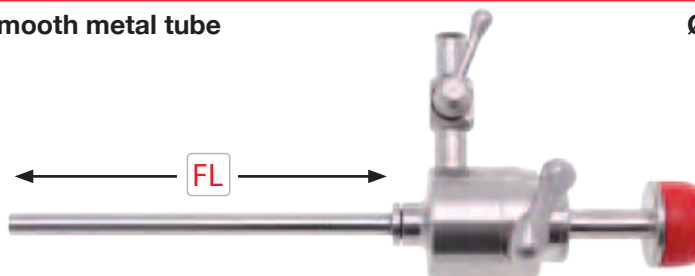

|            |                     |                        |  |
|------------|---------------------|------------------------|--|
| 626-151-31 | trocar; conical tip | Ø 3,5 mm; for FL 70 mm |  |
|------------|---------------------|------------------------|--|



|            |                       |                        |  |
|------------|-----------------------|------------------------|--|
| 626-152-31 | trocar; pyramidal tip | Ø 3,5 mm; for FL 70 mm |  |
|------------|-----------------------|------------------------|--|



## HF-laparoscopy electrodes monopolar



| Art.Nr.    | Description                 | Size                | Spez. |
|------------|-----------------------------|---------------------|-------|
| 622-005-13 | button electrode; monopolar | Ø 3,5 mm; FL 330 mm |       |



|            |                             |                     |  |
|------------|-----------------------------|---------------------|--|
| 622-005-23 | J-hook electrode; monopolar | Ø 3,5 mm; FL 330 mm |  |
|------------|-----------------------------|---------------------|--|





|            |                             |                     |  |
|------------|-----------------------------|---------------------|--|
| 622-005-33 | L-hook electrode; monopolar | Ø 3,5 mm; FL 330 mm |  |
|------------|-----------------------------|---------------------|--|



monopolar cables see page 41



**Endoor Cut;** disposable laparoscopy instrument tip-system;  
interchangeable disposable instrument tips to use with reusable handle-/shaft-system

| Art.Nr.    | Description  | Size   | Spez. |
|------------|--|--|-------|
| 610-001-00 | Endoor handle; <b>without ratchet</b>  |   |       |
| 610-005-00 | Endoor handle; <b>with ratchet</b> ;<br>ratchet can be optionally activated or deactivated |  |       |
| 610-002-95 | Endoor Cut shaft insulated with cup nut for disposable tips;<br><b>REUSABLE</b>            | Ø 5,0 mm; FL 310 mm  |       |
| 610-002-96 | Endoor Cut shaft insulated with cup nut for disposable tips;<br><b>REUSABLE</b>            | Ø 5,0 mm; FL 450 mm  |       |

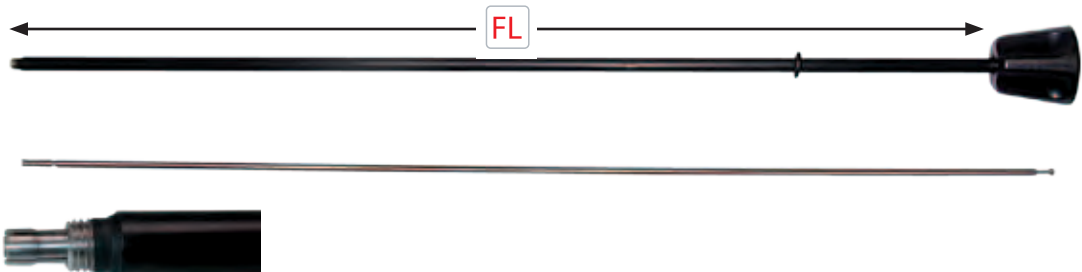

monopolar cables see page 41

**Endoor Cut;** disposable tips for laparoscopy instrument system;  
interchangeable disposable instrument tips to use with reusable handle-/shaft-system

| Art.Nr.    | Description   | Size     | Spez.      |
|------------|---|----------|------------|
| 482-900-00 | <b>METZENBAUM</b><br>tip only; disposable scissors; curved; standard blade 16 mm;<br>sterile; long insulation | Ø 5,0 mm | 5 pcs./box |
| 482-900-01 | <b>METZENBAUM</b><br>tip only; disposable scissors; curved; short blade 10 mm;<br>sterile; long insulation    | Ø 5,0 mm | 5 pcs./box |
| 482-900-02 | <b>METZENBAUM</b><br>tip only; disposable scissors; curved; long blade 20 mm;<br>sterile; long insulation     | Ø 5,0 mm | 5 pcs./box |
| 482-900-03 | <b>METZENBAUM</b><br>tip only; disposable scissors; straight blade 20 mm;<br>sterile; long insulation         | Ø 5,0 mm | 5 pcs./box |





**Endoor Cut;** disposable tips for laparoscopy instrument system;  
interchangeable disposable instrument tips to use with reusable handle-/shaft-system

| Art.Nr.    | Description   | Size     | Spez.      |
|------------|---|----------|------------|
| 482-900-10 | <b>MARYLAND</b><br>tip only; disposable dissector; curved;<br>sterile   | Ø 5,0 mm | 5 pcs./box |
| 482-900-20 | <b>MARYLAND</b><br>tip only; disposable dissector; curved;<br>sterile; long insulation                          | Ø 5,0 mm | 5 pcs./box |
| 482-900-11 | <b>ENDO CLINCH</b><br>tip only; disposable grasping forceps;<br>fenestrated; straight; sterile                  | Ø 5,0 mm | 5 pcs./box |
| 482-900-21 | <b>ENDO CLINCH</b><br>tip only; disposable grasping forceps;<br>fenestrated; straight; sterile; long insulation | Ø 5,0 mm | 5 pcs./box |
| 482-900-12 | <b>JOHANN</b><br>tip only; disposable grasping forceps  | Ø 5,0 mm | 5 pcs./box |
| 482-900-22 | <b>JOHANN</b><br>tip only; disposable grasping forceps;<br>fenestrated; sterile; long insulation                | Ø 5,0 mm | 5 pcs./box |

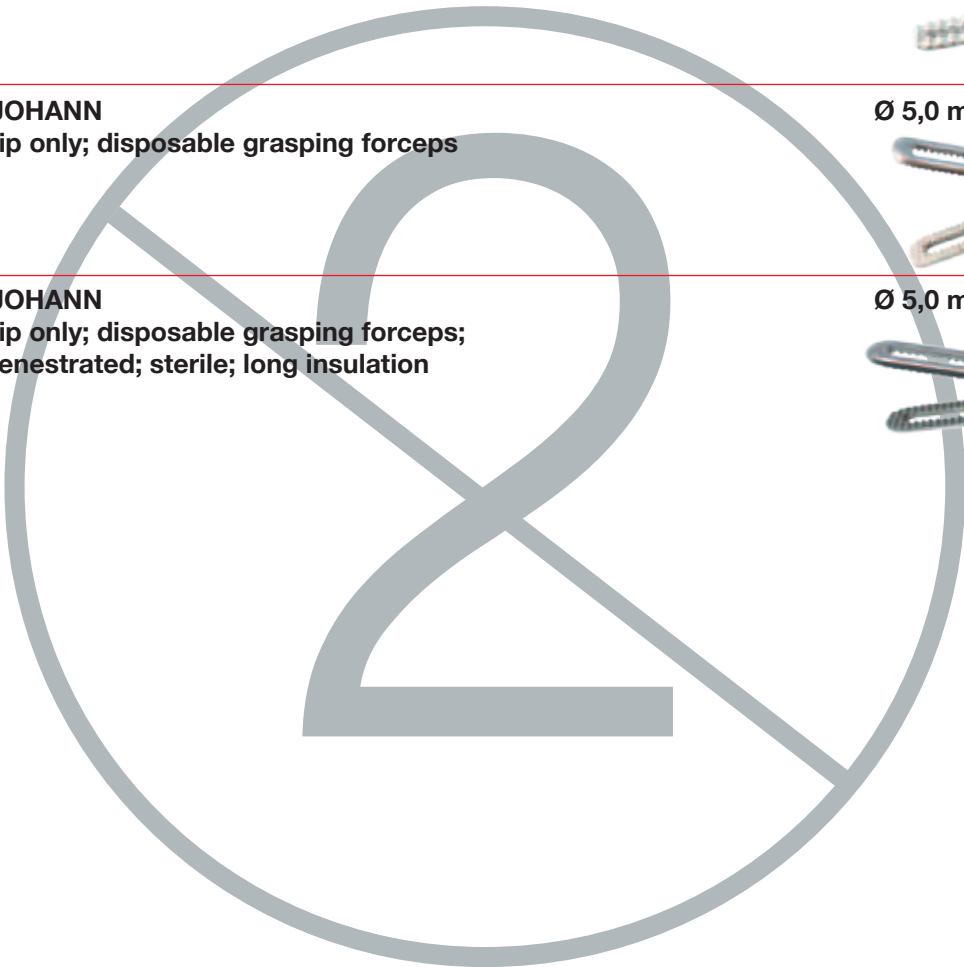

**Disposable Suction-irrigation-set;**  
disposable; sterile



| Art.Nr.    | Description  | Size | Spez.       |
|------------|--|------|-------------|
| 521-090-05 | suction-/irrigation-set;<br>3 m tubing; 2 spikes; incl. Ø 5 mm cannula;<br>disposable; sterile   |      | 20 pcs./box |
| 521-090-10 | suction-/irrigation-set;<br>3 m tubing; 2 spikes; incl. Ø 10 mm cannula;<br>disposable; sterile  |      | 20 pcs./box |
| 521-090-00 | suction-/irrigation-set;<br>3 m tubing; 2 spikes; disposable;<br>sterile; <b>without cannula</b> |      | 20 pcs./box |
| 521-090-50 | Ø 5 mm cannula only;<br>disposable; sterile  |      | 10 pcs./box |
| 521-090-51 | Ø 10 mm cannula only;<br>disposable; sterile   |      | 10 pcs./box |
| 521-090-60 | Ø 5 mm cannula only;<br><b>reusable</b>  |      | 1 pcs./box  |
| 521-090-61 | Ø 10 mm cannula only;<br><b>reusable</b>   |      | 1 pcs./box  |

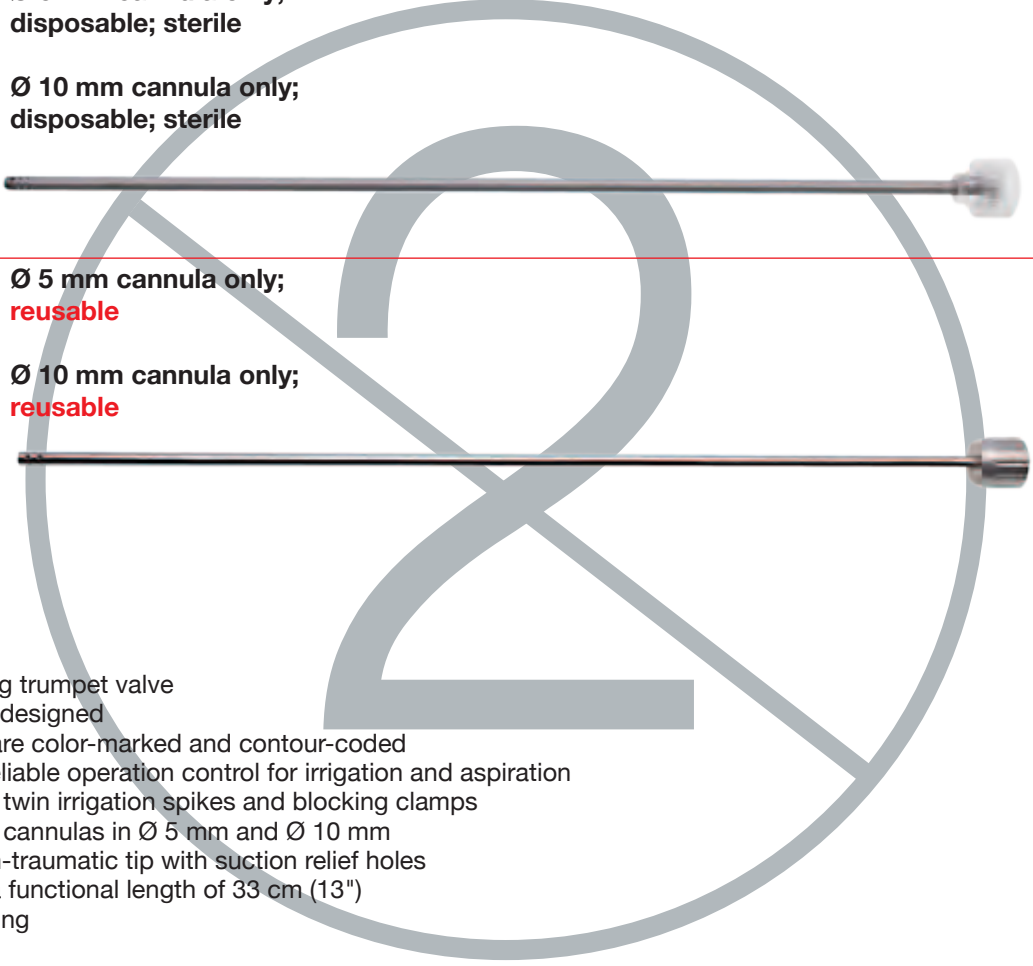

- Flow controlling trumpet valve
- Ergonomically designed
- Plunger caps are color-marked and contour-coded
- Smooth and reliable operation control for irrigation and aspiration
- Equipped with twin irrigation spikes and blocking clamps
- Stainless steel cannulas in Ø 5 mm and Ø 10 mm
- Fitted with non-traumatic tip with suction relief holes
- Cannula with a functional length of 33 cm (13")
- Sterile packaging



## Cholangiography fixation forceps

| Art.Nr. | Description  | Size                | Spez.       |
|---------|--|---------------------|-------------|
| MAS-007 | OLSEN SWAN<br>cholangiography fixation forceps; disposable | Ø 5,0 mm; FL 330 mm | 10 pcs./box |

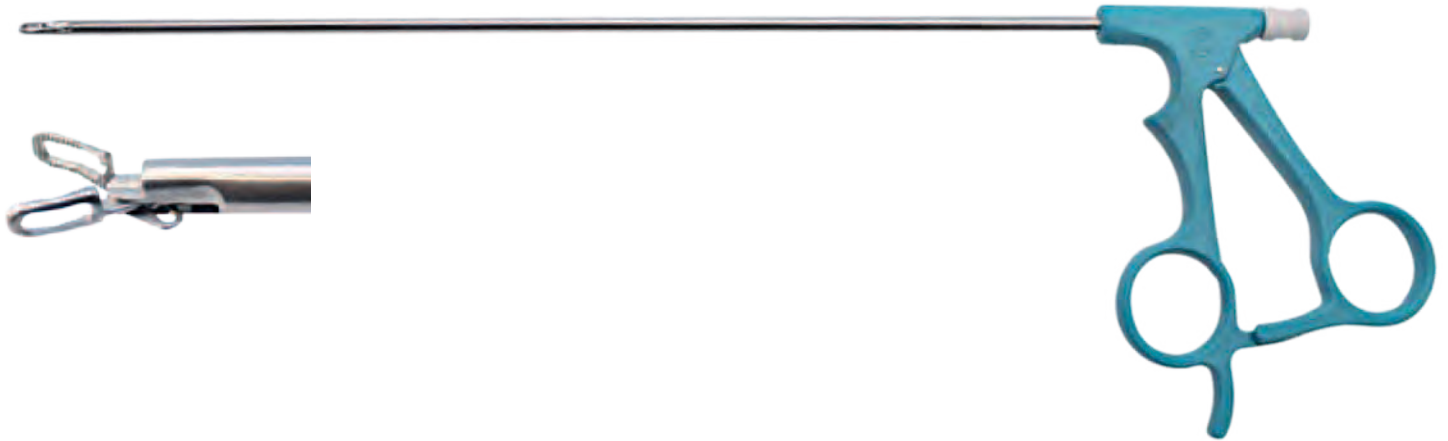

**Accessories;  
retractor for gall bladder extraction**

| <b>Art.Nr.</b> | <b>Description</b>                           | <b>Size</b> | <b>Spez.</b> |
|----------------|--|-------------|--------------|
| 527-040-00     | abdominal speculum;<br>valve inner Ø 12,0 mm |             |              |



|            |                                 |  |        |
|------------|---------------------------------|--|--------|
| 527-042-00 | s-retractor-set;<br>wide 5,5 mm |  | 2 pcs. |
|------------|---------------------------------|--|--------|

|            |                                  |  |        |
|------------|----------------------------------|--|--------|
| 527-042-11 | s-retractor-set;<br>wide 11,0 mm |  | 2 pcs. |
|------------|----------------------------------|--|--------|

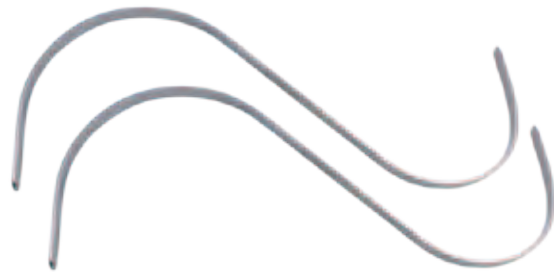





## Accessories

| Art.Nr.    | Description     | Size                | Spez. |
|------------|-----------------|---------------------|-------|
| 618-190-53 | palpation probe | Ø 5,0 mm; FL 330 mm |       |
| 618-190-54 | palpation probe | Ø 5,0 mm; FL 450 mm |       |



|            |  |  |  |
|------------|--|--|--|
| 499-100-25 | storage and sterilisation rack;<br>for 15 pieces of laparoscopy instruments;<br>Ø 5 mm or Ø 10 mm;<br>470 x 250 x 150 mm |  |  |
|------------|--|--|--|



|            |                       |  |             |
|------------|-----------------------|--|-------------|
| 087-950-01 | Luer Lock closing cap |  | 10 pcs./box |
|------------|-----------------------|--|-------------|



|            |                                |  |             |
|------------|--------------------------------|--|-------------|
| 087-955-01 | Luer Lock closing cap; silicon |  | 10 pcs./box |
|------------|--------------------------------|--|-------------|



**Accessories;  
Puncture-injection-needles**

| Art.Nr. | Description | Size     | Spez. |
|---------|-------------|----------|-------|
|         |             | Ø 5,0 mm |       |



- 618-203-07    Ø 0,7 mm needle; FL 330 mm
- 618-203-09    Ø 0,9 mm needle; FL 330 mm
- 618-203-12    Ø 1,2 mm needle; FL 330 mm
- 618-204-12    Ø 1,2 mm needle; FL 450 mm
- 618-203-14    Ø 1,4 mm needle; FL 330 mm
- 618-204-14    Ø 1,4 mm needle; FL 450 mm
- 618-203-15    Ø 1,5 mm needle; FL 330 mm
- 618-204-15    Ø 1,5 mm needle; FL 450 mm
- 618-203-18    Ø 1,8 mm needle; FL 330 mm
- 618-204-18    Ø 1,8 mm needle; FL 450 mm